

PNEUMATIKK



PNEUMATIKK- KOMPONENTER

Produktgruppe 518

FRL SKILLAIR	3
TILBEHØR SKILLAIR	14
RESERVEDELER SKILLAIR	15
FRL BIT	17
TILBEHØR BIT	20
RESERVEDELER BIT	20
FRL NEW DEAL	21
TILBEHØR NEW DEAL	26
RESERVEDELER NEW DEAL	26
PNEUMATIKK FITTINGS R	28
PNEUMATIKK FITTINGS RL FOX	33
STANDARD OVERGANGER A	38
SNITTRINGS ARMATUR B	40
RAPIDKUPLINGER C	42
BANJOKUPLINGER D	44
STRUPE-/STRUPETILBAKESLAGSVENTILER "MRFO"	45
STRUPE-/STRUPETILBAKESLAGSVENTILER "MRF"	46
REGULATORER MINIATYRFORMAT "RML" "RMS" "RMC"	49
HURTIGKUPLINGER FOR TRYKKLUFT "IAC"	50
HURTIGKUPLINGER FOR FORMSTØPINGSMASKINER "ICS"	51
HURTIGUTLUFTER "VSR"	51
MANIFOLD MED KOBLINGER	51
SLANGER OG TILBEHØR	52

SYLINDERE VENTILER PNEUMATISKE GRIPERE

Produktgruppe 517

STRUPE-/STRUPETILBAKESLAGSVENTILER IN-LINE "RFL"	48
STRUPE-/STRUPETILBAKESLAGSVENTILER M/KOBLINGER "RFL-R"	48
MINISYLINDERE ISO 6432	54
LINEÆRSTYRING FOR SYLINDERE ISO 6432	58
TILBEHØR SYLINDERE ISO 6432	59
RUNDSYLINDERE	60
TILBEHØR SYLINDERE	64
SYLINDERE ISO 6431	65
LINEÆRSTYRING FOR SYLINDERE ISO 6431	73
FESTER SYLINDERE ISO 6431	75
RESERVEDELER SYLINDERE ISO 6431	77
TILBEHØR SYLINDERE ISO 6431	78
TVILLINGSYLINDERE	79
TILBEHØR TVILLINGSYLINDERE	80
KOMPAKTSYLINDERE	81
TILBEHØR KOMPAKTSYLINDERE	87
RESERVEDELER KOMPAKTSYLINDERE	88
KOMPAKTSYLINDERE	90
TILBEHØR KOMPAKTSYLINDERE	90
RESERVEDELER KOMPAKTSYLINDERE	91
KOMPAKTGUIDER	92
TILBEHØR KOMPAKTGUIDER	93
STEMPELSTANGLØSE SYLINDERE	93
TILBEHØR STEMPELSTANGLØSE SYLINDERE	93
RESERVEDELER STEMPELSTANGLØSE SYLINDERE	93
OLJEDEMPERE	95
TILBEHØR OLJEDEMPERE	96
MINISYLINDERE KOMPAKT	96
DREIESYLINDERE	96
TILBEHØR DREIESYLINDERE	97
VENTILER SERIE 70	98
TILBEHØR VENTILER SERIE 70	100
VENTILIER SERIE 70 "BASE"	101
TILBEHØR VENTILER SERIE 70 "BASE"	101
VENTILER SERIE VME	102
FOTVENTILER	102
VENTILER SERIE ISO	102
TILBEHØR VENTILER ISO	103
DIREKTESTYRTE MAGNETVENTILER SERIE PIV	104
TILBEHØR VENTILER PIV	105
VENTILER MACH 11	107
TILBEHØR VENTILER MACH 11	107
RESERVEDELER FOR VENTILER MACH 11	107
VENTILER MACH 16	107
MULTIPOL-KONTAKTER OG TILBEHØR	110
VENTILER MACH 18	111
MULTIMACH	112
FIELDBUS	113
TILBEHØR FIELDBUS	113
BESTILLINGSNØKKELE VENTILER	114
SVIVLER OG FORDELINGSBLOKK	116
LYDDEMPERE	117
ØVRIGE VENTILER, LOGIKELEMENTER	118
PNEUMATIKK UTSTYR	119
GRIPERE	120
TILBEHØR GRIPERE	121
DREIEENHETER	122
TILBEHØR DREIEENHETER	122
SLEIDER	123
TILBEHØR SLEIDER	129

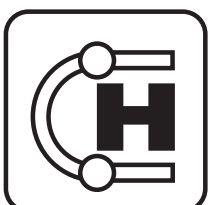



KODENØKKE

- P regulator = Presisjonsregulator (pilotregulator for regulatorer Skillair serie 400).
- Smøreapparat CA = Smøreapparat med mulighet for oljepåfylling under trykk.
- Smøreapparat ML = Smøreapparat med elektrisk nivå føler.
- Smøreapparat CAML = Smøreapparat med mulighet for oljepåfylling under trykk samt med elektrisk signal for min. oljenivå.
- Smøreapparat CD = Smøreapparat med oljepåfylling gjennom undertrykk.
- Smøreapparat CDML = Smøreapparat med oljepåfylling gjennom undertrykk samt med elektrisk signal for min. oljenivå.
- Smøreapparat CDV = Smøreapparat med automatisk oljepåfylling gjennom undertrykk samt tilkobling for fjernkontroll.
- Filter RMSA = Filter med manuell eller halvautomatisk drenering.
- Filter RA = Filter med helautomatisk drenering, flottør (større dim.)
- Filter SAC= Filter med helautomatisk drenering ved hver trykkforandring (mindre dim.)
- Samtlige ovenfornevnte kombinasjoner finnes i følgende versjoner:
 - Område:
 - 0÷2 bar, 0÷4 bar; 0÷8 bar; 0÷12 bar;
 - Filterelement: 5µ; 20µ; 50µ;
 - Drenering: manuell, halvautomatisk, helautomatisk

Artikkelnr. Benevnelse

FILTER

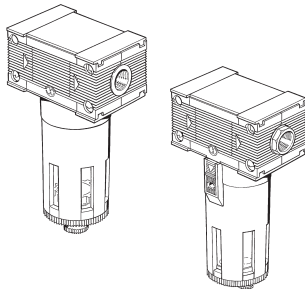

M3280001A	FIL 100 5 RMSA uten endegavler
M3280007A	FIL 100 5 SAC uten endegavler
M3280002A	FIL 100 20 uten endegavler
M3280008A	FIL 100 20 SAC uten endegavler
M3280003A	FIL 100 50 RMSA uten endegavler
M3280009A	FIL 100 50 SAC uten endegavler
M3280001	FIL 100 1/4 5 RMSA Filter
M3280007	FIL 100 1/4 5 SAC Filter
M3280002	FIL 100 1/4 20 RMSA Filter
M3280008	FIL 100 1/4 20 SAC Filter
M3280003	FIL 100 1/4 50 RMSA Filter
M3280009	FIL 100 1/4 50 SAC Filter
M3380001	FIL 100 3/8 5 RMSA Filter
M3380007	FIL 100 3/8 5 SAC Filter
M3380002	FIL 100 3/8 20 RMSA Filter
M3380008	FIL 100 3/8 20 SAC Filter
M3380003	FIL 100 3/8 50 RMSA Filter
M3380009	FIL 100 3/8 50 SAC Filter
M3480001A	FIL 200 5 RMSA uten endegavler
M3480007A	FIL 200 5 SAC uten endegavler
M3480002A	FIL 200 20 uten endegavler
M3480008A	FIL 200 20 SAC uten endegavler
M3480003A	FIL 200 50 RMSA uten endegavler
M3480009A	FIL 200 50 SAC uten endegavler
M3480001	FIL 200 1/4 5 RMSA Filter
M3480007	FIL 200 1/4 5 SAC Filter
M3480002	FIL 200 1/4 20 RMSA Filter
M3480008	FIL 200 1/4 20 SAC Filter
M3480003	FIL 200 1/4 50 RMSA Filter
M3480009	FIL 200 1/4 50 SAC Filter
M3580001	FIL 200 3/8 5 RMSA Filter
M3580007	FIL 200 3/8 5 SAC Filter
M3580002	FIL 200 3/8 20 RMSA Filter
M3580008	FIL 200 3/8 20 SAC Filter
M3580003	FIL 200 3/8 50 RMSA Filter
M3580009	FIL 200 3/8 50 SAC Filter
M3680001	FIL 200 1/2 5 RMSA Filter
M3680007	FIL 200 1/2 5 SAC Filter
M3680002	FIL 200 1/2 20 RMSA Filter
M3680008	FIL 200 1/2 20 SAC Filter
M3680003	FIL 200 1/2 50 RMSA Filter
M3680009	FIL 200 1/2 50 SAC Filter
M4480001A	FIL 300 5 RMSA uten endegavler
M4480004A	FIL 300 5 RA uten endegavler
M4480002A	FIL 300 20 RMSA uten endegavler
M4480005A	FIL 300 20 RA uten endegavler
M4480003A	FIL 300 50 RMSA uten endegavler
M4480006A	FIL 300 50 RA uten endegavler
M4480001	FIL 300 1/2 5 RMSA Filter
M4480004	FIL 300 1/2 5 RA Filter
M4480002	FIL 300 1/2 20 RMSA Filter
M4480005	FIL 300 1/2 20 RA Filter
M4480003	FIL 300 1/2 50 RMSA Filter
M4480006	FIL 300 1/2 50 RA Filter
M4580001	FIL 300 3/4 5 RMSA Filter

Artikkelnr. Benevnelse

FILTER

M4580004	FIL 300 3/4 5 RA Filter
M4580002	FIL 300 3/4 20 RMSA Filter
M4580005	FIL 300 3/4 20 RA Filter
M4580003	FIL 300 3/4 50 RMSA Filter
M4580006	FIL 300 3/4 50 RA Filter
M4680001	FIL 300 1" 5 RA Filter
M4680004	FIL 300 1" 5 RA Filter
M4680002	FIL 300 1" 20 RMSA Filter
M4680005	FIL 300 1" 20 RA Filter
M4680003	FIL 300 1" 50 RMSA Filter
M4680006	FIL 300 1" 50 RA Filter
M6180001A	FIL 400 5 RMSA uten endegavler
M6180004A	FIL 400 5 RA uten endegavler
M6180002A	FIL 400 20 RMSA uten endegavler
M6180005A	FIL 400 20 RA uten endegavler
M6180003A	FIL 400 50 RMSA uten endegavler
M6180006A	FIL 400 50 RA uten endegavler
M6180001	FIL 400 1" 5 RMSA Filter
M6180004	FIL 400 1" 5 RA Filter
M6180002	FIL 400 1" 20 RMSA Filter
M6180005	FIL 400 1" 20 RA Filter
M6180003	FIL 400 1" 50 RMSA Filter
M6180006	FIL 400 1" 50 RA Filter
M6280001	FIL 400 1 1/4 5 RMSA Filter
M6280004	FIL 400 1 1/4 5 RA Filter
M6280002	FIL 400 1 1/4 20 RMSA Filter
M6280005	FIL 400 1 1/4 20 RA Filter
M6280003	FIL 400 1 1/4 50 RMSA Filter
M6280006	FIL 400 1 1/4 50 RA Filter
M6380001	FIL 400 1 1/2 5 RMSA Filter
M6380004	FIL 400 1 1/2 5 RA Filter
M6380002	FIL 400 1 1/2 20 RMSA Filter
M6380005	FIL 400 1 1/2 20 RA Filter
M6380003	FIL 400 1 1/2 50 RMSA Filter
M6380006	FIL 400 1 1/2 50 RA Filter
M6480001	FIL 400 2" 5 RMSA Filter
M6480004	FIL 400 2" 5 RA Filter
M6480002	FIL 400 2" 20 RMSA Filter
M6480005	FIL 400 2" 20 RA Filter
M6480003	FIL 400 2" 50 RMSA Filter
M6480006	FIL 400 2" 50 RA Filter

REGULATOR

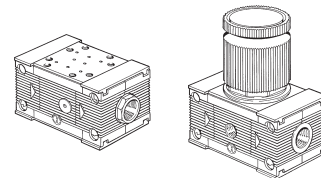

M3202001A	REG 100 02 uten endegavler
M3202002A	REG 100 04 uten endegavler
M3202003A	REG 100 08 uten endegavler
M3202004A	REG 100 012 uten endegavler
M3202001	REG 100 1/4 02 Regulator
M3202002	REG 100 1/4 04 Regulator
M3202003	REG 100 1/4 08 Regulator
M3202004	REG 100 1/4 012 Regulator
M3302001	REG 100 3/8 02 Regulator
M3302002	REG 100 3/8 04 Regulator
M3302003	REG 100 3/8 08 Regulator
M3302004	REG 100 3/8 012 Regulator
M3402001A	REG 200 02 uten endegavler
M3402002A	REG 200 04 uten endegavler
M3402003A	REG 200 08 uten endegavler
M3402004A	REG 200 012 uten endegavler

Artikkelnr. Benevnelse

REGULATOR

M3402001	REG 200 1/4 02 Regulator
M3402002	REG 200 1/4 04 Regulator
M3402003	REG 200 1/4 08 Regulator
M3402004	REG 200 1/4 012 Regulator
M3502001	REG 200 3/8 02 Regulator
M3502002	REG 200 3/8 04 Regulator
M3502003	REG 200 3/8 08 Regulator
M3502004	REG 200 3/8 012 Regulator
M3602001	REG 200 1/2 02 Regulator
M3602002	REG 200 1/2 04 Regulator
M3602003	REG 200 1/2 08 Regulator
M3602004	REG 200 1/2 012 Regulator
M4402001A	REG 300 04 uten endegavler
M4402002A	REG 300 08 uten endegavler
M4402003A	REG 300 012 uten endegavler
M4402001	REG 300 1/2 04 Regulator
M4402002	REG 300 1/2 08 Regulator
M4402003	REG 300 1/2 012 Regulator
M4502001	REG 300 3/4 04 Regulator
M4502002	REG 300 3/4 08 Regulator
M4502003	REG 300 3/4 012 Regulator
M4602001	REG 300 1" 04 Regulator
M4602002	REG 300 1" 08 Regulator
M4602003	REG 300 1" 012 Regulator
M6102001A	REG 400 uten endegavler
M6102001	REG 400 1" Regulator
M6202001	REG 400 1 1/4 Regulator
M6302001	REG 400 1 1/2 Regulator
M6402001	REG 400 2" Regulator

REGULATOR FOR BATTERIMONTERING

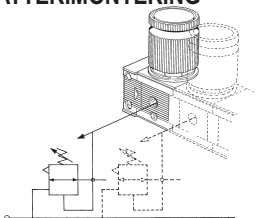

M3202101A	REG 100 0-2 Batt. uten endegavler
M3202102A	REG 100 0-4 Batt. uten endegavler
M3202103A	REG 100 08 Batt. uten endegavler
M3202104A	REG 100 0-12 Batt. uten endegavler
M3202101	REG 100 1/4 02 Batt. regulator
M3202102	REG 100 1/4 04 Batt. regulator
M3202103	REG 100 1/4 08 Batt. regulator
M3202104	REG 100 1/4 012 Batt. regulator

PILOTSTYRT REGULATOR

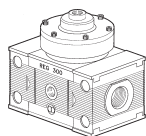

M4403003A	RP 300 uten endegavler
M4403003	RP 300 1/2 Pilotstyrt regulator
M4603003	RP 300 1" Pilotstyrt regulator

Artikkelnr. Benevnelse

PRESISJONSREGULATOR

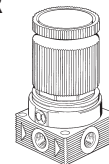

M3206001	REG P. 1/4 02 Presisjonsregulator
M3206002	REG P. 1/4 04 Presisjonsregulator
M3206003	REG P. 1/4 08 Presisjonsregulator
M3206004	REG P. 1/4 012 Presisjonsregulator

REGULATOR SKILLTRONIC



MW0214000000	SKILLTRONIC A
MW0214000100	SKILLTRONIC D

PILOT-REGULATOR SKILLTRONIC

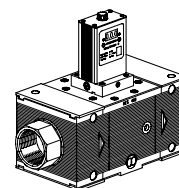

M4403010	SKILLTRONIC 300 1/2 A
M4403011	SKILLTRONIC 300 1/2 D
M4503010	SKILLTRONIC 300 3/4 A
M4503011	SKILLTRONIC 300 3/4 D
M4603010	SKILLTRONIC 300 1" A
M4603011	SKILLTRONIC 300 1" D
M6102010	SKILLTRONIC 400 1" A
M6102011	SKILLTRONIC 400 1" D
M6202010	SKILLTRONIC 400 1" 1/4 A
M6202011	SKILLTRONIC 400 1" 1/4 D
M6302010	SKILLTRONIC 400 1" 1/2 A
M6302011	SKILLTRONIC 400 1" 1/2 D
M6402010	SKILLTRONIC 400 2" A
M6402011	SKILLTRONIC 400 2" D

SMØREAPPARAT

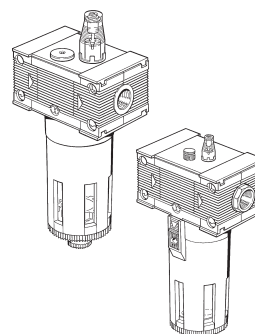

M3281001A	LUB 100 uten endegavler
M3281002A	LUB 100 CA uten endegavler
M3281005A	LUB 100 CD uten endegavler
M3281001	LUB 100 1/4

Artikkelnr. Benevnelse

SMØREAPPARAT

M3281002	LUB 100 1/4 CA
M3281005	LUB 100 1/4 CD
M3381001	LUB 100 3/8
M3381002	LUB 100 3/8 CA
M3381005	LUB 100 3/8 CD
M3481001A	LUB 200 Uten endegavler
M3481002A	LUB 200 CA Uten endegavler
M3481005A	LUB 200 CD Uten endegavler
M3481001	LUB 200 1/4
M3481002	LUB 200 1/4 CA
M3481005	LUB 200 1/4 CD
M3581001	LUB 200 3/8
M3581002	LUB 200 3/8 CA
M3581005	LUB 200 3/8 CD
M3681001	LUB 200 1/2
M3681002	LUB 200 1/2 CA
M3681005	LUB 200 1/2 CD
M4481001A	LUB 300 Uten endegavler
M4481002A	LUB 300 CA Uten endegavler
M4481003A	LUB 300 ML Uten endegavler
M4481005A	LUB 300 CD Uten endegavler
M4481006A	LUB 300 CDML Uten endegavler
M4481007A	LUB 300 CAML Uten endegavler
M4481008A	LUB 300 CD Uten endegavler
M4481001	LUB 300 1/2
M4481002	LUB 300 1/2 CA
M4481003	LUB 300 1/2 ML
M4481005	LUB 300 1/2 CD
M4481006	LUB 300 1/2 CDML
M4481007	LUB 300 1/2 CAML
M4481008	LUB 300 1/2 CDV
M4581001	LUB 300 3/4
M4581002	LUB 300 3/4 CA
M4581003	LUB 300 3/4 ML
M4581005	LUB 300 3/4 CD
M4581006	LUB 300 3/4 CDML
M4581007	LUB 300 3/4 CAML
M4581008	LUB 300 3/4 CD
M4681001	LUB 300 1"
M4681002	LUB 300 1" CA
M4681003	LUB 300 1" ML
M4681005	LUB 300 1" CD
M4681006	LUB 300 1" ML-CD
M4681007	LUB 300 1" ML-CA
M4681008	LUB 300 1" CD
M6181001A	LUB 400 Uten endegavler
M6181002A	LUB 400 CA Uten endegavler
M6181003A	LUB 400 ML Uten endegavler
M6181004A	LUB 400 CD Uten endegavler
M6181006A	LUB 400 CDML Uten endegavler
M6181007A	LUB 400 CAML Uten endegavler
M6181008A	LUB 400 CD Uten endegavler
M6181001	LUB 400 1"
M6181002	LUB 400 1" CA
M6181003	LUB 400 1" ML
M6181004	LUB 400 1" CD
M6181006	LUB 400 1" CDML
M6181007	LUB 400 1" CAML
M6181008	LUB 400 1" CD
M6281001	LUB 400 1 1/4
M6281002	LUB 400 1 1/4 CA
M6281003	LUB 400 1 1/4 ML
M6281004	LUB 400 1 1/4 CD
M6281006	LUB 400 1 1/4 CDML
M6281007	LUB 400 1 1/4 CAML
M6281008	LUB 400 1 1/4 CD

Artikkelnr. Benevnelse

SMØREAPPARAT

M6381001	LUB 400 1 1/2
M6381002	LUB 400 1 1/2 CA
M6381003	LUB 400 1 1/2 ML
M6381004	LUB 400 1 1/2 CD
M6381006	LUB 400 1 1/2 CDML
M6381007	LUB 400 1 1/2 CAML
M6381008	LUB 400 1 1/2 CD
M6481001	LUB 400 2"
M6481002	LUB 400 2" CA
M6481003	LUB 400 2" ML
M6481004	LUB 400 2" CD
M6481006	LUB 400 2" CDML
M6481007	LUB 400 2" CAML
M6481008	LUB 400 2" CD

FINFILTER

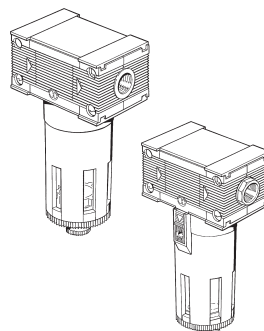

M3288001A	D 100 RMSA Uten endegavler
M3288001	D 100 1/4 RMSA Finfilter
M3388001	D 100 3/8 5 RMSA Finfilter
M3488001A	D 200 RMSA Uten endegavler
M3488001	D 200 1/4 RMSA Finfilter
M3688001	D 200 1/2 RMSA Finfilter
M3588001	D 200 3/8 5 RMSA Finfilter
M4488001A	D 300 RMSA Uten endegavler
M4488002A	D 300 RA Uten endegavler
M4488001	D 300 1/2 RMSA Finfilter
M4488002	D 300 1/2 RA Finfilter
M4588001	D 300 3/4 RMSA Finfilter
M4588002	D 300 3/4 RA Finfilter
M4688001	D 300 1" RMSA Finfilter
M4688002	D 300 1" RA Finfilter
M6188001A	D 400 5 RMSAUten endegavler
M6188002A	D 400 5 RA Uten endegavler
M6188001	D 400 1" 5 RMSA Finfilter
M6188002	D 400 1" 5 RA Finfilter
M6288001	D 400 1 1/4 RMSA Finfilter
M6288002	D 400 1 1/4 5 RA Finfilter
M6388001	D 400 1 1/2 5 RMSA Finfilter
M6388002	D 400 1 1/2 5 RA Finfilter
M6488001	D 400 2" 5 RMSA Finfilter
M6488002	D 400 2" 5 RA Finfilter



Artikkelnr. Benevnelse

FILTERREGULATOR

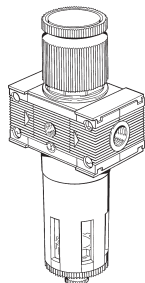

M3283007A	FR 100 5 08 RMSA uten endegavler
M3283031A	FR 100 5 08 SAC uten endegavler
M3283008A	FR 100 20 08 uten endegavler
M3283032A	FR 100 20 08 SAC uten endegavler
M3283009A	FR 100 50 08 RMSA uten endegavler
M3283033A	FR 100 50 08 SAC uten endegavler
M3283010A	FR 100 5 012 RMSA uten endegavler
M3283034A	FR 100 5 012 SAC uten endegavler
M3283011A	FR 100 20 012 RMSA uten endegavler
M3283035A	FR 100 20 012 SAC uten endegavler
M3283012A	FR 100 50 012 RMSA uten endegavler
M3283036A	FR 100 50 012 SAC uten endegavler
M3283007	FR 100 1/4 5 08 RMSA Filterreg.
M3283031	FR 100 1/4 5 08 SAC Filterreg.
M3283008	FR 100 1/4 20 08 RMSA Filterreg.
M3283032	FR 100 1/4 20 08 SAC Filterreg.
M3283009	FR 100 1/4 50 08 RMSA Filterreg.
M3283033	FR 100 1/4 50 08 SAC Filterreg.
M3283010	FR 100 1/4 5 012 RMSA Filterreg.
M3283034	FR 100 1/4 5 012 SAC Filterreg.
M3283011	FR 100 1/4 20 012 RMSA Filterreg.
M3283035	FR 100 1/4 20 012 SAC Filterreg.
M3283012	FR 100 1/4 50 012 RMSA Filterreg.
M3283036	FR 100 1/4 50 012 SAC Filterreg.
M3383007	FR 100 3/8 5 08 RMSA Filterreg.
M3383031	FR 100 3/8 5 08 SAC Filterreg.
M3383008	FR 100 3/8 20 08 RMSA Filterreg.
M3383032	FR 100 3/8 20 08 SAC Filterreg.
M3383009	FR 100 3/8 50 08 RMSA Filterreg.
M3383033	FR 100 3/8 50 08 SAC Filterreg.
M3383010	FR 100 3/8 5 012 RMSA Filterreg.
M3383034	FR 100 3/8 5 012 SAC Filterreg.
M3383011	FR 100 3/8 20 012 RMSA Filterreg.
M3383035	FR 100 3/8 20 012 SAC Filterreg.
M3383012	FR 100 3/8 50 012 RMSA Filterreg.
M3383036	FR 100 3/8 50 012 SAC Filterreg.
M3483007A	FR 200 5 08 RMSA uten endegavler
M3483031A	FR 200 5 08 SAC uten endegavler
M3483008A	FR 200 20 08 uten endegavler
M3483032A	FR 200 20 08 SAC uten endegavler
M3483009A	FR 200 50 08 RMSA uten endegavler
M3483033A	FR 200 50 08 SAC uten endegavler
M3483010A	FR 200 5 012 RMSA uten endegavler
M3483034A	FR 200 5 012 SAC uten endegavler
M3483011A	FR 200 20 012 RMSA uten endegavler
M3483035A	FR 200 20 012 SAC uten endegavler
M3483012A	FR 200 50 012 RMSA uten endegavler
M3483036A	FR 200 50 012 SAC uten endegavler
M3483007	FR 200 1/4 5 08 RMSA Filterreg.
M3483031	FR 200 1/4 5 08 SAC Filterreg.
M3483008	FR 200 1/4 20 08 RMSA Filterreg.
M3483032	FR 200 1/4 20 08 SAC Filterreg.
M3483009	FR 200 1/4 50 08 RMSA Filterreg.
M3483033	FR 200 1/4 50 08 SAC Filterreg.

Artikkelnr. Benevnelse

FILTERREGULATOR

M3483010	FR 200 1/4 5 012 RMSA Filterreg.
M3483034	FR 200 1/4 5 012 SAC Filterreg.
M3483011	FR 200 1/4 20 012 RMSA Filterreg.
M3483035	FR 200 1/4 20 012 SAC Filterreg.
M3483012	FR 200 1/4 50 012 RMSA Filterreg.
M3483036	FR 200 1/4 50 012 SAC Filterreg.
M3583007	FR 200 3/8 5 08 RMSA Filterreg.
M3583031	FR 200 3/8 5 08 SAC Filterreg.
M3583008	FR 200 3/8 20 08 RMSA Filterreg.
M3583032	FR 200 3/8 20 08 SAC Filterreg.
M3583009	FR 200 3/8 50 08 RMSA Filterreg.
M3583033	FR 200 3/8 50 08 SAC Filterreg.
M3583010	FR 200 3/8 5 012 RMSA Filterreg.
M3583034	FR 200 3/8 5 012 SAC Filterreg.
M3583011	FR 200 3/8 20 012 RMSA Filterreg.
M3583035	FR 200 3/8 20 012 SAC Filterreg.
M3583012	FR 200 3/8 50 012 RMSA Filterreg.
M3583036	FR 200 3/8 50 012 SAC Filterreg.
M3683007	FR 200 1/2 5 08 RMSA Filterreg.
M3683031	FR 200 1/2 5 08 SAC Filterreg.
M3683008	FR 200 1/2 20 08 RMSA Filterreg.
M3683032	FR 200 1/2 20 08 SAC Filterreg.
M3683009	FR 200 1/2 50 08 RMSA Filterreg.
M3683033	FR 200 1/2 50 08 SAC Filterreg.
M3683010	FR 200 1/2 5 012 RMSA Filterreg.
M3683034	FR 200 1/2 5 012 SAC Filterreg.
M3683011	FR 200 1/2 20 012 RMSA Filterreg.
M3683035	FR 200 1/2 20 012 SAC Filterreg.
M3683012	FR 200 1/2 50 012 RMSA Filterreg.
M3683036	FR 200 1/2 50 012 SAC Filterreg.
M4483004A	FR 300 5 08 RMSA uten endegavler
M4483013A	FR 300 5 08 RA uten endegavler
M4483005A	FR 300 20 08 uten endegavler
M4483014A	FR 300 20 08 RA uten endegavler
M4483006A	FR 300 50 08 RMSA uten endegavler
M4483015A	FR 300 50 08 RA uten endegavler
M4483007A	FR 300 5 012 RMSA uten endegavler
M4483016A	FR 300 5 012 RA uten endegavler
M4483008A	FR 300 20 012 RMSA uten endegavler
M4483017A	FR 300 20 012 RA uten endegavler
M4483009A	FR 300 50 012 RMSA uten endegavler
M4483018A	FR 300 50 012 RA uten endegavler
M4483004	FR 300 1/2 5 08 RMSA Filterreg.
M4483013	FR 300 1/2 5 08 RA Filterreg.
M4483005	FR 300 1/2 20 08 RMSA Filterreg.
M4483014	FR 300 1/2 20 08 RA Filterreg.
M4483006	FR 300 1/2 50 08 RMSA Filterreg.
M4483015	FR 300 1/2 50 08 RA Filterreg.
M4483007	FR 300 1/2 5 012 RMSA Filterreg.
M4483016	FR 300 1/2 5 012 RA Filterreg.
M4483008	FR 300 1/2 20 012 RMSA Filterreg.
M4483017	FR 300 1/2 20 012 RA Filterreg.
M4483009	FR 300 1/2 50 012 RMSA Filterreg.
M4483018	FR 300 1/2 50 012 RA Filterreg.
M4583004	FR 300 3/4 5 08 RMSA Filterreg.
M4583013	FR 300 3/4 5 08 RA Filterreg.
M4583005	FR 300 3/4 20 08 RMSA Filterreg.
M4583014	FR 300 3/4 20 08 RA Filterreg.
M4583006	FR 300 3/4 50 08 RMSA Filterreg.
M4583015	FR 300 3/4 50 08 RA Filterreg.
M4583007	FR 300 3/4 5 012 RMSA Filterreg.
M4583016	FR 300 3/4 5 012 RA Filterreg.
M4583008	FR 300 3/4 20 012 RMSA Filterreg.
M4583017	FR 300 3/4 20 012 RA Filterreg.
M4583009	FR 300 3/4 50 012 RMSA Filterreg.
M4583018	FR 300 3/4 50 012 RA Filterreg.

Artikkelnr. Benevnelse

FILTERREGULATOR

4683004	FR 300 1" 5 08 RMSA Filterreg.
4683013	FR 300 1" 5 08 RA Filterreg.
4683005	FR 300 1" 20 08 RMSA Filterreg.
4683014	FR 300 1" 20 08 RA Filterreg.
4683006	FR 300 1" 50 08 RMSA Filterreg.
4683015	FR 300 1" 50 08 RA Filterreg.
4683007	FR 300 1" 5 012 RMSA Filterreg.
4683016	FR 300 1" 5 012 RA Filterreg.
4683008	FR 300 1" 20 012 RMSA Filterreg.
4683017	FR 300 1" 20 012 RA Filterreg.
4683009	FR 300 1" 50 012 RMSA Filterreg.
4683018	FR 300 1" 50 012 RA Filterreg.

LUFTUTTAK

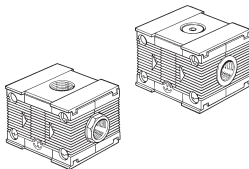

9200402A	PA 100 uten endegavler
9200402	PA 100 1/4
9300401	PA 100 3/8
9300402A	PA 200 uten endegavler
9300404	PA 200 1/2
9300402	PA 200 1/4
9300403	PA 200 3/8
9400402A	PA 300 uten endegavler
9500402	PA 300 1"
9400402	PA 300 1/2
9500401	PA 300 3/4
9700401A	PA 400 uten endegavler
9700401	PA 400 1"
9700403	PA 400 1 1/2
9700402	PA 400 1 1/4
9700404	PA 400 2"

MYKSTARTSVENTIL

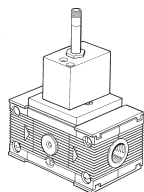

3271000A	VAP 100 uten endegavler
3271500A	VAP 100 Pneumatisk uten endegavler
3271600A	VAP 100 Elektrisk uten endegavler
3271700A	VAP 100 Elektrisk m/ ekstern styreluft uten endegavler
3271000	VAP 100 1/4 Mykstart
3271500	VAP 100 1/4 Pneumatisk
3271600	VAP 100 1/4 Elektrisk
3271700	VAP 100 1/4 Elektrisk m/ ekstern styreluft
3371000	VAP 100 3/8 Mykstart
3371500	VAP 100 3/8 Pneumatisk
3371600	VAP 100 3/8 Elektrisk
3371700	VAP 100 3/8 Elektrisk m/ ekstern styreluft

Artikkelnr. Benevnelse

PÅLUFTINGSMODUL MED NØDSTOP TYPE APR

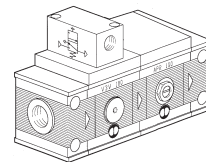

3267001A	APR 100 Pneumatisk uten endegavler
3267051A	APR 100 Elektrisk uten endegavler
3267001	APR 100 1/4 Pneumatisk
3267051	APR 100 1/4 Elektrisk
3367001	APR 100 3/8 Pneumatisk
3367051	APR 100 3/8 Elektrisk
3471000A	APR 200 Pneumatisk uten endegavler
3471001A	APR 200 Elektrisk uten endegavler
3471004A	APR 200 CNOMO Elektrisk uten endegavler
3471000	APR 200 1/4 Pneumatisk
3471001	APR 200 1/4 Elektrisk
3471004	APR 200 1/4 CNOMO Elektrisk
3571000	APR 200 3/8 Pneumatisk
3571001	APR 200 3/8 Elektrisk
3571004	APR 200 3/8 CNOMO Elektrisk
3671000	APR 200 1/2 Pneumatisk
3671001	APR 200 1/2 Elektrisk
3671004	APR 200 1/2 CNOMO Elektrisk
4471906A	APR 300 Elektrisk MICRO 24VDC uten endegavler
4471907A	APR 300 Elektrisk MICRO 24VAC uten endegavler
4471908A	APR 300 Elektrisk MICRO 110VAC uten endegavler
4471909A	APR 300 Elektrisk MICRO 220VAC uten endegavler
4471901A	APR 300 Elektrisk CNOMO uten endegavler
4471900A	APR 300 Pneumatisk uten endegavler
4471900	APR 300 1/2 Pneumatisk
4471906	APR 300 1/2 Elektrisk MICRO 24VDC
4471907	APR 300 1/2 Elektrisk MICRO 24VAC
4471908	APR 300 1/2 Elektrisk MICRO 110VAC
4471909	APR 300 1/2 Elektrisk MICRO 220VAC
4471901	APR 300 1/2 CNOMO Elektrisk
4571900	APR 300 3/4 Pneumatisk
4571906	APR 300 3/4 Elektrisk MICRO 24VDC
4571907	APR 300 3/4 Elektrisk MICRO 24VAC
4571908	APR 300 3/4 Elektrisk MICRO 110VAC
4571909	APR 300 3/4 Elektrisk MICRO 220VAC
4571901	APR 300 3/4 CNOMO Elektrisk
4671900	APR 300 1" Pneumatisk
4671906	APR 300 1" Elektrisk MICRO 24VDC
4671907	APR 300 1" Elektrisk MICRO 24VAC
4671908	APR 300 1" Elektrisk MICRO 110VAC
4671909	APR 300 1" Elektrisk MICRO 220VAC
4671901	APR 300 1" CNOMO Elektrisk
6171002A	APR 400 Pneumatisk uten endegavler
6171003A	APR 400 Elektrisk uten endegavler
6171002	APR 400 1" Pneumatisk
6171003	APR 400 1" Elektrisk
6271002	APR 400 1 1/4 Pneumatisk
6271003	APR 400 1 1/4 Elektrisk
6371002	APR 400 1 1/2 Pneumatisk
6371003	APR 400 1 1/2 Elektrisk
6471002	APR 400 2" Pneumatisk
6471003	APR 400 2" Elektrisk

Artikkelnr. Benevnelse

3-VEIS VENTIL

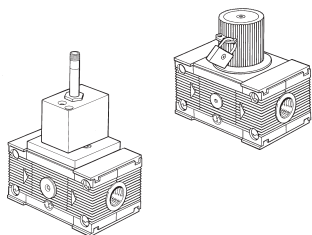

M3270001A	V3V 100 uten endegavler
M3269000A	V3V 100 Pneumatisk uten endegavler
M3269001A	V3V 100 Elektrisk uten endegavler
M3269002A	V3V 100 Elektrisk m/ ekstern styreluft uten endegavler
M3270001	V3V 100 1/4 3-veis ventil
M3269000	V3V 100 1/4 Pneumatisk
M3269001	V3V 100 1/4 Elektrisk
M3269002	V3V 100 1/4 Elektrisk m/ ekstern styreluft.
M3370001	V3V 100 3/8 3-veis ventil
M3369000	V3V 100 3/8 Pneumatisk
M3369001	V3V 100 3/8 Elektrisk
M3369002	V3V 100 3/8 Elektrisk m/ ekstern styreluft.
M3370001	V3V 100 3/8 3-veis ventil
M3369000	V3V 100 3/8 Pneumatisk
M3369001	V3V 100 3/8 Elektrisk
M3369002	V3V 100 3/8 Elektrisk m/ ekstern styreluft
M3470001A	V3V 200 uten endegavler
M3469000A	V3V PN 200 uten endegavler
M3469001A	V3V ELPN 200 uten endegavler
M3469002A	V3V 200 Elektrisk m/ ekstern styreluft uten endegavler
M3469004A	V3V 200 CNOMO Elektrisk uten endegavler
M3469005A	V3V 200 1/4 Låsbar uten endegavler
M3470001	V3V 200 1/4 3-veis ventil
M3469000	V3V 200 1/4 Pneumatisk
M3469001	V3V 200 1/4 Elektrisk
M3469002	V3V 200 1/4 Elektrisk m/ ekstern styreluft
M3469004	V3V 200 1/4 CNOMO Elektrisk
M3469005	V3V 200 1/4 CNOMO Elektrisk m/ ekstern styreluft
M3570001	V3V 200 3/8 3-veis ventil
M3569000	V3V 200 3/8 Pneumatisk
M3569001	V3V 200 3/8 Elektrisk
M3569002	V3V 200 3/8 Elektrisk m/ ekstern styreluft
M3569004	V3V 200 3/8 CNOMO Elektrisk
M3569005	V3V 200 3/8 CNOMO Elektrisk m/ ekstern styreluft
M3670001	V3V 200 1/2 3-veis ventil
M3669000	V3V 200 1/2 Pneumatisk
M3669001	V3V 200 1/2 Elektrisk
M3669002	V3V 200 1/2 Elektrisk m/ ekstern styreluft
M3669004	V3V 200 1/2 CNOMO Elektrisk
M3669005	V3V 200 1/2 CNOMO Elektrisk m/ ekstern styreluft
M4470001A	V3V 300 uten endegavle
M4469000A	V3V 300 Pneumatisk uten endegavler
M4469006A	V3V 300 Elektrisk MICRO 24VDC uten endegavler
M4469007A	V3V 300 Elektrisk MICRO 24VAC uten endegavler
M4469008A	V3V 300 Elektrisk MICRO 110VAC uten endegavler
M4469009A	V3V 300 Elektrisk MICRO 220VAC uten endegavler
M4469004A	V3V 300 CNOMO Elektrisk uten endegavler
M4469005A	V3V 300 CNOMO Elektrisk m/ ekstern styreluft u.e.g
M4470001	V3V 300 1/2 3-veis ventil
M4469000	V3V 300 1/2 Pneumatisk
M4469006	V3V 300 1/2 Elektrisk MICRO 24VDC
M4469007	V3V 300 1/2 Elektrisk MICRO 24VAC
M4469008	V3V 300 1/2 Elektrisk MICRO 110VAC
M4469009	V3V 300 1/2 Elektrisk MICRO 220VAC
M4469004	V3V 300 1/2 CNOMO Elektrisk
M4469005	V3V 300 1/2 CNOMO Elektrisk m/ ekstern styreluft
M4570001	V3V 300 3/4 3-veis ventil
M4569000	V3V 300 3/4 Pneumatisk
M4569006	V3V 300 3/4 Elektrisk MICRO 24VDC
M4569007	V3V 300 3/4 Elektrisk MICRO 24VAC
M4569008	V3V 300 3/4 Elektrisk MICRO 110VAC
M4569009	V3V 300 3/4 Elektrisk MICRO 220VAC

Artikkelnr. Benevnelse

3-VEIS VENTIL

M4569004	V3V 300 3/4 CNOMO Elektrisk
M4569005	V3V 300 3/4 CNOMO Elektrisk m/ ekstern styreluft
M4670001	V3V 300 1" 3-veis ventil
M4669000	V3V 300 1" Pneumatisk
M4669006	V3V 300 1" Elektrisk MICRO 24VDC
M4669007	V3V 300 1" Elektrisk MICRO 24VAC
M4669008	V3V 300 1" Elektrisk MICRO 110VAC
M4669009	V3V 300 1" Elektrisk MICRO 220VAC
M4669004	V3V 300 1" CNOMO Elektrisk
M4669005	V3V 300 1" CNOMO Elektrisk m/ ekstern styreluft
M6169010A	V3V 400 Nøkkellås uten endegavle
M6169000A	V3V 400 Pneumatisk uten endegavle
M6169004A	V3V 400 CNOMO Elektrisk uten endegavle
M6169005A	V3V 400 1" CNOMO Elektrisk m/ ekstern styreluft u.e.g.
M6169010	V3V 400 1" Nøkkellås
M6169000	V3V 400 1" Pneumatisk
M6169004	V3V 400 1" CNOMO Elektrisk
M6169005	V3V 400 1" CNOMO Elektrisk m/ ekstern styreluft
M6269010	V3V 400 1 1/4 Nøkkellås
M6269000	V3V 400 1 1/4 Pneumatisk
M6269004	V3V 400 1 1/4 CNOMO Elektrisk
M6269005	V3V 400 1 1/4 CNOMO Elektrisk m/ ekstern styreluft
M6369010	V3V 400 1 1/2 Nøkkellås
M6369000	V3V 400 1 1/2 Pneumatisk
M6369004	V3V 400 1 1/2 CNOMO Elektrisk
M6369005	V3V 400 1 1/2 CNOMO Elektrisk m/ ekstern styreluft
M6469010	V3V 400 2" Nøkkellås
M6469000	V3V 400 2" Pneumatisk
M6469004	V3V 400 2" CNOMO Elektrisk
M6469005	V3V 400 2" CNOMO Elektrisk m/ ekstern styreluft
M6170001A	V3V 400 uten endegavle
M6170002	V3V 400 1" Låsbar
M6170002A	V3V 400 Låsbar uten endegavle
M6270002	V3V 400 1 1/4 Låsbar
M6370002	V3V 400 1 1/2 Låsbar
M6470002	V3V 400 2" Låsbar

FILTER + FINFILTER

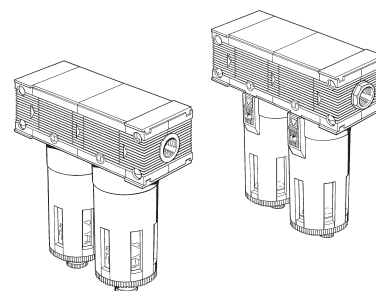

M3289001	F+D 100 1/4 5 RMSA
M3289005	F+D 100 1/4 5 SAC
M3389001	F+D 100 3/8 5 RMSA
M3389005	F+D 100 3/8 5 SAC
M3489001	F+D 200 1/4 5 RMSA
M3489005	F+D 200 1/4 5 SAC
M3589001	F+D 200 3/8 5 RMSA
M3589005	F+D 200 3/8 5 SAC
M3689001	F+D 200 1/2 5 RMSA
M3689005	F+D 200 1/2 5 SAC
M4489001	F+D 300 1/2 5 RMSA
M4489002	F+D 300 1/2 5 RA
M4589001	F+D 300 3/4 5 RMSA

Artikkelnr. Benevnelse

FILTER + FINFILTER

4589002	F+D 300 3/4 5 RA
4689001	F+D 300 1" 5 RMSA
4689002	F+D 300 1" 5 RA
6189001	F+D 400 1" 5 RMSA
6189002	F+D 400 1" 5 RA
6289001	F+D 400 1 1/4 5 RMSA
6289002	F+D 400 1 1/4 5 RA
6389001	F+D 400 1 1/2 5 RMSA
6389002	F+D 400 1 1/2 5 RA
6489001	F+D 400 2" 5 RMSA
6489002	F+D 400 2" 5 RA

FILTER + SMØREAPPARAT

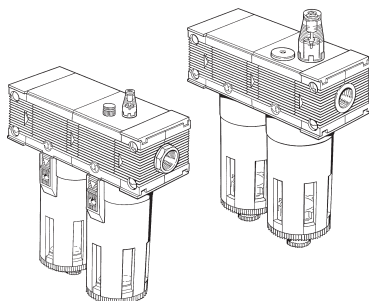

M3285001	F+L 100 1/4 5 RMSA
M3285101	F+L 100 1/4 5 SAC
M3285002	F+L 100 1/4 20 RMSA
M3285102	F+L 100 1/4 20 SAC
M3285003	F+L 100 1/4 50 RMSA
M3285103	F+L 100 1/4 50 SAC
M3385001	F+L 100 3/8 5 RMSA
M3385101	F+L 100 3/8 5 SAC
M3385002	F+L 100 3/8 20 RMSA
M3385102	F+L 100 3/8 20 SAC
M3385003	F+L 100 3/8 50 RMSA
M3385103	F+L 100 3/8 50 SAC
M3485001	F+L 200 1/4 5 RMSA
M3485101	F+L 200 1/4 5 SAC
M3485002	F+L 200 1/4 20 RMSA
M3485102	F+L 200 1/4 20 SAC
M3485003	F+L 200 1/4 50 RMSA
M3485103	F+L 200 1/4 50 SAC
M3585001	F+L 200 3/8 5 RMSA
M3585101	F+L 200 3/8 5 SAC
M3585002	F+L 200 3/8 20 RMSA
M3585102	F+L 200 3/8 20 SAC
M3585003	F+L 200 3/8 50 RMSA
M3585103	F+L 200 3/8 50 SAC
M3685001	F+L 200 1/2 5 RMSA
M3685101	F+L 200 1/2 5 SAC
M3685002	F+L 200 1/2 20 RMSA
M3685102	F+L 200 1/2 20 SAC
M3685003	F+L 200 1/2 50 RMSA
M3685103	F+L 200 1/2 50 SAC
M4485001	F+L 300 1/2 5 RMSA
M4485004	F+L 300 1/2 5 RA
M4485002	F+L 300 1/2 20 RMSA
M4485005	F+L 300 1/2 20 RA
M4485003	F+L 300 1/2 50 RMSA
M4485006	F+L 300 1/2 50 RA
M4585001	F+L 300 3/4 5 RMSA
M4585004	F+L 300 3/4 5 RA

Artikkelnr. Benevnelse

FILTER + SMØREAPPARAT

M4585002	F+L 300 3/4 20 RMSA
M4585005	F+L 300 3/4 20 RA
M4585003	F+L 300 3/4 50 RMSA
M4585006	F+L 300 3/4 50 RA
M4685001	F+L 300 1" 5 RMSA
M4685004	F+L 300 1" 5 RA
M4685002	F+L 300 1" 20 RMSA
M4685005	F+L 300 1" 20 RA
M4685003	F+L 300 1" 50 RMSA
M4685006	F+L 300 1" 50 RA
M6185001	F+L 400 1" 5 RMSA
M6185004	F+L 400 1" 5 RA
M6185002	F+L 400 1" 20 RMSA
M6185005	F+L 400 1" 20 RA
M6185003	F+L 400 1" 50 RMSA
M6185006	F+L 400 1" 50 RA
M6285001	F+L 400 1 1/4 5 RMSA
M6285004	F+L 400 1 1/4 5 RA
M6285002	F+L 400 1 1/4 20 RMSA
M6285005	F+L 400 1 1/4 20 RA
M6285003	F+L 400 1 1/4 50 RMSA
M6285006	F+L 400 1 1/4 50 RA
M6385001	F+L 400 1 1/2 5 RMSA
M6385004	F+L 400 1 1/2 5 RA
M6385002	F+L 400 1 1/2 20 RMSA
M6385005	F+L 400 1 1/2 20 RA
M6385003	F+L 400 1 1/2 50 RMSA
M6385006	F+L 400 1 1/2 50 RA
M6485001	F+L 400 2" 5 RMSA
M6485004	F+L 400 2" 5 RA
M6485002	F+L 400 2" 20 RMSA
M6485005	F+L 400 2" 20 RA
M6485003	F+L 400 2" 50 RMSA
M6485006	F+L 400 2" 50 RA

FILTERREGULATOR + SMØREAPPARAT

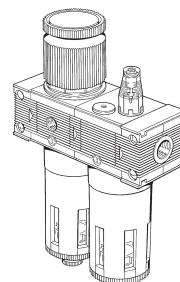

M3284007	FR+L 100 1/4 5 08 RMSA
M3284107	FR+L 100 1/4 5 08 SAC
M3284008	FR+L 100 1/4 20 08 RMSA
M3284108	FR+L 100 1/4 20 08 SAC
M3284009	FR+L 100 1/4 50 08 RMSA
M3284109	FR+L 100 1/4 50 08 SAC
M3284010	FR+L 100 1/4 5 012 RMSA
M3284110	FR+L 100 1/4 5 012 SAC
M3284011	FR+L 100 1/4 20 012 RMSA
M3284111	FR+L 100 1/4 20 012 SAC
M3284012	FR+L 100 1/4 50 012 RMSA
M3284112	FR+L 100 1/4 50 012 SAC
M3384007	FR+L 100 3/8 5 08 RMSA
M3384107	FR+L 100 3/8 5 08 SAC

Artikkelnr. Benevnelse

FILTERREGULATOR + SMØREAPPARAT

M3384008	FR+L 100 3/8 20 08 RMSA
M3384108	FR+L 100 3/8 20 08 SAC
M3384009	FR+L 100 3/8 50 08 RMSA
M3384109	FR+L 100 3/8 50 08 SAC
M3384010	FR+L 100 3/8 5 012 RMSA
M3384110	FR+L 100 3/8 5 012 SAC
M3384011	FR+L 100 3/8 20 012 RMSA
M3384111	FR+L 100 3/8 20 012 SAC
M3384012	FR+L 100 3/8 50 012 RMSA
M3384112	FR+L 100 3/8 50 012 SAC
M3484007	FR+L 200 1/4 5 08 RMSA
M3484107	FR+L 200 1/4 5 08 SAC
M3484008	FR+L 200 1/4 20 08 RMSA
M3484108	FR+L 200 1/4 20 08 SAC
M3484009	FR+L 200 1/4 50 08 RMSA
M3484109	FR+L 200 1/4 50 08 SAC
M3484010	FR+L 200 1/4 5 012 RMSA
M3484110	FR+L 200 1/4 5 012 SAC
M3484011	FR+L 200 1/4 20 012 RMSA
M3484111	FR+L 200 1/4 20 012 SAC
M3484012	FR+L 200 1/4 50 012 RMSA
M3484112	FR+L 200 1/4 50 012 SAC
M3584007	FR+L 200 3/8 5 08 RMSA
M3584107	FR+L 200 3/8 5 08 SAC
M3584008	FR+L 200 3/8 20 08 RMSA
M3584108	FR+L 200 3/8 20 08 SAC
M3584009	FR+L 200 3/8 50 08 RMSA
M3584109	FR+L 200 3/8 50 08 SAC
M3584010	FR+L 200 3/8 5 012 RMSA
M3584110	FR+L 200 3/8 5 012 SAC
M3584011	FR+L 200 3/8 20 012 RMSA
M3584111	FR+L 200 3/8 20 012 SAC
M3584012	FR+L 200 3/8 50 012 RMSA
M3584112	FR+L 200 3/8 50 012 SAC
M3684007	FR+L 200 1/2 5 08 RMSA
M3684107	FR+L 200 1/2 5 08 SAC
M3684008	FR+L 200 1/2 20 08 RMSA
M3684108	FR+L 200 1/2 20 08 SAC
M3684009	FR+L 200 1/2 50 08 RMSA
M3684109	FR+L 200 1/2 50 08 SAC
M3684010	FR+L 200 1/2 5 012 RMSA
M3684110	FR+L 200 1/2 5 012 SAC
M3684011	FR+L 200 1/2 20 012 RMSA
M3684111	FR+L 200 1/2 20 012 SAC
M3684012	FR+L 200 1/2 50 012 RMSA
M3684112	FR+L 200 1/2 50 012 SAC
M3684019	FR+L 200 1/2 5 08 RA
M3684020	FR+L 200 1/2 20 08 RA
M4484004	FR+L 300 1/2 5 08 RMSA
M4484013	FR+L 300 1/2 5 08 RA
M4484005	FR+L 300 1/2 20 08 RMSA
M4484014	FR+L 300 1/2 20 08 RA
M4484006	FR+L 300 1/2 50 08 RMSA
M4484015	FR+L 300 1/2 50 08 RA
M4484007	FR+L 300 1/2 5 012 RMSA
M4484016	FR+L 300 1/2 5 012 RA
M4484008	FR+L 300 1/2 20 012 RMSA
M4484017	FR+L 300 1/2 20 012 RA
M4484009	FR+L 300 1/2 50 012 RMSA
M4484018	FR+L 300 1/2 50 012 RA
M4584004	FR+L 300 3/4 5 08 RMSA
M4584013	FR+L 300 3/4 5 08 RA
M4584005	FR+L 300 3/4 20 08 RMSA
M4584014	FR+L 300 3/4 20 08 RA
M4584006	FR+L 300 3/4 50 08 RMSA
M4584015	FR+L 300 3/4 50 08 RA

Artikkelnr. Benevnelse

FILTERREGULATOR + SMØREAPPARAT

M4584007	FR+L 300 3/4 5 012 RMSA
M4584016	FR+L 300 3/4 5 012 RA
M4584008	FR+L 300 3/4 20 012 RMSA
M4584017	FR+L 300 3/4 20 012 RA
M4584009	FR+L 300 3/4 50 012 RMSA
M4584018	FR+L 300 3/4 50 012 RA
M4684004	FR+L 300 1 5 08 RMSA
M4684013	FR+L 300 1 5 08 RA
M4684005	FR+L 300 1 20 08 RMSA
M4684014	FR+L 300 1 20 08 RA
M4684006	FR+L 300 1 50 08 RMSA
M4684015	FR+L 300 1 50 08 RA
M4684007	FR+L 300 1 5 012 RMSA
M4684016	FR+L 300 1 5 012 RA
M4684008	FR+L 300 1 20 012 RMSA
M4684017	FR+L 300 1 20 012 RA
M4684009	FR+L 300 1 50 012 RMSA
M4684018	FR+L 300 1 50 012 RA

FILTER + REGULATOR + SMØREAPPARAT

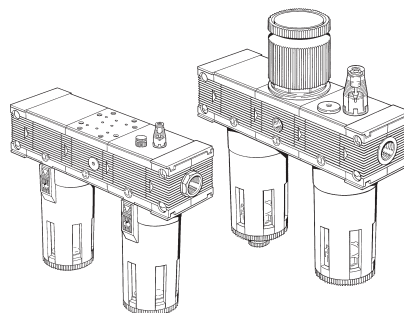

M3282007	FRL 100 1/4 5 08 RMSA
M3282107	FRL 100 1/4 5 08 SAC
M3282008	FRL 100 1/4 20 08 RMSA
M3282108	FRL 100 1/4 20 08 SAC
M3282009	FRL 100 1/4 50 08 RMSA
M3282109	FRL 100 1/4 50 08 SAC
M3282010	FRL 100 1/4 5 012 RMSA
M3282110	FRL 100 1/4 5 012 SAC
M3282011	FRL 100 1/4 20 012 RMSA
M3282111	FRL 100 1/4 20 012 SAC
M3282012	FRL 100 1/4 50 012 RMSA
M3282112	FRL 100 1/4 50 012 SAC
M3382007	FRL 100 3/8 5 08 RMSA
M3382107	FRL 100 3/8 5 08 SAC
M3382008	FRL 100 3/8 20 08 RMSA
M3382108	FRL 100 3/8 20 08 SAC
M3382009	FRL 100 3/8 50 08 RMSA
M3382109	FRL 100 3/8 50 08 SAC
M3382010	FRL 100 3/8 5 012 RMSA
M3382110	FRL 100 3/8 5 012 SAC
M3382011	FRL 100 3/8 20 012 RMSA
M3382111	FRL 100 3/8 20 012 SAC
M3382012	FRL 100 3/8 50 012 RMSA
M3382112	FRL 100 3/8 50 012 SAC
M3482007	FRL 200 1/4 5 08 RMSA
M3482107	FRL 200 1/4 5 08 SAC
M3482008	FRL 200 1/4 20 08 RMSA
M3482108	FRL 200 1/4 20 08 SAC
M3482009	FRL 200 1/4 50 08 RMSA
M3482109	FRL 200 1/4 50 08 SAC
M3482010	FRL 200 1/4 5 012 RMSA
M3482110	FRL 200 1/4 5 012 SAC

Artikkelnr. Benevnelse

FILTER + REGULATOR + SMØREAPPARAT

M3482011	FRL 200 1/4 20 012 RMSA
M3482111	FRL 200 1/4 20 012 SAC
M3482012	FRL 200 1/4 50 012 RMSA
M3482112	FRL 200 1/4 50 012 SAC
M3582007	FRL 200 3/8 5 08 RMSA
M3582107	FRL 200 3/8 5 08 SAC
M3582008	FRL 200 3/8 20 08 RMSA
M3582108	FRL 200 3/8 20 08 SAC
M3582009	FRL 200 3/8 50 08 RMSA
M3582109	FRL 200 3/8 50 08 SAC
M3582010	FRL 200 3/8 5 012 RMSA
M3582110	FRL 200 3/8 5 012 SAC
M3582011	FRL 200 3/8 20 012 RMSA
M3582111	FRL 200 3/8 20 012 SAC
M3582012	FRL 200 3/8 50 012 RMSA
M3582112	FRL 200 3/8 50 012 SAC
M3682007	FRL 200 1/2 5 08 RMSA
M3682107	FRL 200 1/2 5 08 SAC
M3682008	FRL 200 1/2 20 08 RMSA
M3682108	FRL 200 1/2 20 08 SAC
M3682009	FRL 200 1/2 50 08 RMSA
M3682109	FRL 200 1/2 50 08 SAC
M3682019	FRL 200 1/2 5 08 RA
M3682020	FRL 200 1/2 20 08 RA
M3682010	FRL 200 1/2 5 012 RMSA
M3682110	FRL 200 1/2 5 012 SAC
M3682011	FRL 200 1/2 20 012 RMSA
M3682111	FRL 200 1/2 20 012 SAC
M3682012	FRL 200 1/2 50 012 RMSA
M3682112	FRL 200 1/2 50 012 SAC
M4482004	FRL 300 1/2 5 08 RMSA
M4482005	FRL 300 1/2 20 08 RMSA
M4482006	FRL 300 1/2 50 08 RMSA
M4482007	FRL 300 1/2 5 012 RMSA
M4482008	FRL 300 1/2 20 012 RMSA
M4482009	FRL 300 1/2 50 012 RMSA
M4482013	FRL 300 1/2 5 08 RA
M4482014	FRL 300 1/2 20 08 RA
M4482015	FRL 300 1/2 50 08 RA
M4482016	FRL 300 1/2 5 012 RA
M4482017	FRL 300 1/2 20 012 RA
M4482018	FRL 300 1/2 50 012 RA
M4582004	FRL 300 3/4 5 08 RMSA
M4582005	FRL 300 3/4 20 08 RMSA
M4582006	FRL 300 3/4 50 08 RMSA
M4582007	FRL 300 3/4 5 012 RMSA
M4582008	FRL 300 3/4 20 012 RMSA
M4582009	FRL 300 3/4 50 012 RMSA
M4582013	FRL 300 3/4 5 08 RA
M4582014	FRL 300 3/4 20 08 RA
M4582015	FRL 300 3/4 50 08 RA
M4582016	FRL 300 3/4 5 012 RA
M4582017	FRL 300 3/4 20 012 RA
M4582018	FRL 300 3/4 50 012 RA
M4682004	FRL 300 1" 5 08 RMSA
M4682005	FRL 300 1" 20 08 RMSA
M4682006	FRL 300 1" 50 08 RMSA
M4682007	FRL 300 1" 5 012 RMSA
M4682008	FRL 300 1" 20 012 RMSA
M4682009	FRL 300 1" 50 012 RMSA
M4682013	FRL 300 1" 5 08 RA
M4682014	FRL 300 1" 20 08 RA
M4682015	FRL 300 1" 50 08 RA
M4682016	FRL 300 1" 5 012 RA
M4682017	FRL 300 1" 20 012 RA
M4682018	FRL 300 1" 50 012 RA

Artikkelnr. Benevnelse

FILTER + REGULATOR + SMØREAPPARAT

M6182001	FRL 400 1" 5 RMSA
M6182004	FRL 400 1" 5 RA
M6182002	FRL 400 1" 20 RMSA
M6182005	FRL 400 1" 20 RA
M6182003	FRL 400 1" 50 RMSA
M6182006	FRL 400 1" 50 RA
M6282001	FRL 400 1 1/4 5 RMSA
M6282004	FRL 400 1 1/4 5 RA
M6282002	FRL 400 1 1/4 20 RMSA
M6282005	FRL 400 1 1/4 20 RA
M6282003	FRL 400 1 1/4 50 RMSA
M6282006	FRL 400 1 1/4 50 RA
M6382001	FRL 400 1 1/2 5 RMSA
M6382004	FRL 400 1 1/2 5 RA
M6382002	FRL 400 1 1/2 20 RMSA
M6382005	FRL 400 1 1/2 20 RA
M6382003	FRL 400 1 1/2 50 RMSA
M6382006	FRL 400 1 1/2 50 RA
M6482001	FRL 400 2" 5 RMSA
M6482004	FRL 400 2" 5 RA
M6482002	FRL 400 2" 20 RMSA
M6482005	FRL 400 2" 20 RA
M6482003	FRL 400 2" 50 RMSA
M6482006	FRL 400 2" 50 RA

V3V + FILTERREGULATOR + SMØREAPPARAT

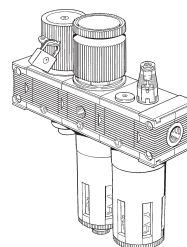

M3272007	VFR+L 100 1/4 5 08 RMSA
M3272107	VFR+L 100 1/4 5 08 SAC
M3272008	VFR+L 100 1/4 20 08 RMSA
M3272108	VFR+L 100 1/4 20 08 SAC
M3272009	VFR+L 100 1/4 50 08 RMSA
M3272109	VFR+L 100 1/4 50 08 SAC
M3272010	VFR+L 100 1/4 5 012 RMSA
M3272110	VFR+L 100 1/4 5 012 SAC
M3272011	VFR+L 100 1/4 20 012 RMSA
M3272111	VFR+L 100 1/4 20 012 SAC
M3272012	VFR+L 100 1/4 50 012 RMSA
M3272112	VFR+L 100 1/4 50 012 SAC
M3372007	VFR+L 100 3/8 5 08 RMSA
M3372107	VFR+L 100 3/8 5 08 SAC
M3372008	VFR+L 100 3/8 20 08 RMSA
M3372108	VFR+L 100 3/8 20 08 SAC
M3372009	VFR+L 100 3/8 50 08 RMSA
M3372109	VFR+L 100 3/8 50 08 SAC
M3372010	VFR+L 100 3/8 5 012 RMSA
M3372110	VFR+L 100 3/8 5 012 SAC
M3372011	VFR+L 100 3/8 20 012 RMSA
M3372111	VFR+L 100 3/8 20 012 SAC
M3372012	VFR+L 100 3/8 50 012 RMSA
M3372112	VFR+L 100 3/8 50 012 SAC
M3472007	VFR+L 200 1/4 5 08 RMSA
M3472107	VFR+L 200 1/4 5 08 SAC



Artikkelnr. Benevnelse

V3V + FILTERREGULATOR + SMØREAPPARAT

M3472008	VFR+L 200 1/4 20 08 RMSA
M3472108	VFR+L 200 1/4 20 08 SAC
M3472009	VFR+L 200 1/4 50 08 RMSA
M3472109	VFR+L 200 1/4 50 08 SAC
M3472010	VFR+L 200 1/4 5 012 RMSA
M3472110	VFR+L 200 1/4 5 012 SAC
M3472011	VFR+L 200 1/4 20 012 RMSA
M3472111	VFR+L 200 1/4 20 012 SAC
M3472012	VFR+L 200 1/4 50 012 RMSA
M3472112	VFR+L 200 1/4 50 012 SAC
M3572007	VFR+L 200 3/8 5 08 RMSA
M3572107	VFR+L 200 3/8 5 08 SAC
M3572008	VFR+L 200 3/8 20 08 RMSA
M3572108	VFR+L 200 3/8 20 08 SAC
M3572009	VFR+L 200 3/8 50 08 RMSA
M3572109	VFR+L 200 3/8 50 08 SAC
M3572010	VFR+L 200 3/8 5 012 RMSA
M3572110	VFR+L 200 3/8 5 012 SAC
M3572011	VFR+L 200 3/8 20 012 RMSA
M3572111	VFR+L 200 3/8 20 012 SAC
M3572012	VFR+L 200 3/8 50 012 RMSA
M3572112	VFR+L 200 3/8 50 012 SAC
M3672007	VFR+L 200 1/2 5 08 RMSA
M3672107	VFR+L 200 1/2 5 08 SAC
M3672008	VFR+L 200 1/2 20 08 RMSA
M3672108	VFR+L 200 1/2 20 08 SAC
M3672009	VFR+L 200 1/2 50 08 RMSA
M3672109	VFR+L 200 1/2 50 08 SAC
M3672010	VFR+L 200 1/2 5 012 RMSA
M3672110	VFR+L 200 1/2 5 012 SAC
M3672011	VFR+L 200 1/2 20 012 RMSA
M3672111	VFR+L 200 1/2 20 012 SAC
M3672012	VFR+L 200 1/2 50 012 RMSA
M3672112	VFR+L 200 1/2 50 012 SAC
M4472004	VFR+L 300 1/2 5 08 RMSA
M4472013	VFR+L 300 1/2 5 08 RA
M4472005	VFR+L 300 1/2 20 08 RMSA
M4472014	VFR+L 300 1/2 20 08 RA
M4472006	VFR+L 300 1/2 50 08 RMSA
M4472015	VFR+L 300 1/2 50 08 RA
M4472007	VFR+L 300 1/2 5 012 RMSA
M4472016	VFR+L 300 1/2 5 012 RA
M4472008	VFR+L 300 1/2 20 012 RMSA
M4472017	VFR+L 300 1/2 20 012 RA
M4472009	VFR+L 300 1/2 50 012 RMSA
M4472018	VFR+L 300 1/2 50 012 RA
M4572004	VFR+L 300 3/4 5 08 RMSA
M4572013	VFR+L 300 3/4 5 08 RA
M4572005	VFR+L 300 3/4 20 08 RMSA
M4572014	VFR+L 300 3/4 20 08 RA
M4572006	VFR+L 300 3/4 50 08 RMSA
M4572015	VFR+L 300 3/4 50 08 RA
M4572007	VFR+L 300 3/4 5 012 RMSA
M4572016	VFR+L 300 3/4 5 012 RA
M4572008	VFR+L 300 3/4 20 012 RMSA
M4572017	VFR+L 300 3/4 20 012 RA
M4572009	VFR+L 300 3/4 50 012 RMSA
M4572018	VFR+L 300 3/4 50 012 RA
M4672004	VFR+L 300 1" 5 08 RMSA
M4672013	VFR+L 300 1" 5 08 RA
M4672005	VFR+L 300 1" 20 08 RMSA
M4672014	VFR+L 300 1" 20 08 RA
M4672006	VFR+L 300 1" 50 08 RMSA
M4672015	VFR+L 300 1" 50 08 RA
M4672007	VFR+L 300 1" 5 012 RMSA
M4672016	VFR+L 300 1" 5 012 RA

Artikkelnr. Benevnelse

V3V + FILTERREGULATOR + SMØREAPPARAT

M4672008	VFR+L 300 1" 20 012 RMSA
M4672017	VFR+L 300 1" 20 012 RA
M4672009	VFR+L 300 1" 50 012 RMSA
M4672018	VFR+L 300 1" 50 012 RA

V3V + FILTER + REGULATOR + SMØREAPPARAT

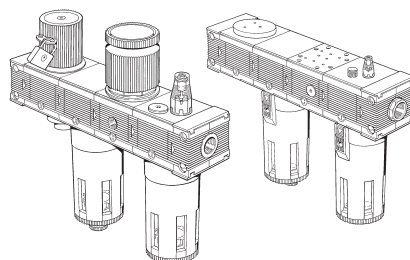

M3273007	VFRL 100 1/4 5 08 RMSA
M3273107	VFRL 100 1/4 5 08 SAC
M3273008	VFRL 100 1/4 20 08 RMSA
M3273108	VFRL 100 1/4 20 08 SAC
M3273009	VFRL 100 1/4 50 08 RMSA
M3273109	VFRL 100 1/4 50 08 SAC
M3273010	VFRL 100 1/4 5 012 RMSA
M3273110	VFRL 100 1/4 5 012 SAC
M3273011	VFRL 100 1/4 20 012 RMSA
M3273111	VFRL 100 1/4 20 012 SAC
M3273012	VFRL 100 1/4 50 012 RMSA
M3273112	VFRL 100 1/4 50 012 SAC
M3373007	VFRL 100 3/8 5 08 RMSA
M3373107	VFRL 100 3/8 5 08 SAC
M3373008	VFRL 100 3/8 20 08 RMSA
M3373108	VFRL 100 3/8 20 08 SAC
M3373009	VFRL 100 3/8 50 08 RMSA
M3373109	VFRL 100 3/8 50 08 SAC
M3373010	VFRL 100 3/8 5 012 RMSA
M3373110	VFRL 100 3/8 5 012 SAC
M3373011	VFRL 100 3/8 20 012 RMSA
M3373111	VFRL 100 3/8 20 012 SAC
M3373012	VFRL 100 3/8 50 012 RMSA
M3373112	VFRL 100 3/8 50 012 SAC
M3473007	VFRL 200 1/4 5 08 RMSA
M3473107	VFRL 200 1/4 5 08 SAC
M3473008	VFRL 200 1/4 20 08 RMSA
M3473108	VFRL 200 1/4 20 08 SAC
M3473009	VFRL 200 1/4 50 08 RMSA
M3473109	VFRL 200 1/4 50 08 SAC
M3473010	VFRL 200 1/4 5 012 RMSA
M3473110	VFRL 200 1/4 5 012 SAC
M3473011	VFRL 200 1/4 20 012 RMSA
M3473111	VFRL 200 1/4 20 012 SAC
M3473012	VFRL 200 1/4 50 012 RMSA
M3473112	VFRL 200 1/4 50 012 SAC
M3573007	VFRL 200 3/8 5 08 RMSA
M3573107	VFRL 200 3/8 5 08 SAC
M3573008	VFRL 200 3/8 20 08 RMSA
M3573108	VFRL 200 3/8 20 08 SAC
M3573009	VFRL 200 3/8 50 08 RMSA
M3573109	VFRL 200 3/8 50 08 SAC
M3573010	VFRL 200 3/8 5 012 RMSA
M3573110	VFRL 200 3/8 5 012 SAC
M3573011	VFRL 200 3/8 20 012 RMSA
M3573111	VFRL 200 3/8 20 012 SAC
M3573012	VFRL 200 3/8 50 012 RMSA
M3573112	VFRL 200 3/8 50 012 SAC



Artikkelnr. Benevnelse

V3V + FILTER + REGULATOR + SMØREAPPARAT

M3573012 VFRL 200 3/8 50 012 RMSA
M3573112 VFRL 200 3/8 50 012 SAC
M3673007 VFRL 200 1/2 5 08 RMSA
M3673107 VFRL 200 1/2 5 08 SAC
M3673008 VFRL 200 1/2 20 08 RMSA
M3673108 VFRL 200 1/2 20 08 SAC
M3673009 VFRL 200 1/2 50 08 RMSA
M3673109 VFRL 200 1/2 50 08 SAC
M3673010 VFRL 200 1/2 5 012 RMSA
M3673110 VFRL 200 1/2 5 012 SAC
M3673011 VFRL 200 1/2 20 012 RMSA
M3673111 VFRL 200 1/2 20 012 SAC
M3673012 VFRL 200 1/2 50 012 RMSA
M3673112 VFRL 200 1/2 50 012 SAC
M4473004 VFRL 300 1/2 5 08 RMSA
M4473013 VFRL 300 1/2 5 08 RA
M4473005 VFRL 300 1/2 20 08 RMSA
M4473014 VFRL 300 1/2 20 08 RA
M4473006 VFRL 300 1/2 50 08 RMSA
M4473015 VFRL 300 1/2 50 08 RA
M4473007 VFRL 300 1/2 5 012 RMSA
M4473016 VFRL 300 1/2 5 012 RA
M4473008 VFRL 300 1/2 20 012 RMSA
M4473017 VFRL 300 1/2 20 012 RA
M4473009 VFRL 300 1/2 50 012 RMSA
M4473018 VFRL 300 1/2 50 012 RA
M4573004 VFRL 300 3/4 5 08 RMSA
M4573013 VFRL 300 3/4 5 08 RA
M4573005 VFRL 300 3/4 20 08 RMSA
M4573014 VFRL 300 3/4 20 08 RA
M4573006 VFRL 300 3/4 50 08 RMSA
M4573015 VFRL 300 3/4 50 08 RA
M4573007 VFRL 300 3/4 5 012 RMSA
M4573016 VFRL 300 3/4 5 012 RA
M4573008 VFRL 300 3/4 20 012 RMSA
M4573017 VFRL 300 3/4 20 012 RA
M4573009 VFRL 300 3/4 50 012 RMSA
M4573018 VFRL 300 3/4 50 012 RA
M4673004 VFRL 300 1" 5 08 RMSA
M4673013 VFRL 300 1" 5 08 RA
M4673005 VFRL 300 1" 20 08 RMSA
M4673014 VFRL 300 1" 20 08 RA
M4673006 VFRL 300 1" 50 08 RMSA
M4673015 VFRL 300 1" 50 08 RA
M4673007 VFRL 300 1" 5 012 RMSA
M4673016 VFRL 300 1" 5 012 RA
M4673008 VFRL 300 1" 20 012 RMSA
M4673017 VFRL 300 1" 20 012 RA
M4673009 VFRL 300 1" 50 012 RMSA
M4673018 VFRL 300 1" 50 012 RA
M6173001 VFRL 400 1" 5 RMSA
M6173004 VFRL 400 1" 5 RA
M6173002 VFRL 400 1" 20 RMSA
M6173005 VFRL 400 1" 20 RA
M6173003 VFRL 400 1" 50 RMSA
M6173006 VFRL 400 1" 50 RA
M6273001 VFRL 400 1 1/4 5 RMSA
M6273004 VFRL 400 1 1/4 5 RA
M6273002 VFRL 400 1 1/4 20 RMSA
M6273005 VFRL 400 1 1/4 20 RA
M6273003 VFRL 400 1 1/4 50 RMSA
M6273006 VFRL 400 1 1/4 50 RA
M6373001 VFRL 400 1 1/2 5 RMSA
M6373004 VFRL 400 1 1/2 5 RA
M6373002 VFRL 400 1 1/2 20 RMSA
M6373005 VFRL 400 1 1/2 20 RA

Artikkelnr. Benevnelse

V3V + FILTER + REGULATOR + SMØREAPPARAT

M6373003 VFRL 400 1 1/2 50 RMSA
M6373006 VFRL 400 1 1/2 50 RA
M6473001 VFRL 400 2" 5 RMSA
M6473004 VFRL 400 2" 5 RA
M6473002 VFRL 400 2" 20 RMSA
M6473005 VFRL 400 2" 20 RA
M6473003 VFRL 400 2" 50 RMSA
M6473006 VFRL 400 2" 50 RA



Artikkelnr. Benevnelse

MONTERINGSVINKEL

M9200701 SF 100-BIT-ND 1/4 Monteringsvinkel
M9400701 SF 200-ND 3/8-1/2 Monteringsvinkel
M9400702 SF 300 Monteringsvinkel

MANOMETER

M90311160M40 1/8 0-12 Manometer
M90311115M40 1/8 0-4 Manometer
M90312160M50 1/8 0-12 Manometer
M90313160M63 1/8 0-12 Manometer

MANIFOLD FOR REGULATOR

M9200202 SB2 100 Manifold
M9300202 SB2 200 Manifold
M9400202 SB2 300 Manifold
M9200302 SB3 100 Manifold
M9300302 SB3 200 Manifold
M9400302 SB3 300 Manifold

ADAPTER

M9201801 BA 100 Adapter
M9321801 BA 200 Adapter
M9401801 BA 300 Adapter
M9301801 BA 100-200 Adapter
M9301802 BA 100-300 Adapter
M9301803 BA 200-300 Adapter

SPOLE, 30MM FOR PIV.B MAGNETVENTIL

MW0216001001 Spole 30 Ø13 10W-24VDC
MW0216001011 Spole 30 Ø13 16VA-24VAC
MW0216001021 Spole 30 Ø13 16VA-110VAC
MW0216001031 Spole 30 Ø13 16VA-220VAC

ELEKTRISK KONTAKT, 30MM PIV.B

MW0970520033 30 STD Kontakt
MW0970520034 30 LED 24V Kontakt
MW0970520035 30 LED 110V Kontakt
MW0970520036 30 LED 220V Kontakt
MW0970520037 30 LED VDR 24V Kontakt
MW0970520038 30 LED VDR 110V Kontakt
MW0970520039 30 LED VDR 220V Kontakt

SPOLE, 22MM FOR PIV.I MAGNETVENTIL, SPOLE Ø8

MW0210010100 Spole 30 Ø8 5W-24VDC
MW0210011100 Spole 30 Ø8 5VA-24VAC
MW0210012100 Spole 30 Ø8 5VA-110VAC
MW0210013100 Spole 30 Ø8 5VA-220VAC

TILBEHØR

Artikkelnr. Benevnelse

MONTERINGSSETT FOR SKILLAIR C.V

M9230301 CO 100 Monteringssett
M9330301 CO 200 Monteringssett
M9430301 CO 300 Monteringssett
M9630301 CO 400 Monteringssett

SETT FOR ENDEGAVLER

M9230401 TE INN/UT 100 1/4 Sett endegavler
M9330501 TE INN/UT 100 3/8 Sett endegavler
M9330601 TE INN/UT 200 1/4 Sett endegavler
M9330701 TE INN/UT 200 3/8 Sett endegavler
M9330801 TE INN/UT 200 1/2 Sett endegavler
M9430701 TE INN/UT 300 1/2 Sett endegavler
M9530901 TE INN/UT 300 3/4 Sett endegavler
M9531001 TE INN/UT 300 1" Sett endegavler
M9631001 TE INN/UT 400 1" Sett endegavler
M9631101 TE INN/UT 400 1 1/4" Sett endegavler
M9631201 TE INN/UT 400 1 1/2" Sett endegavler
M9631301 TE INN/UT 400 2" Sett endegavler

KONTAKT FOR REGULATOR SKILLTRONIC

MW0214100000 Hirschmann rak, N11REFS
MW0214100200 Hirschmann vinkel, N11RFF

SPOLE, 22MM TIL MAGNETVENTIL SERIE 70 SOV

MW0215000101 Spole 22 Ø8 BA 2W-24VDC
MW0215000111 Spole 22 Ø8 BA 3.6VA-24VAC
MW0215000121 Spole 22 Ø8 BA 3.6VA-110VAC
MW0215000131 Spole 22 Ø8 BA 3.6VA-220VAC
MW0215000001 Spole 22 Ø8 3.8W-24VDC
MW0215000011 Spole 22 Ø8 6.5VA-24VAC
MW0215000021 Spole 22 Ø8 6.5VA-110VAC
MW0215000031 Spole 22 Ø8 6.5VA-220VAC
MW0215000051 Spole 22 Ø8 BA 5W-12VDC

KONTAKT FOR MAGNETVENTIL SERIE 70 SOV

MW0970510011 22 STD Kontakt
MW0970510012 22 LED 24V Kontakt
MW0970510013 22 LED 110V Kontakt
MW0970510014 22 LED 220V Kontakt
MW0970510015 22 LED VDR 24V Kontakt
MW0970510016 22 LED VDR 110V Kontakt
MW0970510017 22 LED VDR 220V Kontakt

RESERVEDELER



Artikkelnr. Benevnelse

FILTERBEHOLDER

M9253301 TF 100 RMSA Filterbeholder
M9255301 TF 100 SAC Filterbeholder
M9353301 TF 200 RMSA Filterbeholder
M9355301 TF 200 SAC Filterbeholder
M9453401 TF 300 RA Filterbeholder
M9453301 TF 300 RMSA Filterbeholder
M9653401 TF 400 RA Filterbeholder
M9653301 TF 400 RMSA Filterbeholder

SMØREAPPARATBEHOLDER

M9253501 TL 100 Smøreapparatbeholder
M9202503 TL 100 CD Smøreapparatbeholder
M9202502 TL 100 ML Smøreapparatbeholder
M9202501 TL 100 CA Smøreapparatbeholder
M9353501 TL 200 Smøreapparatbeholder
M9302501 TL 200 CA Smøreapparatbeholder
M9302503 TL 200 CD Smøreapparatbeholder
M9302502 TL 200 ML Smøreapparatbeholder
M9453501 TL 300 Smøreapparatbeholder
M9202403 TL 300 CD Smøreapparatbeholder
M9202401 TL 300 CA Smøreapparatbeholder
M9202402 TL 300 ML Smøreapparatbeholder
M9653501 TL 400 Smøreapparatbeholder
M9653502 TL 400 CA Smøreapparatbeholder
M9653504 TL 400 CD Smøreapparatbeholder
M9653503 TL 400 ML Smøreapparatbeholder

FILTERELEMENT

M9251705 FP 100 5 Filterelement
M9251706 FP 100 20 Filterelement
M9251707 FP 100 50 Filterelement
M9351705 FP 200 5 Filterelement
M9351706 FP 200 20 Filterelement
M9351707 FP 200 50 Filterelement
M9451705 FP 300 5 Filterelement
M9451706 FP 300 20 Filterelement
M9451707 FP 300 50 Filterelement
M9651706 FP 400 20 Filterelement
M9651707 FP 400 50 Filterelement
M9651705 FP 400 5 Filterelement

FINFILTERELEMENT

M9251711 FP D 100 Finfilterelement
M9351711 FP D 200 Finfilterelement
M9451711 FP D 300 Finfilterelement
M9651711 FP D 400 Finfilterelement

MEMBRAN FOR SMØREAPPARAT

M9252001 MB 100-ND 1/4 Membran LUB
M9352001 MB 200 ND 3/8 1/2 Membran LUB
M9452001 MB 300 Membran LUB
M9652601 MB 400 Membran LUB

Artikkelnr. Benevnelse

SEGLASS FOR SMØREAPPARAT

M9251302 CVL 100-200-300-400-BIT Seglass

FJÆR FOR REG. OG FR

M9250605 MO 100 02 Fjær
M9250606 MO 100 04 Fjær
M9250607 MO 100 08 Fjær
M9250608 MO 100 012 Fjær
M9350605 MO 200 02 Fjær
M9350606 MO 200 04 Fjær
M9350607 MO 200 08 Fjær
M9350608 MO 200 012 Fjær
M9450605 MO 300 04 Fjær
M9450606 MO 300 08 Fjær
M9450607 MO 300 012 Fjær

JUSTERINGSENHET FOR REG. OG FR

M9250800 CS 100 02 Justeringsenhet
M9250810 CS 100 04 Justeringsenhet
M9250811 CS 100 08 Justeringsenhet
M9250812 CS 100 012 Justeringsenhet
M9350800 CS 200 02 Justeringsenhet
M9350810 CS 200 04 Justeringsenhet
M9350811 CS 200 08 Justeringsenhet
M9350812 CS 200 012 Justeringsenhet
M9450805 CS 300 04 Justeringsenhet
M9450806 CS 300 08 Justeringsenhet
M9450807 CS 300 012 Justeringsenhet

BUNNVENTIL FOR REG.

M9250704 OTR 100 Bunnventil
M9350704 OTR 200 Bunnventil
M9450704 OTR 300 Bunnventil
M9650704 OTR 400 Bunnventil

BUNNVENTIL FOR FILTERREGULATOR

M9250903 OTFR 100 20 Ventil FR
M9250902 OTFR 100 5 Ventil FR
M9250904 OTFR 100 50 Ventil FR
M9350903 OTFR 200 20 Ventil FR
M9350902 OTFR 200 5 Ventil FR
M9350904 OTFR 200 50 Ventil FR
M9450903 OTFR 300 20 Ventil FR
M9450902 OTFR 300 5 Ventil FR
M9450904 OTFR 300 50 Ventil FR

NØKKEL FOR DEMONTERING AV SEGLASS

M9220701 CS CVL 100-200-300-400-BIT Verktøy



Artikkelnr. Benevnelse

NØKKELE FOR DEMONTERING AV JUSTERINGSSEHET

M9220401 CS CS 100 Verktøy
M9323401 CS CS 200 Verktøy
M9420401 CS CS 300 Verktøy

NØKKELE FOR DEMONTERING AV BUNNVENTIL

M9220501 CS OTR 100 Verktøy
M9323501 CS OTR 200 Verktøy
M9420501 CS OTR 300 Verktøy

NØKKELE FOR DEMONTERING AV BEHOLDER FR + FIL

M9220601 CS TF-TL 100 Verktøy
M9323601 CS TF-TL 200 Verktøy
M9420601 CS TF-TL 300 Verktøy

NØKKELE FOR DEMONTERING AV VENTIL FR

M9220801 Demont. nøkkel for ventil FR 100
M9320801 Demont. nøkkel for ventil FR 200
M9420801 Demont. nøkkel for ventil FR 300

BASISPLATE FOR ELEKTRISK STYRING MICRO, APR 300

M9453601 PCE MICRO Basisplate

BASISPLATE FOR ELEKTRISK STYRING CNOMO, APR 300

M9454001 PCE CNOMO Basisplate

BASISPLATE FOR PNEUMATISK STYRING, APR 300

M9453701 PCP MICRO Basisplate

Artikkelnr. Benevnelse

MAGNETVENTIL TIL APR 300 OG V3V 300

M9453901 CNOMO 24VDC Magnetventil
M9453902 CNOMO 24V Magnetventil
M9453903 CNOMO 110V Magnetventil
M9453904 CNOMO 220V Magnetventil

MAGNETVENTIL MICRO, APR 300

M9453801 MICRO 24CC Magnetventil
M9453802 MICRO 24V Magnetventil
M9453803 MICRO 110V Magnetventil
M9453804 MICRO 220V Magnetventil

LÅSEHET FOR V3V 400

M9455401 KIT CC 400 Med nøkkel
M9455601 KIT LU 400 For hengelås

PLASTENDESTYKKE PU OG PE

M9152103 PU 100 Endestykke
M9152105 PE 100 Endestykke
M9152115 PU 200 Endestykke
M9152116 PE 200 Endestykke
M9152104 PU 300 Endestykke
M9152106 PE 300 Endestykke
M9152118 PU 400 Endestykke
M9152119 PE 400 Endestykke

PLASTMELLOMSTYKKE

M9152107 PI 100 Mellomstykke
M9152114 PI 200 Mellomstykke
M9152108 PI 300 Mellomstykke
M9152117 PI 400 Mellomstykke

AUTODREN

M9000802 RA 300-400 Autodren
M9000803 SAC 100-200-BIT Autodren

Artikkelnr. Benevnelse

FILTER

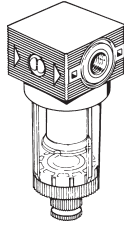

- 5101001 FIL BIT 1/8 5 RMSA Filter
- 5101004 FIL BIT 1/8 5 SAC Filter
- 5101002 FIL BIT 1/8 20 RMSA Filter
- 5101005 FIL BIT 1/8 20 SAC Filter
- 5101003 FIL BIT 1/8 50 RMSA Filter
- 5101006 FIL BIT 1/8 50 SAC Filter
- 5201001 FIL BIT 1/4 5 RMSA Filter
- 5201004 FIL BIT 1/4 5 SAC Filter
- 5201002 FIL BIT 1/4 20 RMSA Filter
- 5201005 FIL BIT 1/4 20 SAC Filter
- 5201003 FIL BIT 1/4 50 RMSA Filter
- 5201006 FIL BIT 1/4 50 SAC Filter

MINIREGULATOR (MR)

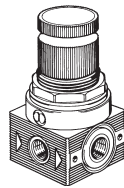

- 5107004 MR BIT 1/8 012 Regulator
- 5107001 MR BIT 1/8 02 Regulator
- 5107002 MR BIT 1/8 04 Regulator
- 5107003 MR BIT 1/8 08 Regulator
- 5207004 MR BIT 1/4 012 Regulator
- 5207001 MR BIT 1/4 02 Regulator
- 5207002 MR BIT 1/4 04 Regulator
- 5207003 MR BIT 1/4 08 Regulator

MINIREGULATOR MED KONTROLLERT AVLUFING (FC)

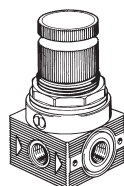

- 5111001 MR BIT FC 1/8 02 Regulator
- 5111002 MR BIT FC 1/8 04 Regulator
- 5211001 MR BIT FC 1/4 02 Regulator
- 5211002 MR BIT FC 1/4 04 Regulator

Artikkelnr. Benevnelse

MINIREGULATOR MED HURTIG AVLUFING (SR)



- 5102001 MR BIT SR 1/8 02 Regulator
- 5102002 MR BIT SR 1/8 04 Regulator
- 5102003 MR BIT SR 1/8 08 Regulator
- 5102004 MR BIT SR 1/8 012 Regulator
- 5202001 MR BIT SR 1/4 02 Regulator
- 5202002 MR BIT SR 1/4 04 Regulator
- 5202003 MR BIT SR 1/4 08 Regulator
- 5202004 MR BIT SR 1/4 012 Regulator

MINIREGULATOR FOR VANN (MRA)

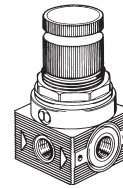

- 5108001 MRA BIT 1/8 02 Regulator
- 5108002 MRA BIT 1/8 04 Regulator
- 5108003 MRA BIT 1/8 08 Regulator
- 5108004 MRA BIT 1/8 012 Regulator
- 5208001 MRA BIT 1/4 02 Regulator
- 5208002 MRA BIT 1/4 04 Regulator
- 5208003 MRA BIT 1/4 08 Regulator
- 5208004 MRA BIT 1/4 012 Regulator

SMØREAPPARAT

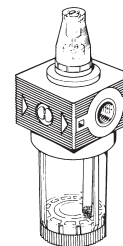

- 5103001 LUB BIT 1/8 Smøreapparat
- 5203001 LUB BIT 1/4 Smøreapparat

FINFILTER

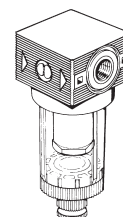

- 5112001 DEP BIT 1/8 RMSA Finfilter
- 5212001 DEP BIT 1/4 RMSA Finfilter

Artikkelnr. Benevnelse

FILTERREGULATOR

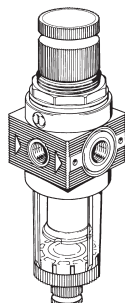

5105001	FR BIT 1/8 5 02 RMSA Filterreg.
5105013	FR BIT 1/8 5 02 SAC Filterreg.
5105002	FR BIT 1/8 20 02 RMSA Filterreg.
5105014	FR BIT 1/8 20 02 SAC Filterreg.
5105003	FR BIT 1/8 50 02 RMSA Filterreg.
5105015	FR BIT 1/8 50 02 SAC Filterreg.
5105004	FR BIT 1/8 5 04 RMSA Filterreg.
5105016	FR BIT 1/8 5 04 SAC Filterreg.
5105005	FR BIT 1/8 20 04 RMSA Filterreg.
5105017	FR BIT 1/8 20 04 SAC Filterreg.
5105006	FR BIT 1/8 50 04 RMSA Filterreg.
5105018	FR BIT 1/8 50 04 SAC Filterreg.
5105007	FR BIT 1/8 5 08 RMSA Filterreg.
5105019	FR BIT 1/8 5 08 SAC Filterreg.
5105008	FR BIT 1/8 20 08 RMSA Filterreg.
5105020	FR BIT 1/8 20 08 SAC Filterreg.
5105009	FR BIT 1/8 50 08 RMSA Filterreg.
5105021	FR BIT 1/8 50 08 SAC Filterreg.
5105010	FR BIT 1/8 5 012 RMSA Filterreg.
5105022	FR BIT 1/8 5 012 SAC Filterreg.
5105011	FR BIT 1/8 20 012 RMSA Filterreg.
5105023	FR BIT 1/8 20 012 SAC Filterreg.
5105012	FR BIT 1/8 50 012 RMSA Filterreg.
5105024	FR BIT 1/8 50 012 SAC Filterreg.
5205001	FR BIT 1/4 5 02 RMSA Filterreg.
5205013	FR BIT 1/4 5 012 SAC Filterreg.
5205002	FR BIT 1/4 20 02 RMSA Filterreg.
5205014	FR BIT 1/4 20 02 SAC Filterreg.
5205003	FR BIT 1/4 50 02 RMSA Filterreg.
5205015	FR BIT 1/4 50 02 SAC Filterreg.
5205004	FR BIT 1/4 5 04 RMSA Filterreg.
5205016	FR BIT 1/4 5 04 SAC Filterreg.
5205005	FR BIT 1/4 20 04 RMSA Filterreg.
5205017	FR BIT 1/4 20 04 SAC Filterreg.
5205006	FR BIT 1/4 50 04 RMSA Filterreg.
5205018	FR BIT 1/4 50 04 SAC Filterreg.
5205007	FR BIT 1/4 5 08 RMSA Filterreg.
5205019	FR BIT 1/4 5 08 SAC Filterreg.
5205008	FR BIT 1/4 20 08 RMSA Filterreg.
5205020	FR BIT 1/4 20 08 SAC Filterreg.
5205009	FR BIT 1/4 50 08 RMSA Filterreg.
5205021	FR BIT 1/4 50 08 SAC Filterreg.
5205010	FR BIT 1/4 5 012 RMSA Filterreg.
5205022	FR BIT 1/4 5 012 SAC Filterreg.
5205011	FR BIT 1/4 20 012 RMSA Filterreg.
5205023	FR BIT 1/4 20 012 SAC Filterreg.
5205012	FR BIT 1/4 50 012 RMSA Filterreg.
5205024	FR BIT 1/4 50 012 SAC Filterreg.

Artikkelnr. Benevnelse

FILTERREGULATOR + SMØREAPPARAT

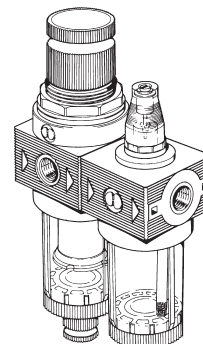

5106001	FR+L BIT 1/8 5 02 RMSA
5106013	FR+L BIT 1/8 5 02 SAC
5106004	FR+L BIT 1/8 5 04 RMSA
5106016	FR+L BIT 1/8 5 04 SAC
5106007	FR+L BIT 1/8 5 08 RMSA
5106019	FR+L BIT 1/8 5 08 SAC
5106010	FR+L BIT 1/8 5 012 RMSA
5106022	FR+L BIT 1/8 5 012 SAC
5106002	FR+L BIT 1/8 20 02 RMSA
5106014	FR+L BIT 1/8 20 02 SAC
5106005	FR+L BIT 1/8 20 04 RMSA
5106017	FR+L BIT 1/8 20 04 SAC
5106008	FR+L BIT 1/8 20 08 RMSA
5106020	FR+L BIT 1/8 20 08 SAC
5106011	FR+L BIT 1/8 20 012 RMSA
5106023	FR+L BIT 1/8 20 012 SAC
5106003	FR+L BIT 1/8 50 02 RMSA
5106015	FR+L BIT 1/8 50 02 SAC
5106006	FR+L BIT 1/8 50 04 RMSA
5106018	FR+L BIT 1/8 50 04 SAC
5106009	FR+L BIT 1/8 50 08 RMSA
5106021	FR+L BIT 1/8 50 08 SAC
5106012	FR+L BIT 1/8 50 012 RMSA
5106024	FR+L BIT 1/8 50 012 SAC
5206001	FR+L BIT 1/4 5 02 RMSA
5206013	FR+L BIT 1/4 5 02 SAC
5206004	FR+L BIT 1/4 5 04 RMSA
5206016	FR+L BIT 1/4 5 04 SAC
5206007	FR+L BIT 1/4 5 08 RMSA
5206019	FR+L BIT 1/4 5 08 SAC
5206010	FR+L BIT 1/4 5 012 RMSA
5206022	FR+L BIT 1/4 5 012 SAC
5206002	FR+L BIT 1/4 20 02 RMSA
5206014	FR+L BIT 1/4 20 02 SAC
5206005	FR+L BIT 1/4 20 04 RMSA
5206017	FR+L BIT 1/4 20 04 SAC
5206008	FR+L BIT 1/4 20 08 RMSA
5206020	FR+L BIT 1/4 20 08 SAC
5206011	FR+L BIT 1/4 20 012 RMSA
5206023	FR+L BIT 1/4 20 012 SAC
5206003	FR+L BIT 1/4 50 02 RMSA
5206015	FR+L BIT 1/4 50 02 SAC
5206006	FR+L BIT 1/4 50 04 RMSA
5206018	FR+L BIT 1/4 50 04 SAC
5206009	FR+L BIT 1/4 50 08 RMSA
5206021	FR+L BIT 1/4 50 08 SAC
5206012	FR+L BIT 1/4 50 012 RMSA
5206024	FR+L BIT 1/4 50 012 SAC

Artikkelnr. Benevnelse

FILTER + FINFILTER

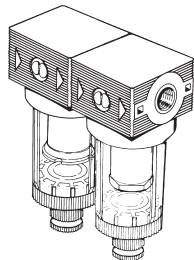

- 5114001 F+D BIT 1/8 5 RMSA
- 5114002 F+D BIT 1/8 5 SAC
- 5214001 F+D BIT 1/4 5 RMSA
- 5214002 F+D BIT 1/4 5 SAC

FILTER + SMØREAPPARAT

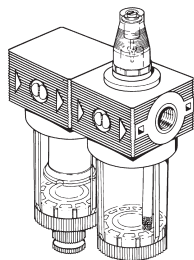

- 5113001 F+L BIT 1/8 5 RMSA
- 5113004 F+L BIT 1/8 5 SAC
- 5113002 F+L BIT 1/8 20 RMSA
- 5113005 F+L BIT 1/8 20 SAC
- 5113003 F+L BIT 1/8 50 RMSA
- 5113006 F+L BIT 1/8 50 SAC
- 5213001 F+L BIT 1/4 5 RMSA
- 5213004 F+L BIT 1/4 5 SAC
- 5213002 F+L BIT 1/4 20 RMSA
- 5213005 F+L BIT 1/4 20 SAC
- 5213003 F+L BIT 1/4 50 RMSA
- 5213006 F+L BIT 1/4 50 SAC

Artikkelnr. Benevnelse

FILTER + REGULATOR + SMØREAPPARAT

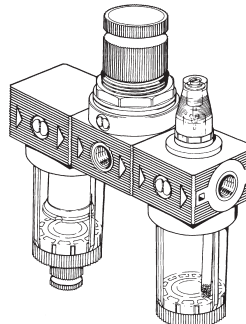

- 5104001 FRL BIT 1/8 5 02 RMSA
- 5104013 FRL BIT 1/8 5 02 SAC
- 5104004 FRL BIT 1/8 5 04 RMSA
- 5104016 FRL BIT 1/8 5 04 SAC
- 5104007 FRL BIT 1/8 5 08 RMSA
- 5104019 FRL BIT 1/8 5 08 SAC
- 5104010 FRL BIT 1/8 5 012 RMSA
- 5104022 FRL BIT 1/8 5 012 SAC
- 5104002 FRL BIT 1/8 20 02 RMSA
- 5104014 FRL BIT 1/8 20 02 SAC
- 5104005 FRL BIT 1/8 20 04 RMSA
- 5104017 FRL BIT 1/8 20 04 SAC
- 5104008 FRL BIT 1/8 20 08 RMSA
- 5104020 FRL BIT 1/8 20 08 SAC
- 5104011 FRL BIT 1/8 20 012 RMSA
- 5104023 FRL BIT 1/8 20 012 SAC
- 5104003 FRL BIT 1/8 50 02 RMSA
- 5104015 FRL BIT 1/8 50 02 SAC
- 5104006 FRL BIT 1/8 50 04 RMSA
- 5104018 FRL BIT 1/8 50 04 SAC
- 5104009 FRL BIT 1/8 50 08 RMSA
- 5104021 FRL BIT 1/8 50 08 SAC
- 5104012 FRL BIT 1/8 50 012 RMSA
- 5104024 FRL BIT 1/8 50 012 SAC
- 5204001 FRL BIT 1/4 5 02 RMSA
- 5204013 FRL BIT 1/4 5 02 SAC
- 5204004 FRL BIT 1/4 5 04 RMSA
- 5204016 FRL BIT 1/4 5 04 SAC
- 5204007 FRL BIT 1/4 5 08 RMSA
- 5204019 FRL BIT 1/4 5 08 SAC
- 5204010 FRL BIT 1/4 5 012 RMSA
- 5204022 FRL BIT 1/4 5 012 SAC
- 5204002 FRL BIT 1/4 20 02 RMSA
- 5204014 FRL BIT 1/4 20 02 SAC
- 5204005 FRL BIT 1/4 20 04 RMSA
- 5204017 FRL BIT 1/4 20 04 SAC
- 5204008 FRL BIT 1/4 20 08 RMSA
- 5204020 FRL BIT 1/4 20 08 SAC
- 5204011 FRL BIT 1/4 20 012 RMSA
- 5204023 FRL BIT 1/4 20 012 SAC
- 5204003 FRL BIT 1/4 50 02 RMSA
- 5204015 FRL BIT 1/4 50 02 SAC
- 5204006 FRL BIT 1/4 50 04 RMSA
- 5204018 FRL BIT 1/4 50 04 SAC
- 5204009 FRL BIT 1/4 50 08 RMSA
- 5204021 FRL BIT 1/4 50 08 SAC
- 5204012 FRL BIT 1/4 50 012 RMSA
- 5204024 FRL BIT 1/4 50 012 SAC



TILBEHØR

Artikkelnr. Benevnelse

MANOMETER

9700102 M40 1/8 0-12 Manometer
9700101 M40 1/8 0-4 Manometer

MONTERINGSVINKEL

9200701 SF 100-BIT-ND 1/4 Monteringsvinkel

MONTERINGS SETT FOR FR + L

9170201 PAB BIT Monterings sett

VEGGMONTERINGS SETT

9170301 SFB BIT Veggmonterings sett

LUFTUTTAK

9100401 PA BIT Luftuttak

NØKKEL FOR DEMONTERING AV SEGLASS

9220701 CS CVL 100-200-300-400-BIT Verktøy

NØKKEL FOR DEMONTERING AV JUSTERINGSENHET

9170401 CS CS BIT Verktøy

NØKKEL FOR DEMONTERING AV BUNNVENTIL

9170501 CS OTR BIT Verktøy

NØKKEL FOR DEMONTERING AV BEHOLDER

9170601 CS TF-TL BIT Verktøy

RESERVEDELER

Artikkelnr. Benevnelse

JUSTERINGSENHET MR + FR

9250805 CS BIT 02 Justeringsenhet
9250806 CS BIT 04 Justeringsenhet
9250807 CS BIT 08 Justeringsenhet
9250808 CS BIT 012 Justeringsenhet

JUSTERINGSENHET MR

9250817 CS BIT-FC 02 Justeringsenhet
9250818 CS BIT-FC 04 Justeringsenhet

JUSTERINGSENHET (MRA)

9250809 CSA BIT 02 Justeringsenhet
9250814 CSA BIT 04 Justeringsenhet
9250815 CSA BIT 08 Justeringsenhet
9250816 CSA BIT 012 Justeringsenhet

BUNNVENTIL

9250705 OTMR-OTMRA BIT Bunnventil
9250706 OTMR MRA SR BIT Bunnventil

FILTERBEHOLDER

9255001 TF BIT Filterbeholder
9255101 TF BIT SAC Filterbeholder

AUTODREN

9000803 SAC 100-200-BIT Autodren

BEHOLDER FOR SMØREAPPARAT

9251402 TL BIT Smøreapparat beholder

FILTERELEMENT

9251708 FP BIT 5 Filterelement
9251709 FP BIT 20 Filterelement
9251710 FP BIT 50 Filterelement

FINFILTERELEMENT

9251712 FP D BIT Finfilterelement

VENTIL FOR FR

9250905 OTFR BIT 5 Ventil FR
9250906 OTFR BIT 20 Ventil FR
9250907 OTFR BIT 50 Ventil FR

SEGLASS FOR SMØREAPPARAT

9251301 CVL 1/4 Seglass, smøreapparat
9251302 CVL 100-200-300-400-BIT Seglass

FJÆR FOR FR + MR

9250610 MO BIT 02 Fjær
9250611 MO BIT 04 Fjær
9250612 MO BIT 08 Fjær
9250613 MO BIT 012 Fjær

New deal



Artikkelnr. Benevnelse

FILTER

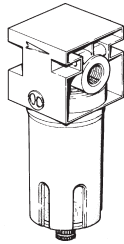

1221005	FIL 1/4 4 RMSA TMV Filter
1221013	FIL 1/4 4 SAC TMV Filter
1221006	FIL 1/4 20 RMSA TMV Filter
1221014	FIL 1/4 20 SAC TMV Filter
1221008	FIL 1/4 50 RMSA TMV Filter
1221016	FIL 1/4 50 SAC TMV Filter
1321005	FIL 3/8 4 RMSA TMV Filter
1321013	FIL 3/8 4 SAC TMV Filter
1321006	FIL 3/8 20 RMSA TMV Filter
1321014	FIL 3/8 20 SAC TMV Filter
1321008	FIL 3/8 50 RMSA TMV Filter
1321016	FIL 3/8 50 SAC TMV Filter
1421005	FIL 1/2 4 RMSA TMV Filter
1421013	FIL 1/2 4 SAC TMV Filter
1421006	FIL 1/2 20 RMSA TMV Filter
1421014	FIL 1/2 20 SAC TMV Filter
1421008	FIL 1/2 50 RMSA TMV Filter
1421016	FIL 1/2 50 SAC TMV Filter
1521005	FIL 3/4 4 RMSA TMV Filter
1521009	FIL 3/4 4 RA TMV Filter
1521006	FIL 3/4 20 RSA TMV Filter
1521010	FIL 3/4 20 RA TMV Filter
1521008	FIL 3/4 50 RMSA TMV Filter
1521012	FIL 3/4 50 RA TMV Filter
1621005	FIL 1" 4 RMSA TMV Filter
1621009	FIL 1" 4 RA TMV Filter
1621006	FIL 1" 20 RSA TMV Filter
1621010	FIL 1" 20 RA TMV Filter
1621008	FIL 1" 50 RSA TMV Filter
1621012	FIL 1" 50 RA TMV Filter

REGULATOR

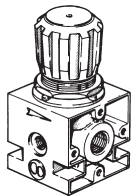

1202001	REG 1/4 04 Regulator
1202002	REG 1/4 08 Regulator
1202003	REG 1/4 012 Regulator
1202004	REG 1/4 02 Regulator
1302001	REG 3/8 04 Regulator
1302002	REG 3/8 08 Regulator
1302003	REG 3/8 012 Regulator
1402001	REG 1/2 04 Regulator
1402002	REG 1/2 08 Regulator
1402003	REG 1/2 012 Regulator
1502001	REG 3/4 04 Regulator
1502002	REG 3/4 08 Regulator
1502003	REG 3/4 012 Regulator
1602001	REG 1" 04 Regulator
1602002	REG 1" 08 Regulator
1602003	REG 1" 012 Regulator

Artikkelnr. Benevnelse

PILOTREGULATOR

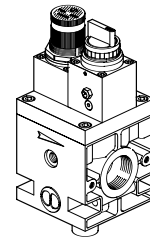

1618001	REGP 1" 02 Regulator
1618002	REGP 1" 04 Regulator
1618003	REGP 1" 08 Regulator
1618004	REGP 1" 012 Regulator
1619001	REGP 1" 00 Regulator
1518001	REGP 3/4 02 Regulator
1518002	REGP 3/4 04 Regulator
1518003	REGP 3/4 08 Regulator
1518004	REGP 3/4 012 Regulator
1519001	REGP 3/4 00 Regulator

PILOTSTYRT REGULATOR

1302004	RP 3/8 Pilotstyrt reg.
1402004	RP 1/2 Pilotstyrt reg.

REGULATOR NEWTRONIC

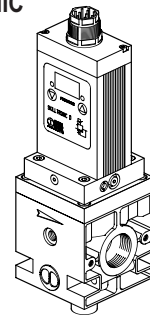

1620001	NEWTRONIC 1 A
1620002	NEWTRONIC 1 D
1520001	NEWTRONIC 3/4 A
1520002	NEWTRONIC 3/4 D

SMØREAPPARAT

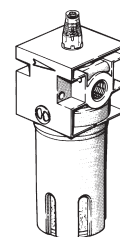

1223001	LUB 1/4 N Smøreapparat
1323001	LUB 3/8 N Smøreapparat
1423001	LUB 1/2 N Smøreapparat
1523001	LUB 3/4 N Smøreapparat
1623001	LUB 1" N Smøreapparat

Artikkelnr. Benevnelse

PILOTREGULATOR + V3V

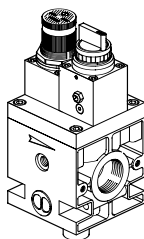

1516001	RV3V 3/4 02 Manuell
1516002	RV3V 3/4 04 Manuell
1516003	RV3V 3/4 08 Manuell
1516004	RV3V 3/4 012 Manuell
1516101	RV3V 3/4 02 Nøkkelman.
1516102	RV3V 3/4 04 Nøkkelman.
1516103	RV3V 3/4 08 Nøkkelman.
1516104	RV3V 3/4 012 Nøkkelman.
1517001	RV3V 3/4 02 Elstyr
1517002	RV3V 3/4 04 Elstyr
1517003	RV3V 3/4 08 Elstyr
1616001	RV3V 1" 02 Manuell
1616002	RV3V 1" 04 Manuell
1616003	RV3V 1" 08 Manuell
1616004	RV3V 1" 012 Manuell
1616101	RV3V 1" 02 Nøkkelman.
1616102	RV3V 1" 04 Nøkkelman.
1616103	RV3V 1" 08 Nøkkelman.
1616104	RV3V 1" 012 Nøkkelman.
1617001	RV3V 1" 02 Elstyr
1617002	RV3V 1" 04 Elstyr
1617003	RV3V 1" 08 Elstyr

FINFILTER

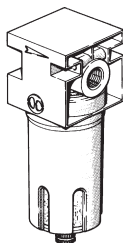

1322002	DEP 3/8 RMSA TMV Finfilter
1322003	DEP 3/8 RA TMV Finfilter
1422002	DEP 1/2 RMSA TMV Finfilter
1422003	DEP 1/2 RA TMV Finfilter

FILTERREGULATOR

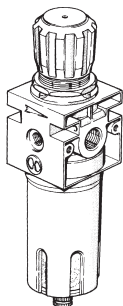

1225029	FR 1/4 4 08 RMSA TMV Filterreg.
1225053	FR 1/4 4 012 RMSA TMV Filterreg.
1225509	FR 1/4 4 08 SAC TMV Filterreg.
1225513	FR 1/4 4 012 SAC TMV Filterreg.
1225030	FR 1/4 20 08 RMSA TMV Filterreg.
1225510	FR 1/4 20 08 SAC TMV Filterreg.
1225054	FR 1/4 20 012 RMSA TMV Filterreg.
1225514	FR 1/4 20 012 SAC TMV Filterreg.
1225032	FR 1/4 50 08 RMSA TMV Filterreg.
1225511	FR 1/4 50 08 SAC TMV Filterreg.

Artikkelnr. Benevnelse

FILTERREGULATOR

1225056	FR 1/4 50 012 RMSA TMV Filterreg.
1225516	FR 1/4 50 012 SAC TMV Filterreg.
1325029	FR 3/8 4 08 RMSA TMV Filterreg.
1325509	FR 3/8 4 08 SAC TMV Filterreg.
1325053	FR 3/8 4 012 RMSA TMV Filterreg.
1325513	FR 3/8 4 012 SAC TMV Filterreg.
1325030	FR 3/8 20 08 RMSA TMV Filterreg.
1325510	FR 3/8 20 08 SAC TMV Filterreg.
1325054	FR 3/8 20 012 RMSA TMV Filterreg.
1325514	FR 3/8 20 012 SAC TMV Filterreg.
1325032	FR 3/8 50 08 RMSA TMV Filterreg.
1325512	FR 3/8 50 08 SAC TMV Filterreg.
1325056	FR 3/8 50 012 RMSA TMV Filterreg.
1325516	FR 3/8 50 012 SAC TMV Filterreg.
1425029	FR 1/2 20 04 RMSA TMV Filterreg.
1425509	FR 1/2 4 08 SAC TMV Filterreg.
1425053	FR 1/2 4 012 RMSA TMV Filterreg.
1425513	FR 1/2 4 012 SAC TMV Filterreg.
1425030	FR 1/2 20 08 RMSA TMV Filterreg.
1425510	FR 1/2 20 08 SAC TMV Filterreg.
1425054	FR 1/2 20 012 RMSA TMV Filterreg.
1425514	FR 1/2 20 012 SAC TMV Filterreg.
1425032	FR 1/2 50 08 RMSA TMV Filterreg.
1425512	FR 1/2 50 08 SAC TMV Filterreg.
1425056	FR 1/2 50 012 RMSA TMV Filterreg.
1425516	FR 1/2 50 012 SAC TMV Filterreg.

3-VEIS VENTIL

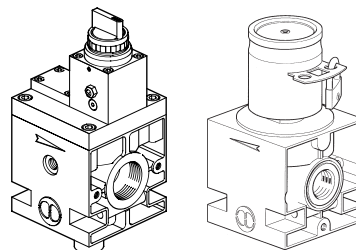

1270001	V3V 1/4 3-veis ventil
1370001	V3V 3/8 3-veis ventil
1470001	V3V 1/2 3-veis ventil
1574001	V3V 3/4 3-veis manuell
1574101	V3V 3/4 3-veis nøkkelman.
1575001	V3V 3/4 CNOMO Elstyr
1674001	V3V 1" 3-veis manuell
1674101	V3V 1" 3-veis nøkkelman.
1675001	V3V 1" CNOMO Elstyr
1676001	V3V 1" Pneumatisk

AUTOMATISK DRENERING

4589003	S.C.A.L. Automatisk drenering
---------	-------------------------------

FILTER + FINFILTER

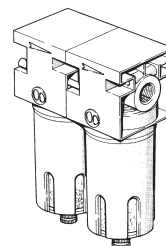

1327004	F+D 3/8 4 RMSA-RMSA TMV
1327007	F+D 3/8 4 RA-RA TMV
1327104	F+D 3/8 4 SAC-RMSA TMV
1427004	F+D 1/2 4 RMSA-RMSA TMV
1427007	F+D 1/2 4 RA-RA TMV
1427104	F+D 1/2 4 SAC-RMSA TMV

Artikkelnr. Benevnelse

FILTER + SMØREAPPARAT

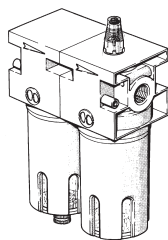

1233005	F+L 1/4 4 RMSA N TMV
1233213	F+L 1/4 4 SAC N TMV
1233006	F+L 1/4 20 RMSA N TMV
1233214	F+L 1/4 20 SAC N TMV
1233008	F+L 1/4 50 RMSA N TMV
1233216	F+L 1/4 50 SAC N TMV
1333005	F+L 3/8 4 RMSA N TMV
1333009	F+L 3/8 4 RA N TMV
1333213	F+L 3/8 4 SAC N TMV
1333006	F+L 3/8 20 RMSA N TMV
1333010	F+L 3/8 20 RA N TMV
1333214	F+L 3/8 20 SAC N TMV
1333008	F+L 3/8 50 RMSA N TMV
1333012	F+L 3/8 50 RA N TMV
1333216	F+L 3/8 50 SAC N TMV
1433005	F+L 1/2 4 RMSA N TMV
1433009	F+L 1/2 4 RA N TMV
1433213	F+L 1/2 4 SAC N TMV
1433006	F+L 1/2 20 RMSA N TMV
1433010	F+L 1/2 20 RA N TMV
1433214	F+L 1/2 20 SAC N TMV
1433008	F+L 1/2 50 RMSA N TMV
1433012	F+L 1/2 50 RA N TMV
1433216	F+L 1/2 50 SAC N TMV
1533005	F+L 3/4 4 RMSA N TMV
1533009	F+L 3/4 4 RA N TMV
1533006	F+L 3/4 20 RMSA N TMV
1533010	F+L 3/4 20 RA N TMV
1533008	F+L 3/4 50 RMSA N TMV
1533012	F+L 3/4 50 RA N TMV
1633005	F+L 1" 4 RMSA N TMV
1633009	F+L 1" 4 RA N TMV
1633006	F+L 1" 20 RMSA N TMV
1633010	F+L 1" 20 RA N TMV
1633008	F+L 1" 50 RMSA N TMV
1633012	F+L 1" 50 RA N TMV

FILTER + REGULATOR + SMØREAPPARAT

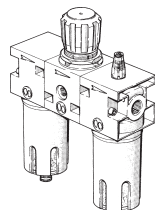

1224029	FRL 1/4 4 08 RMSA N TMV
1224409	FRL 1/4 4 08 SAC N TMV
1224030	FRL 1/4 20 08 RMSA N TMV
1224410	FRL 1/4 20 08 SAC N TMV
1224032	FRL 1/4 50 08 RMSA N TMV
1224412	FRL 1/4 50 08 SAC N TMV
1224053	FRL 1/4 4 012 RMSA N TMV
1224413	FRL 1/4 4 012 SAC N TMV
1224054	FRL 1/4 20 012 RMSA N TMV

Artikkelnr. Benevnelse

1224414	FRL 1/4 20 012 SAC N TMV
1224056	FRL 1/4 50 012 RMSA N TMV
1224416	FRL 1/4 50 012 SAC N TMV
1324029	FRL 3/8 4 08 RMSA N TMV
1324033	FRL 3/8 4 08 RA N TMV
1324409	FRL 3/8 4 08 SAC N TMV
1324030	FRL 3/8 20 08 RMSA N TMV
1324034	FRL 3/8 20 08 RA N TMV
1324410	FRL 3/8 20 08 SAC N TMV
1324032	FRL 3/8 50 08 RMSA N TMV
1324036	FRL 3/8 50 08 RA N TMV
1324412	FRL 3/8 50 08 SAC N TMV
1324053	FRL 3/8 4 RMSA 012 N TMV
1324057	FRL 3/8 4 012 RA N TMV
1324413	FRL 3/8 4 012 SAC N TMV
1324054	FRL 3/8 20 RMSA 012 N TMV
1324058	FRL 3/8 20 012 RA N TMV
1324414	FRL 3/8 20 012 SAC N TMV
1324056	FRL 3/8 50 RMSA 012 N TMV
1324060	FRL 3/8 50 012 RA N TMV
1324416	FRL 3/8 50 012 SAC N TMV
1424029	FRL 1/2 4 08 RMSA N TMV
1424033	FRL 1/2 4 08 RA N TMV
1424409	FRL 1/2 4 08 SAC N TMV
1424030	FRL 1/2 20 08 RMSA N TMV
1424034	FRL 1/2 20 08 RA N TMV
1424410	FRL 1/2 20 08 SAC N TMV
1424032	FRL 1/2 50 08 RMSA N TMV
1424036	FRL 1/2 50 08 RA N TMV
1424412	FRL 1/2 50 08 SAC N TMV
1424053	FRL 1/2 4 012 RMSA N TMV
1424057	FRL 1/2 4 012 RA N TMV
1424413	FRL 1/2 4 012 SAC N TMV
1424054	FRL 1/2 20 012 RMSA N TMV
1424058	FRL 1/2 20 012 RA N TMV
1424414	FRL 1/2 20 012 SAC N TMV
1424056	FRL 1/2 50 012 RMSA N TMV
1424060	FRL 1/2 50 012 RA N TMV
1424416	FRL 1/2 50 012 SAC N TMV
1524017	FRL 3/4 4 08 RMSA N TMV
1524021	FRL 3/4 4 08 RA N TMV
1524018	FRL 3/4 20 08 RMSA N TMV
1524022	FRL 3/4 20 08 RA N TMV
1524020	FRL 3/4 50 08 RMSA N TMV
1524024	FRL 3/4 50 08 RA N TMV
1524029	FRL 3/4 4 012 RMSA N TMV
1524033	FRL 3/4 4 012 RA N TMV
1524030	FRL 3/4 20 012 RMSA N TMV
1524034	FRL 3/4 20 012 RA N TMV
1524032	FRL 3/4 50 012 RMSA N TMV
1524036	FRL 3/4 50 012 RA N TMV
1624017	FRL 1" 4 08 RMSA N TMV
1624021	FRL 1" 4 08 RA N TMV
1624018	FRL 1" 20 08 RMSA N TMV
1624022	FRL 1" 20 08 RA N TMV
1624020	FRL 1" 50 08 RMSA N TMV
1624024	FRL 1" 50 08 RA N TMV
1624029	FRL 1" 4 012 RMSA N TMV
1624033	FRL 1" 4 012 RA N TMV
1624030	FRL 1" 20 012 RMSA N TMV
1624034	FRL 1" 20 012 RA N TMV
1624032	FRL 1" 50 012 RMSA N TMV
1624036	FRL 1" 50 012 RA N TMV

Artikkelnr. Benevnelse

FILTERREGULATOR + SMØREAPPARAT

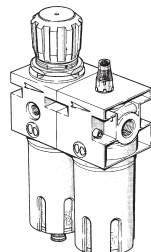

1226029	FR+L 1/4 4 08 RMSA N TMV
1226409	FR+L 1/4 4 08 SAC N TMV
1226053	FR+L 1/4 4 012 RMSA N TMV
1226413	FR+L 1/4 4 012 SAC N TMV
1226030	FR+L 1/4 20 08 RMSA N TMV
1226410	FR+L 1/4 20 08 SAC N TMV
1226054	FR+L 1/4 20 012 RMSA N TMV
1226414	FR+L 1/4 20 012 SAC N TMV
1226032	FR+L 1/4 50 08 RMSA N TMV
1226412	FR+L 1/4 50 08 SAC N TMV
1226056	FR+L 1/4 50 012 RMSA N TMV
1226416	FR+L 1/4 50 012 SAC N TMV
1326029	FR+L 3/8 4 08 RMSA N TMV
1326409	FR+L 3/8 4 08 SAC N TMV
1326053	FR+L 3/8 4 012 RMSA N TMV
1326413	FR+L 3/8 4 012 SAC N TMV
1326030	FR+L 3/8 20 08 RMSA N TMV
1326034	FR+L 3/8 20 08 RA N TMV
1326410	FR+L 3/8 20 08 SAC N TMV
1326054	FR+L 3/8 20 012 RMSA N TMV
1326058	FR+L 3/8 20 RA 012 N TMV
1326414	FR+L 3/8 20 012 SAC N TMV
1326032	FR+L 3/8 50 08 RMSA N TMV
1326412	FR+L 3/8 50 08 SAC N TMV
1326056	FR+L 3/8 50 012 RMSA N TMV
1326416	FR+L 3/8 50 012 SAC N TMV
1426029	FR+L 1/2 4 08 RMSA N TMV
1426409	FR+L 1/2 4 08 SAC N TMV
1426053	FR+L 1/2 4 012 RMSA N TMV
1426413	FR+L 1/2 4 012 SAC N TMV
1426030	FR+L 1/2 20 08 RMSA N TMV
1426034	FR+L 1/2 20 08 RA N TMV
1426410	FR+L 1/2 20 08 SAC N TMV
1426054	FR+L 1/2 20 012 RMSA N TMV
1426058	FR+L 1/2 20 012 RA N TMV
1426414	FR+L 1/2 20 012 SAC N TMV
1426032	FR+L 1/2 50 08 RMSA N TMV
1426412	FR+L 1/2 50 08 SAC N TMV
1426056	FR+L 1/2 50 012 RMSA N TMV
1426416	FR+L 1/2 50 012 SAC N TMV

Artikkelnr. Benevnelse

V3V + FILTER + REGULATOR + SMØREAPPARAT

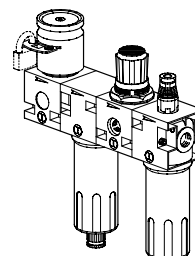

1273029	VFRL 1/4 4 08 RMSA N TMV
1273409	VFRL 1/4 4 08 SAC N TMV
1273053	VFRL 1/4 4 012 RMSA N TMV
1273413	VFRL 1/4 4 012 SAC N TMV
1273030	VFRL 1/4 20 08 RMSA N TMV
1273410	VFRL 1/4 20 08 SAC N TMV
1273054	VFRL 1/4 20 012 RMSA N TMV
1273414	VFRL 1/4 20 012 SAC N TMV
1273032	VFRL 1/4 50 08 RMSA N TMV
1273412	VFRL 1/4 50 08 SAC N TMV
1273056	VFRL 1/4 50 012 RMSA N TMV
1273416	VFRL 1/4 50 012 SAC N TMV
1373029	VFRL 3/8 4 08 RMSA N TMV
1373033	VFRL 3/8 4 08 RA N TMV
1373409	VFRL 3/8 4 08 SAC N TMV
1373053	VFRL 3/8 4 012 RMSA N TMV
1373057	VFRL 3/8 4 012 RA N TMV
1373413	VFRL 3/8 4 012 SAC N TMV
1373030	VFRL 3/8 20 08 RMSA N TMV
1373034	VFRL 3/8 20 08 RA N TMV
1373410	VFRL 3/8 20 08 SAC N TMV
1373054	VFRL 3/8 20 012 RMSA N TMV
1373058	VFRL 3/8 20 012 RA N TMV
1373414	VFRL 3/8 20 012 SAC N TMV
1373032	VFRL 3/8 50 08 RMSA N TMV
1373036	VFRL 3/8 50 08 RA N TMV
1373412	VFRL 3/8 50 08 SAC N TMV
1373056	VFRL 3/8 50 012 RMSA N TMV
1373060	VFRL 3/8 50 012 RA N TMV
1373416	VFRL 3/8 50 012 SAC N TMV
1473029	VFRL 1/2 4 08 RMSA N TMV
1473033	VFRL 1/2 4 08 RA N TMV
1473409	VFRL 1/2 4 08 SAC N TMV
1473053	VFRL 1/2 4 012 RMSA N TMV
1473057	VFRL 1/2 4 012 RA N TMV
1473413	VFRL 1/2 4 012 SAC N TMV
1473030	VFRL 1/2 20 08 RMSA N TMV
1473034	VFRL 1/2 20 08 RA N TMV
1473410	VFRL 1/2 20 08 SAC N TMV
1473054	VFRL 1/2 20 012 RMSA N TMV
1473058	VFRL 1/2 20 012 RA N TMV
1473414	VFRL 1/2 20 012 SAC N TMV
1473032	VFRL 1/2 50 08 RMSA N TMV
1473036	VFRL 1/2 50 08 RA N TMV
1473412	VFRL 1/2 50 08 SAC N TMV
1473056	VFRL 1/2 50 012 RMSA N TMV
1473060	VFRL 1/2 50 012 RA N TMV
1473416	VFRL 1/2 50 012 SAC N TMV

Artikkelnr. Benevnelse

**V3V
+ FILTERREGULATOR
+ SMØREAPPARAT**

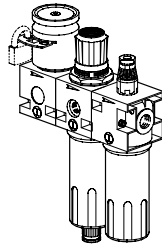

1272029	VFR+L 1/4 4 08 RMSA N TMV
1272509	VFR+L 1/4 4 08 SAC N TMV
1272053	VFR+L 1/4 4 012 RMSA N TMV
1272513	VFR+L 1/4 4 012 SAC N TMV
1272030	VFR+L 1/4 20 08 RMSA N TMV
1272510	VFR+L 1/4 20 08 SAC N TMV
1272054	VFR+L 1/4 20 012 RMSA N TMV
1272514	VFR+L 1/4 20 012 SAC N TMV
1272032	VFR+L 1/4 50 08 RMSA N TMV
1272512	VFR+L 1/4 50 08 SAC N TMV
1272056	VFR+L 1/4 50 012 RMSA N TMV
1272516	VFR+L 1/4 50 012 SAC N TMV
1372029	VFR+L 3/8 4 08 RMSA N TMV
1372509	VFR+L 3/8 4 08 SAC N TMV
1372053	VFR+L 3/8 4 012 RMSA N TMV
1372513	VFR+L 3/8 4 012 SAC N TMV
1372030	VFR+L 3/8 20 08 RMSA N TMV
1272034	VFR+L 3/8 50 08 RA N TMV
1372510	VFR+L 3/8 20 08 SAC N TMV
1372054	VFR+L 3/8 20 012 RMSA N TMV
1372060	VFR+L 3/8 20 012 RA N TMV
1372514	VFR+L 3/8 20 012 SAC N TMV
1372032	VFR+L 3/8 50 08 RMSA N TMV
1372512	VFR+L 3/8 50 08 SAC N TMV
1372056	VFR+L 3/8 50 012 RMSA N TMV
1372516	VFR+L 3/8 50 012 SAC N TMV
1472029	VFR+L 1/2 4 08 RMSA N TMV
1472509	VFR+L 1/2 4 08 SAC N TMV
1472053	VFR+L 1/2 4 012 RMSA N TMV
1472513	VFR+L 1/2 4 012 SAC N TMV
1472030	VFR+L 1/2 20 08 RMSA N TMV
1472034	VFR+L 1/2 50 08 RA N TMV
1472510	VFR+L 1/2 20 08 SAC N TMV
1472054	VFR+L 1/2 20 012 RMSA N TMV
1472060	VFR+L 1/2 20 012 RA N TMV
1472514	VFR+L 1/2 20 012 SAC N TMV
1472032	VFR+L 1/2 50 08 RMSA N TMV
1472512	VFR+L 1/2 50 08 SAC N TMV
1472056	VFR+L 1/2 50 012 RMSA N TMV
1472516	VFR+L 1/2 50 012 SAC N TMV

Artikkelnr. Benevnelse

FRPL 3/4"; 1"

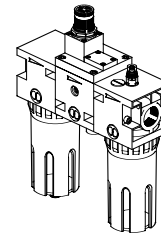

1528007	FRPL 3/4 4 08 RMSA
1528008	FRPL 3/4 20 08 RMSA
1528009	FRPL 3/4 50 08 RMSA
1528010	FRPL 3/4 4 012 RMSA
1528011	FRPL 3/4 20 012 RMSA
1528012	FRPL 3/4 50 012 RMSA
1528019	FRPL 3/4 4 08 RA
1528020	FRPL 3/4 20 08 RA
1528021	FRPL 3/4 50 08 RA
1528022	FRPL 3/4 4 012 RA
1528023	FRPL 3/4 20 012 RA
1528024	FRPL 3/4 50 012 RA
1628007	FRPL 1" 4 08 RMSA
1628008	FRPL 1" 20 08 RMSA
1628009	FRPL 1" 50 08 RA
1628010	FRPL 1" 4 012 RMSA
1628011	FRPL 1" 20 012 RMSA
1628012	FRPL 1" 50 012 RMSA
1628019	FRPL 1" 4 08 RA
1628020	FRPL 1" 20 08 RA
1628021	FRPL 1" 50 08 RA
1628022	FRPL 1" 4 012 RA
1628023	FRPL 1" 20 012 RA
1628024	FRPL 1" 50 012 RA

FRPVL 3/4"; 1"

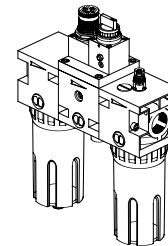

1529007	FRPVL 3/4 4 08 RMSA
1529008	FRPVL 3/4 20 08 RMSA
1529009	FRPVL 3/4 50 08 RMSA
1529010	FRPVL 3/4 4 012 RMSA
1529011	FRPVL 3/4 20 012 RMSA
1529012	FRPVL 3/4 50 012 RMSA
1529019	FRPVL 3/4 4 08 RA
1529020	FRPVL 3/4 20 08 RA
1529021	FRPVL 3/4 50 08 RA
1529022	FRPVL 3/4 4 012 RA
1529023	FRPVL 3/4 20 012 RA
1529024	FRPVL 3/4 50 012 RA
1629007	FRPVL 1" 4 08 RMSA
1629008	FRPVL 1" 20 08 RMSA
1629009	FRPVL 1" 50 08 RMSA
1629010	FRPVL 1" 4 012 RMSA
1629011	FRPVL 1" 20 012 RMSA
1629012	FRPVL 1" 50 012 RMSA
1629019	FRPVL 1" 4 08 RA
1629020	FRPVL 1" 20 08 RA
1629021	FRPVL 1" 50 08 RA
1629022	FRPVL 1" 4 012 RA
1629023	FRPVL 1" 20 012 RA
1629024	FRPVL 1" 50 012 RA



TILBEHØR

RESERVEDELER

Artikkelnr. Benevnelse

MONTERINGSVINKEL

9400701 SF 100-BIT-ND 1/4 Monteringsvinkel
9200701 SF 200-ND 3/8-1/2 Monteringsvinkel

MANOMETER

90311160 M40 1/8 0-12 Manometer
90311115 M40 1/8 0-4 Manometer
90312160 M50 1/8 0-12 Manometer
90313160 M63 1/8 0-12 Manometer

MONTERINGSSKRUER

9200901 F+L 1/4 T Monteringsskrue
9400901 F+L T 1/2 Monteringsskrue
9600901 F+L T 3/4 Monteringsskrue

MANIFOLD FOR REGULATOR

9200201 SB 1/4 2 POS. ND Manifold
9400201 SB 1/2 2 POS. ND Manifold
9600201 SB 3/4 2 POS. ND Manifold
9200301 SB 1/4 3 POS. ND Manifold
9400301 SB 1/2 3 POS. ND Manifold
9600301 SB 3/4 3 POS. ND Manifold

LUFTUTTAK

9200401 PA 1/4 Luftuttak
9400401 PA 1/2 Luftuttak
9600401 PA 3/4 Luftuttak

ADAPTER FOR V3V+FILTER

9201001 Adapter V3V-F 1/4 ND
9401001 Adapter V3V-F 3/8 ND
9401002 Adapter V3V-F 1/2 ND

BLOKK FOR REGULATOR

9200501 BC 1/4 Blokk
9400501 BC 1/2 Blokk
9600501 BC 3/4 Blokk

AVSTANDBLOKK

9200601 DF 1/4 ND Avstandsblokk
9400601 DF 3/8-1/2 ND Avstandsblokk
9600601 DF 3/4 ND Avstandsblokk

NØKKEL FOR DEMONTERING AV BEHOLDER

9601501 CS TMV ND Verktøy

SKRUE FOR MONTERING AV V3V

9250001 CVA 1/4 4x40 Skruer
9250002 CVA 1/4 M4X82 V3V+F+R Skruer
9450001 CVA 1/2 M5x55 Skruer
9450002 CVA 3/8 1/2 M5x60 V3V+R Skruer
9450003 CVA 3/8 1/2 M5x120 V3V+F+R Skruer
9650001 CVA 1" 6x70 Skruer

Artikkelnr. Benevnelse

FILTERELEMMENT

9450102 FP 1/2 20 Filterelement
9450103 FP 1/2 4 Filterelement
9450101 FP 1/2 50 Filterelement
9250102 FP 1/4 20 Filterelement
9250103 FP 1/4 4 Filterelement
9250101 FP 1/4 50 Filterelement
9650103 FP 3/4-1" 4 Filterelement
9650102 FP 3/4 20 Filterelement
9650101 FP 3/4 50 Filterelement

FINFILTERELEMMENT

9450105 FP D 3/8 1/2 Finfilterelement

FILTERBEHOLDER

9450301 TMVF 1/2 RMSA Filterbeholder
9455201 TMVF 1/2 SAC Filterbeholder
9250301 TMF 1/4 RMSA Filterbeholder
9255201 TMVF 1/4 SAC Filterbeholder
9650301 TMV 3/4; 1" RMSA Filterbeholder

MEMBRAN SMØREAPPARAT

9252001 MB 100-ND 1/4 Membran LUB
9352001 MB 200 ND 3/8 1/2 Membran LUB

AUTODREN

9000801 RA ND 3/8;1 Autodren
9000803 SAC 100-200-BIT Autodren

FJÆR FOR REGULATOR OG FR

9250601 MO 02 1/4 Fjær
9250602 MO 04 1/4 Fjær
9250603 MO 08 1/4 Fjær
9250604 MO 012 1/4 Fjær
9450601 MO 04 1/2 Fjær
9450602 MO 08 1/2 Fjær
9450603 MO 1/2 012 Fjær
9650601 MO 04 3/4 Fjær
9650602 MO 08 3/4 Fjær
9650603 MO 3/4-1 012 Fjær

BEHOLDER FOR SMØREAPPARAT

9251201 TMVL 1/4 Smøreapparat beholder
9451201 TMVL 1/2 Smøreapparat beholder
9651201 TMVL 3/4; 1" Smøreapparat beholder



Artikkelnr. Benevnelse

SEGLASS FOR SMØREAPPARAT

9251301 CVL 1/4 ND Seglass
9651301 CVL 3/4; 1" ND Seglass

VENTIL FILTERREGULATOR

9250901 OTFR 1/4 ND Ventil FR
9450901 OTFR 1/2 ND Ventil FR

BUNNVENTIL REGULATOR

9250701 OTR 1/4 Bunnventil
9450701 OTR 1/2 Bunnventil
9650701 OTR 3/4 Bunnventil

JUSTERINGSENHET REGULATOR OG FR

9250801 CS 1/4 02 Justeringsenhet
9250802 CS 1/4 04 Justeringsenhet
9250803 CS 1/4 08 Justeringsenhet
9250804 CS 1/4 012 Justeringsenhet
9450801 CS 1/2 04 Justeringsenhet
9450802 CS 1/2 08 Justeringsenhet
9450803 CS 1/2 012 Justeringsenhet
9650801 CS 3/4 04 Justeringsenhet
9650802 CS 3/4 08 Justeringsenhet
9650803 CS 3/4 012 Justeringsenhet

TILBEHØR REGULATOR S1

9601001 Adapter V3V+F 3/4 1" ND
9604402 Monteringsskrue V3V+F+R ND 3/4 1
9640001 Plate fjernstyring ND 3/4-1
9640101 Bindplate V3V ND 3/4-1
9640201 Omvent plate CNOMO ND 3/4-1
9640301 Nøkkelman. V3V 3/4-1
9640401 Spakman. V3V 3/4-1
9640501 Pilotregulator ND 02 3/4-1"
9640502 Pilotregulator ND 04 3/4-1"
9640503 Pilotregulator ND 08 3/4-1"
9640504 Pilotregulator ND 012 3/4-1"

NOTATER

Artikkelnr.	Benevnelse	Forp.
-------------	------------	-------

GE BSP/MM

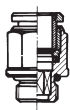

2001B01	R1 3-M3 GE	50
2001B02	R1 3-M5 GE	50
2001A01	R1 3,17-M3 GE	50
2001A02	R1 3,17-M5 GE	50
2001001	R1 4-M5 GE	50
2001002	R1 4-1/8 GE	50
2001003	R1 4-1/4 GE	50
2001004	R1 5-M5 GE	50
2001005	R1 5-1/8 GE	50
2001006	R1 5-1/4 GE	50
2001000	R1 6-M5 GE	50
2001007	R1 6-1/8 GE	50
2001008	R1 6-1/4 GE	50
2001009	R1 8-1/8 GE	50
2001010	R1 8-1/4 GE	50
2001011	R1 8-3/8 GE	50
2001012	R1 10-1/4 GE	50
2001013	R1 10-3/8 GE	50
2001019	R1 12-1/4 GE	25
2001014	R1 12-3/8 GE	25
2001015	R1 12-1/2 GE	25
2001016	R1 14-3/8 GE	25
2001017	R1 14-1/2 GE	25
2001101	R1 6-M12x1,5 GE	50
2001102	R1 8-M12x1,5 GE	50

GE BSP/MM KONISK

2001C13	R1/C 10-1/4 GE	50
2001C14	R1/C 10-3/8 GE	50
2001C15	R1/C 12-3/8 GE	25
2001Z07	R1/Z 6-M12x1 GE	50
2001Z08	R1/Z 6-M12x1,25 GE	50

GAI BSP

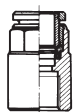

2002001	R2 4-1/8 GAI	50
2002002	R2 4-1/4 GAI	50
2002003	R2 5-1/8 GAI	50
2002004	R2 5-1/4 GAI	50
2002005	R2 6-1/8 GAI	50
2002006	R2 6-1/4 GAI	50
2002007	R2 8-1/8 GAI	50
2002008	R2 8-1/4 GAI	50

G

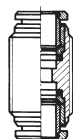

2003001	R3 4 G	50
2003002	R3 5 G	50
2003003	R3 6 G	50
2003004	R3 8 G	50
2003005	R3 10 G	50
2003006	R3 12 G	25
2003007	R3 14 G	20

Artikkelnr.	Benevnelse	Forp.
-------------	------------	-------

W

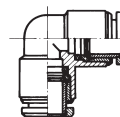

2004001	R4 4 W	50
2004002	R4 5 W	50
2004003	R4 6 W	50
2004004	R4 8 W	50
2004005	R4 10 W	50
2004006	R4 12 W	25
2004007	R4 14 W	20

T

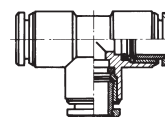

2005001	R5 4 T	50
2005002	R5 5 T	50
2005003	R5 6 T	50
2005004	R5 8 T	50
2005005	R5 10 T	20
2005006	R5 12 T	20
2005007	R5 14 T	10

SPA BSP/MM



2006A01	R6 3.17 M5 SPA	100
2006001	R6 4-M5 SPA	50
2006002	R6 4-1/8 SPA	50
2006003	R6 4-1/4 SPA	50
2006004	R6 5-M5 SPA	50
2006005	R6 5-1/8 SPA	50
2006006	R6 5-1/4 SPA	50
2006000	R6 6-M5 SPA	50
2006007	R6 6-1/8 SPA	50
2006008	R6 6-1/4 SPA	50
2006009	R6 8-1/8 SPA	50
2006010	R6 8-1/4 SPA	50
2006011	R6 8-3/8 SPA	50
2006012	R6 10-1/4 SPA	50
2006013	R6 10-3/8 SPA	50
2006014	R6 12-3/8 SPA	25
2006015	R6 12-1/2 SPA	25
2006016	R6 14-3/8 SPA	25
2006017	R6 14-1/2 SPA	25
2006019	R6 12-1/4 SPA	25
2006101	R6 6-M12x1,5 SPA	50
2006102	R6 8-M12x1,5 SPA	50

Artikkelnr.	Benevnelse	Forp.
-------------	------------	-------

SKJØTERØR



2007001	R7 4 Skjøterør	100
2007002	R7 5 Skjøterør	50
2007003	R7 6 Skjøterør	50
2007004	R7 8 Skjøterør	50
2007005	R7 10 Skjøterør	50
2007006	R7 12 Skjøterør	25
2007007	R7 14 Skjøterør	20

KOR

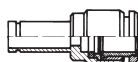

2008001	R8 5-4 KOR	50
2008002	R8 6-4 KOR	50
2008003	R8 6-5 KOR	50
2008004	R8 8-4 KOR	50
2008005	R8 8-5 KOR	50
2008006	R8 8-6 KOR	50
2008007	R8 10-6 KOR	50
2008008	R8 10-8 KOR	50
2008009	R8 12-4 KOR	25
2008010	R8 12-6 KOR	25
2008011	R8 12-8 KOR	25
2008014	R8 14-8 KOR	25
2008015	R8 12-10 KOR	25
2008017	R8 14-10 KOR	25
2008018	R8 14-12 KOR	25

KOR OMVENT

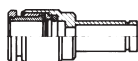

2009001	R8/M 4-6 KOR	50
---------	--------------	----

PLUGG



2010A01	R9 3.17 PLUGG	100
2010001	R9 4 PLUGG	100
2010002	R9 5 PLUGG	50
2010003	R9 6 PLUGG	50
2010004	R9 8 PLUGG	50
2010005	R9 10 PLUGG	50
2010006	R9 12 PLUGG	25
2010007	R9 14 PLUGG	25

SV

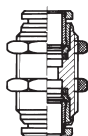

2011001	R10 4 SV	50
2011002	R10 5 SV	50
2011003	R10 6 SV	50
2011004	R10 8 SV	50
2011005	R10 10 SV	25
2011006	R10 12 SV	25
2011007	R10 14 SV	25

Artikkelnr.	Benevnelse	Forp.
-------------	------------	-------

BANJO BSP/MM

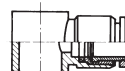

2012A02	R13 3-M5 Enkel banjo	100
2012A01	R13 3.17-M5 Enkel banjo	100
2012002	R13 4-1/8 Enkel banjo	50
2012003	R13 5-M5 Enkel banjo	50
2012004	R13 5-1/8 Enkel banjo	50
2012005	R13 6-1/8 Enkel banjo	50
2012006	R13 6-1/4 Enkel banjo	50
2012007	R13 8-1/8 Enkel banjo	50
2012008	R13 8-1/4 Enkel banjo	50
2012009	R13 8-3/8 Enkel banjo	50
2012010	R13 10-1/4 Enkel banjo	50
2012011	R13 10-3/8 Enkel banjo	50
2012012	R13 12-3/8 Enkel banjo	25
2012013	R13 12-1/4 Enkel banjo	25
2012014	R13 12-1/2 Enkel banjo	20

DOBBEL BANJO BSP/MM

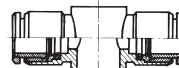

2013002	R14 4-1/8 Dobbelbanjo	50
2013003	R14 5-M5 Dobbelbanjo	50
2013004	R14 5-1/8 Dobbelbanjo	50
2013005	R14 6-1/8 Dobbelbanjo	50
2013006	R14 6-1/4 Dobbelbanjo	50
2013007	R14 8-1/8 Dobbelbanjo	50
2013008	R14 8-1/4 Dobbelbanjo	50
2013009	R14 8-3/8 Dobbelbanjo	25
2013010	R14 10-1/4 Dobbelbanjo	25
2013011	R14 10-3/8 Dobbelbanjo	20
2013012	R14 12-3/8 Dobbelbanjo	25
2013013	R14 12-1/4 Dobbelbanjo	25
2013014	R14 12-1/2 Dobbelbanjo	20

ENKEL SVIVELKUPPLING

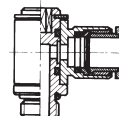

2014101	R15 3-M3 Svivelkupling	100
2014102	R15 3,17-M3 Svivelkupling	100
2014103	R15 3-M5 Svivelkupling	100
2014104	R15 3,17-M5 Svivelkupling	100
2014001	R15 4-M5 Svivelkupling	50
2014002	R15 4-1/8 Svivelkupling	50
2014003	R15 5-M5 Svivelkupling	50
2014004	R15 5-1/8 Svivelkupling	50
2014106	R15 6-M5 Svivelkupling	50
2014005	R15 6-1/8 Svivelkupling	50
2014006	R15 8-1/8 Svivelkupling	50
2014007	R15 6-1/4 Svivelkupling	50
2014008	R15 8-1/4 Svivelkupling	50
2014009	R15 10-1/4 Svivelkupling	50
2014010	R15 12-1/4 Svivelkupling	25
2014011	R15 12-3/8 Svivelkupling	25
2014012	R15 12-1/2 Svivelkupling	20
2014013	R15 8-3/8 Svivelkupling	25
2014014	R15 10-3/8 Svivelkupling	25

Artikkelnr.	Benevnelse	Forp.
-------------	------------	-------

T TEKNOPOLYMER

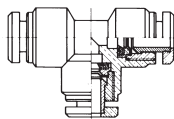

2022001	R22 4 T	50
2022002	R22 5 T	50
2022003	R22 6 T	50
2022004	R22 8 T	50
2022005	R22 10 T	20
2022006	R22 12 T	20

Y TEKNOPOLYMER

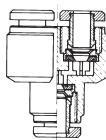

2023001	R23 4 Y	50
2023002	R23 5 Y	50
2023003	R23 6 Y	50
2023004	R23 8 Y	50

Y KOR TEKNOPOLYMER

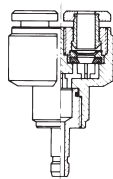

2024001	R24 4 Y, KOR	50
2024003	R24 6 Y, KOR	50

WE BSP/MM

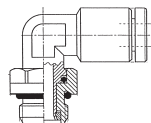

2031001	R31 4-M5 WE	50
2031002	R31 4-1/8 WE	50
2031003	R31 4-1/4 WE	50
2031004	R31 5-M5 WE	50
2031005	R31 5-1/8 WE	50
2031006	R31 5-1/4 WE	50
2031007	R31 6-M5 WE	50
2031008	R31 6-1/8 WE	50
2031009	R31 6-1/4 WE	50
2031010	R31 8-1/8 WE	50
2031011	R31 8-1/4 WE	50
2031012	R31 8-3/8 WE	50
2031013	R31 10-1/4 WE	25
2031014	R31 10-3/8 WE	25
2031015	R31 10-1/2 WE	25
2031016	R31 12-1/4 WE	25
2031017	R31 12-3/8 WE	25
2031018	R31 12-1/2 WE	25
2031019	R31 14-1/2 WE	20

Artikkelnr.	Benevnelse	Forp.
-------------	------------	-------

WE BSP KONISK

2031C13	R31/C 10-1/4 WE	25
2031C14	R31/C 10-3/8 WE	25
2031C15	R31/C 12-3/8 WE	25
2031C16	R31/C 12-1/2 WE	25

TE BSP

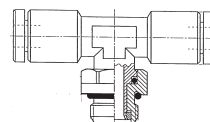

2032002	R32 4-1/8 TE	50
2032005	R32 5-1/8 TE	50
2032008	R32 6-1/8 TE	50
2032009	R32 6-1/4 TE	50
2032010	R32 8-1/8 TE	50
2032011	R32 8-1/4 TE	50
2032012	R32 8-3/8 TE	25
2032013	R32 10-1/4 TE	25
2032014	R32 10-3/8 TE	25
2032017	R32 12-3/8 TE	20
2032018	R32 12-1/2 TE	10
2032019	R32 14-1/2 TE	10

2-PLAN SVIVELKUPPLING

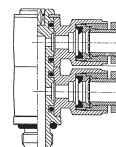

2033001	R33 4-1/8 2-plan svivelkopl.	25
2033002	R33 5-1/8 2-plan svivelkopl.	25
2033003	R33 6-1/8 2-plan svivelkopl.	25
2033004	R33 6-1/4 2-plan svivelkopl.	25
2033005	R33 8-1/8 2-plan svivelkopl.	25
2033006	R33 8-1/4 2-plan svivelkopl.	25



Artikkelnr.	Benevnelse	Forp.
-------------	------------	-------

BOR FOR R25/R26



2025011	Bor R25-R26 4/2	
2025012	Bor R25-R26 5/3	
2025013	Bor R25-R26 6/4	
2025014	Bor R25-R26 8/6	
2025015	Bor R25-R26 10/8	
2025016	Bor R25-R26 12/10	

BOR FOR R27



2027011	Bor R27 4/2 (plast)	
2027013	Bor R27 6/4 (plast)	
2027014	Bor R27 8/6 (plast)	
2027021	Bor R27 4/2 (alum.)	
2027023	Bor R27 6/4 (alum.)	
2027024	Bor R27 8/6 (alum.)	

DEMONTERINGS-VERKTØY



2017001	R40 4-14 Demonteringsverktøy	
---------	------------------------------	--

NØKKELVERKTØY FOR R26

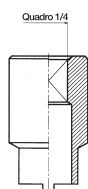

2041001	R41 4/2 Nøkkelverktøy	
2041002	R41 5/3 Nøkkelverktøy	
2041003	R41 6/4 Nøkkelverktøy	
2041004	R41 8/6 Nøkkelverktøy	
2041005	R41 10/8 Nøkkelverktøy	
2041006	R41 12/10 Nøkkelverktøy	
2041007	R41 14/12 Nøkkelverktøy	

GJENGETAPP FOR R25/R26

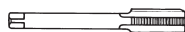

2025021	Gjengetapp R25-R26 4/2	
2025022	Gjengetapp R25-R26 5/3	
2025023	Gjengetapp R25-R26 6/4	
2025024	Gjengetapp R25-R26 8/6	
2025025	Gjengetapp R25-R26 10/8	
2025026	Gjengetapp R25-R26 12/10	

Artikkelnr.	Benevnelse	Forp.
-------------	------------	-------

PATRON MED GJENGE

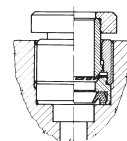

2026001	R26 4/2 Patron, gjenge	50
2026002	R26 5/3 Patron, gjenge	50
2026003	R26 6/4 Patron, gjenge	50
2026004	R26 8/6 Patron, gjenge	50
2026005	R26 10/8 Patron, gjenge	50

PATRON FOR INNPRESSING

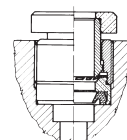

2027001	R27 4/2 Patron	50
2027002	R27 5/3 Patron	50
2027003	R27 6/4 Patron	50
2027004	R27 8/6 Patron	50
2027005	R27 10/8 Patron	50
2027006	R27 12/10 Patron	50

ENKEL BANJO TEKNOPOLYMER



2012102	R28 4-1/8 Enkel banjo	50
2012104	R28 5-1/8 Enkel banjo	50
2012106	R28 6-1/8 Enkel banjo	50
2012107	R28 6-1/4 Enkel banjo	50
2012108	R28 8-1/8 Enkel banjo	50
2012109	R28 8-1/4 Enkel banjo	50
2012110	R28 8-3/8 Enkel banjo	50
2012111	R28 10-1/4 Enkel banjo	50
2012112	R28 10-3/8 Enkel banjo	50
2012113	R28 12-1/4 Enkel banjo	25
2012114	R28 12-3/8 Enkel banjo	25
2012115	R28 12-1/2 Enkel banjo	25

DOBBL BANJO TEKNOPOLYMER

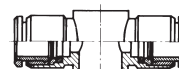

2013102	R29 4-1/8 Dobbelbanjo	50
2013104	R29 5-1/8 Dobbelbanjo	50
2013106	R29 6-1/8 Dobbelbanjo	50
2013107	R29 6-1/4 Dobbelbanjo	50
2013108	R29 8-1/8 Dobbelbanjo	50
2013109	R29 8-1/4 Dobbelbanjo	50
2013110	R29 8-3/8 Dobbelbanjo	25
2013111	R29 10-1/4 Dobbelbanjo	25
2013112	R29 10-3/8 Dobbelbanjo	25
2013113	R29 12-1/4 Dobbelbanjo	25
2013114	R29 12-3/8 Dobbelbanjo	25
2013115	R29 12-1/2 Dobbelbanjo	20

PNEUMATIKK FITTINGS MINIATYRUTFØRELSE RL Fox



Artikkelnr.	Benevnelse	Forp.
-------------	------------	-------

GE BSP/MM

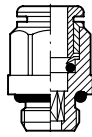

2L01000	RL1 6-M5 GE	50
2L01001	RL1 4-M5 GE	50
2L01002	RL1 4-1/8 GE	50
2L01003	RL1 4-1/4 GE	50
2L01007	RL1 6-1/8 GE	50
2L01008	RL1 6-1/4 GE	50
2L01009	RL1 8-1/8 GE	50
2L01010	RL1 8-1/4 GE	50
2L01011	RL1 8-3/8 GE	50
2L01020	RL1 4-M7 GE	50
2L01021	RL1 6-M7 GE	50
2L01101	RL1 6-M12x1,5 GE	50
2L01102	RL1 8-M12x1,50 GE	50
2L01C02	RL1/C 4-1/8 GE konisk	50
2L01C07	RL1/C 6-1/8 GE konisk	50
2L01C08	RL1/C 6-1/4 GE konisk	50
2L01C09	RL1/C 8-1/8 GE konisk	50
2L01C10	RL1/C 8-1/4 GE konisk	50
2L01C11	RL1/C 8-3/8 GE konisk	50

GAI BSP

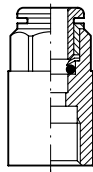

2L02001	RL2 4-1/8 GAI	50
2L02002	RL2 4-1/4 GAI	50
2L02005	RL2 6-1/8 GAI	50
2L02006	RL2 6-1/4 GAI	50
2L02007	RL2 8-1/8 GAI	50
2L02008	RL2 8-1/4 GAI	50

G

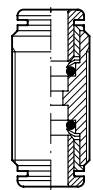

2L03001	RL3 4 G	50
2L03003	RL3 6 G	50
2L03004	RL3 8 G	50

W

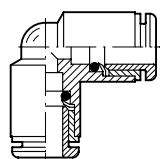

2L04001	RL4 4 W	50
2L04003	RL4 6 W	50
2L04004	RL4 8 W	50

Artikkelnr.	Benevnelse	Forp.
-------------	------------	-------

T

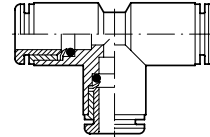

2L05001	RL5 4 T	50
2L05003	RL5 6 T	50
2L05004	RL5 8 T	50

SKJØTERØR

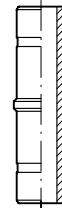

2L07004	RL7 8 Skjøterør	50
---------	-----------------	----

KOR

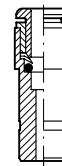

2L08002	RL8 6-4 KOR	50
2L08004	RL8 8-4 KOR	50
2L08006	RL8 8-6 KOR	50

PLUGG

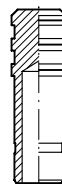

2L10004	RL9 8 PLUGG	50
---------	-------------	----

SV

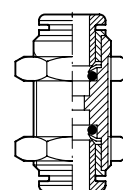

2L11001	RL10 4 SV	50
2L11003	RL10 6 SV	50
2L11004	RL10 8 SV	50



Artikkelnr. Benevnelse Forp.

ENKEL SVIVELKUPPLING

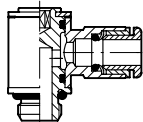

2L14001	RL15 4-M5 Svivelkupling	50
2L14002	RL15 4-1/8 Svivelkupling	50
2L14005	RL15 6-1/8 Svivelkupling	50
2L14006	RL15 8-1/8 Svivelkupling	50
2L14007	RL15 6-1/4 Svivelkupling	50
2L14008	RL15 8-1/4 Svivelkupling	50
2L14106	RL15 6-M5 Svivelkupling	50

DOBDEL SVIVELKUPPLING

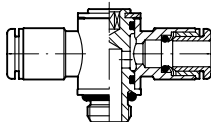

2L15001	RL16 4-M5 Dobbel svivelkupl.	50
2L15002	RL16 4-1/8 Dobbel svivelkupl.	50
2L15005	RL16 6-1/8 Dobbel svivelkupl.	50
2L15006	RL16 8-1/8 Dobbel svivelkupl.	50
2L15007	RL16 6-1/4 Dobbel svivelkupl.	25
2L15008	RL16 8-1/4 Dobbel svivelkupl.	25
2L15106	RL16 6-M5 Dobbel svivelkupl.	50

W TEKNOPOLYMER

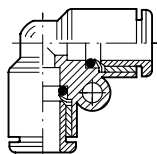

2L21001	RL21 4 W	50
2L21003	RL21 6 W	50
2L21004	RL21 8 W	50

T TEKNOPOLYMER

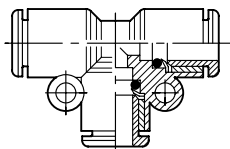

2L22001	RL22 4 T	50
2L22003	RL22 6 T	50
2L22004	RL22 8 T	50

Artikkelnr. Benevnelse Forp.

WE BSP/MM

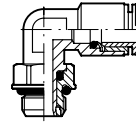

2L31001	RL31 4-M5 WE	50
2L31002	RL31 4-1/8 WE	50
2L31003	RL31 4-1/4 WE	50
2L31007	RL31 6-M5 WE	50
2L31008	RL31 6-1/8 WE	50
2L31009	RL31 6-1/4 WE	50
2L31010	RL31 8-1/8 WE	50
2L31011	RL31 8-1/4 WE	50

WE BSP KONISK

2L31C02	RL31/C 4-1/8 WE kon.	50
2L31C03	RL31/C 4-1/4 WE kon.	50
2L31C08	RL31/C 6-1/8 WE kon.	50
2L31C09	RL31/C 6-1/4 WE kon.	50
2L31C10	RL31/C 8-1/8 WE kon.	50
2L31C11	RL31/C 8-1/4 WE kon.	50

TE BSP

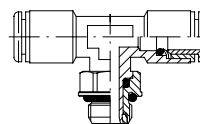

2L32002	RL32 4-1/8 TE	50
2L32003	RL32 4-1/4 TE	50
2L32008	RL32 6-1/8 TE	50
2L32009	RL32 6-1/4 TE	50
2L32010	RL32 8-1/8 TE	50
2L32011	RL32 8-1/4 TE	50

TE BSP KONISK

2L32C02	RL32/C 4-1/8 TE kon.	50
2L32C03	RL32/C 4-1/4 TE kon.	50
2L32C08	RL32/C 6-1/8 TE kon.	50
2L32C09	RL32/C 6-1/4 TE kon.	50
2L32C10	RL32/C 8-1/8 TE kon.	50
2L32C11	RL32/C 8-1/4 TE kon.	50

Artikkelnr. Benevnelse Forp.

**WE BSP/MM
TEKNOPOLYMER**

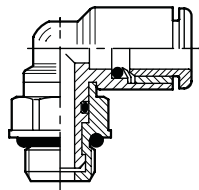

2L34001	RL34 4-M5 WE	50
2L34002	RL34 4-1/8 WE	50
2L34003	RL34 4-1/4 WE	50
2L34006	RL34 6-M5 WE	50
2L34007	RL34 6-1/8 WE	50
2L34008	RL34 6-1/4 WE	50
2L34009	RL34 8-1/8 WIE	50
2L34010	RL34 8-1/4 WE	50
2L34011	RL34 8-3/8 WE	50

**WAI BSP/MM
TEKNOPOLYMER**

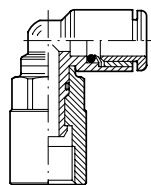

2L34F01	RL34/F 4-M5 WAI	50
2L34F06	RL34/F 6-M5 WAI	50
2L34F07	RL34/F 6-1/8 WAI	50
2L34F08	RL34/F 6-1/4 WAI	50
2L34F09	RL34/F 8-1/8 WAI	50
2L34F10	RL34/F 8-1/4 WAI	50

**TE BSP/MM
TEKNOPOLYMER**

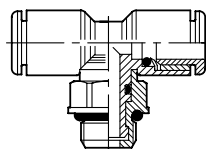

2L35001	RL35 4-M5 TE	50
2L35002	RL35 4-1/8 TE	50
2L35003	RL35 4-1/4 TE	50
2L35006	RL35 6-M5 TE	50
2L35007	RL35 6-1/8 TE	50
2L35008	RL35 6-1/4 TE	50
2L35009	RL35 8-1/8 TE	50
2L35010	RL35 8-1/4 TE	50
2L35011	RL35 8-3/8 TE	50

**TAI BSP/MM
TEKNOPOLYMER**

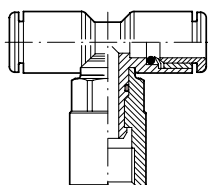

2L35F01	RL35/F 4-M5 TAI	50
2L35F06	RL35/F 6-M5 TAI	50
2L35F07	RL35/F 6-1/8 TAI	50
2L35F08	RL35/F 6-1/4 TAI	25
2L35F09	RL35/F 8-1/8 TAI	50
2L35F10	RL35/F 8-1/4 TAI	25

Artikkelnr. Benevnelse Forp.

**WE BSP/MM
HØY
TEKNOPOLYMER**

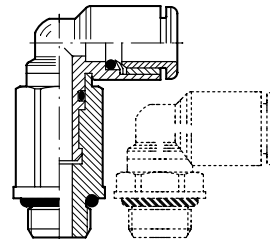

2L36001	RL36 4-M5 WE høy	50
2L36002	RL36 4-1/8 WE høy	50
2L36006	RL36 6-M5 WE høy	50
2L36007	RL36 6-1/8 WE høy	50
2L36008	RL36 6-1/4 WE høy	50
2L36009	RL36 8-1/8 WE høy	50
2L36010	RL36 8-1/4 WE høy	50

**TE BSP/MM
HØY
TEKNOPOLYMER**

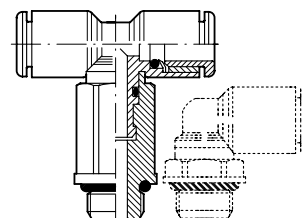

2L37001	RL37 4-M5 TE høy	50
2L37002	RL37 4-1/8 TE høy	50
2L37006	RL37 6-M5 TE høy	50
2L37007	RL37 6-1/8 TE høy	50
2L37008	RL37 6-1/4 TE høy	50
2L37009	RL37 8-1/8 TE høy	50
2L37010	RL37 8-1/4 TE høy	50

LE

2L38002	RL38 4-1/8 LE	50
2L38008	RL38 6-1/8 LE	50
2L38009	RL38 6-1/4 LE	50
2L38010	RL38 8-1/8 LE	50
2L38011	RL38 8-1/4 LE	50

WE KONISK

2L39C02	RL39/C 4-1/8 WE kon.	50
2L39C08	RL39/C 6-1/8 WE kon.	50
2L39C09	RL39/C 6-1/4 WE kon.	50
2L39C10	RL39/C 8-1/8 WE kon.	50
2L39C11	RL39/C 8-1/4 WE kon.	50



Artikkelnr.	Benevnelse	Forp.
-------------	------------	-------

K

2L40003	RL40 6 K	10
2L40004	RL40 8 K	10

**DOBBEL Y
TEKNOPOLYMER**

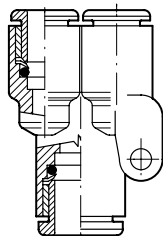
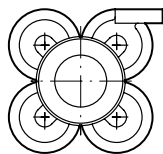

2L42001	RL42 4x4-4x1 Dobbel Y	10
2L42002	RL42 4x4-6x1 Dobbel Y	10
2L42004	RL42 6x4-6x1 Dobbel Y	10
2L42005	RL42 6x4-8x1 Dobbel Y	10

**DOBBEL
YE
TEKNOPOLYMER**

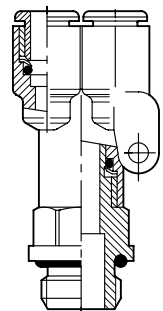
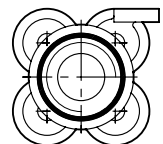

2L43001	RL43 4-M5 Dobbel YE	10
2L43002	RL43 4-1/8 Dobbel YE	10
2L43003	RL43 4-1/4 Dobbel YE	10
2L43008	RL43 6-1/8 Dobbel YE	10
2L43009	RL43 6-1/4 Dobbel YE	10

Artikkelnr.	Benevnelse	Forp.
-------------	------------	-------

**T
MULTI
TEKNOPOLYMER**

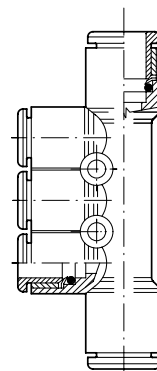

2L44001	RL44 6-4 Multi T	10
2L44003	RL44 8-6 Multi T	10

**T-KUPPLING
MULTI
GJENGE
TEKNOPOLYMER**

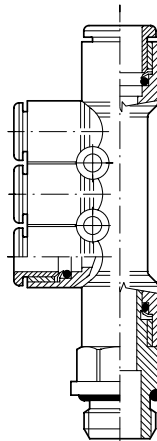

2L45001	RL45 6-4-1/8 Multi T-kuppl.	10
2L45002	RL45 6-4-1/4 Multi T-kuppl.	10
2L45008	RL45 8-6-1/4 Multi T-kuppl.	10
2L45009	RL45 8-6-3/8 Multi T-kuppl.	10

2-PLAN SVIVELKUPPLING

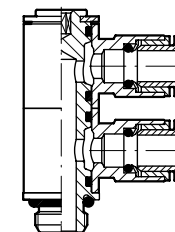

2L50001	RL50 4-M5 2-plan svivelkupl.	25
2L50002	RL50 4-1/8 2-plan svivelkupl.	25
2L50007	RL50 6-M5 2-plan svivelkupl.	25
2L50008	RL50 6-1/8 2-plan svivelkupl.	25
2L50009	RL50 6-1/4 2-plan svivelkupl.	25
2L50010	RL50 8-1/8 2-plan svivelkupl.	25
2L50011	RL50 8-1/4 2-plan svivelkupl.	25

Artikkelnr. Benevnelse Forp.

**DOBBEL
2-PLAN SVIVEL-
KUPPLING**

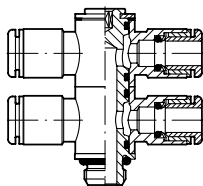

2L51001	RL51 4-M5 Dobbel 2-plan svivelk.	25
2L51002	RL51 4-1/8 Dobbel 2-plan svivelk.	25
2L51007	RL51 6-M5 Dobbel 2-plan svivelk.	25
2L51008	RL51 6-1/8 Dobbel 2-plan svivelk.	25
2L51009	RL51 6-1/4 Dobbel 2-plan svivelk.	25
2L51010	RL51 8-1/8 Dobbel 2-plan svivelk.	25
2L51011	RL51 8-1/4 Dobbel 2-plan svivelk.	25

**3-PLAN
SVIVELKUPPLING**

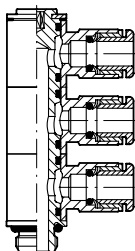

2L52002	RL52 4-1/8 3-plan svivelkopl.	25
2L52008	RL52 6-1/8 3-plan svivelkopl.	25
2L52009	RL52 6-1/4 3-plan svivelkopl.	25
2L52010	RL52 8-1/8 3-plan svivelkopl.	25
2L52011	RL52 8-1/4 3-plan svivelkopl.	25

**DOBBEL
3-PLAN SVIVEL-
KUPPLING**

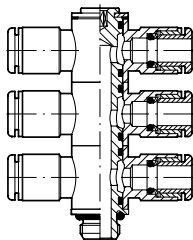

2L53002	RL53 4-1/8 Dobbel 3-plan svivelk.	25
2L53008	RL53 6-1/8 Dobbel 3-plan svivelk.	25
2L53009	RL53 6-1/4 Dobbel 3-plan svivelk.	10
2L53010	RL53 8-1/8 Dobbel 3-plan svivelk.	10
2L53011	RL53 8-1/4 Dobbel 3-plan svivelk.	10

BANJO BSP/MM

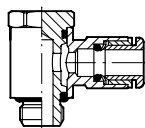

2L54001	RL54 4-M5 Banjo	50
2L54002	RL54 4-1/8 Banjo	50
2L54007	RL54 6-M5 Banjo	50
2L54008	RL54 6-1/8 Banjo	50
2L54009	RL54 6-1/4 Banjo	50
2L54010	RL54 8-1/8 Banjo	50
2L54011	RL54 8-1/4 Banjo	50

Artikkelnr. Benevnelse Forp.

DOBBEL BANJO BSP/MM

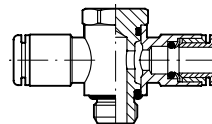

2L55001	RL55 4-M5 Dobbel banjo	50
2L55002	RL55 4-1/8 Dobbel banjo	50
2L55007	RL55 6-M5 Dobbel banjo	50
2L55008	RL55 6-1/8 Dobbel banjo	50
2L55009	RL55 6-1/4 Dobbel banjo	25
2L55010	RL55 8-1/8 Dobbel banjo	50
2L55011	RL55 8-1/4 Dobbel banjo	25

**2-PLAN BANJO
BSP/MM**

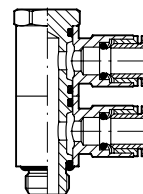

2L56001	RL56 4-M5 2-plan banjo	25
2L56002	RL56 4-1/8 2-plan banjo	25
2L56007	RL56 6-M5 2-plan banjo	25
2L56008	RL56 6-1/8 2-plan banjo	25
2L56009	RL56 6-1/4 2-plan banjo	25
2L56010	RL56 8-1/8 2-plan banjo	25
2L56011	RL56 8-1/4 2-plan banjo	25

**2-PLAN DOBBEL BANJO
BSP/MM**

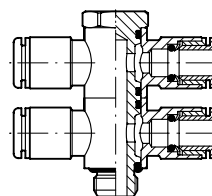

2L57001	RL57 4-M5 Dobbel 2-plan banjo	25
2L57002	RL57 4-1/8 Dobbel 2-plan banjo	25
2L57007	RL57 6-M5 Dobbel 2-plan banjo	25
2L57008	RL57 6-1/8 Dobbel 2-plan banjo	25
2L57009	RL57 6-1/4 Dobbel 2-plan banjo	25
2L57010	RL57 8-1/8 Dobbel 2-plan banjo	25
2L57011	RL57 8-1/4 Dobbel 2-plan banjo	25

Artikkelnr.	Benevnelse	Forp.
-------------	------------	-------

UTV. x UTV. BSP/MM



2101A00	A1 M5-M5 Nippel utv. x utv.	100
2101000	A1 1/8-M5 Nippel utv. x utv.	100
2101001	A1 1/8-1/8 Nippel utv. x utv.	100
2101002	A1 1/8-1/4 Nippel utv. x utv.	100
2101003	A1 1/8-3/8 Nippel utv. x utv.	50
2101004	A1 1/4-1/4 Nippel utv. x utv.	100
2101005	A1 1/4-3/8 Nippel utv. x utv.	50
2101006	A1 1/4-1/2 Nippel utv. x utv.	50
2101007	A1 3/8-3/8 Nippel utv. x utv.	50
2101008	A1 3/8-1/2 Nippel utv. x utv.	50
2101009	A1 1/2-1/2 Nippel utv. x utv.	50
2101010	A1 1/2-3/4 Nippel utv. x utv.	25
2101011	A1 3/4-3/4 Nippel utv. x utv.	25

UTV. x UTV. KONISK BSP



2102001	A2 1/8-1/8 Nippel utv. x utv.	100
2102002	A2 1/8-1/4 Nippel utv. x utv.	100
2102003	A2 1/8-3/8 Nippel utv. x utv.	50
2102004	A2 1/4-1/4 Nippel utv. x utv.	100
2102005	A2 1/4-3/8 Nippel utv. x utv.	50
2102006	A2 1/4-1/2 Nippel utv. x utv.	25
2102007	A2 3/8-3/8 Nippel utv. x utv.	50
2102008	A2 3/8-1/2 Nippel utv. x utv.	50
2102009	A2 1/2-1/2 Nippel utv. x utv.	50
2102010	A2 1/2-3/4 Nippel utv. x utv.	25
2102011	A2 3/4-3/4 Nippel utv. x utv.	25

MUFFE



2103000	A3 M5 Muffe	100
2103001	A3 1/8 Muffe	100
2103002	A3 1/4 Muffe	50
2103003	A3 3/8 Muffe	25
2103004	A3 1/2 Muffe	20

RI KONISK Kort



2104001	A4 1/4-1/8 RI	100
2104002	A4 3/8-1/8 RI	100
2104003	A4 3/8-1/4 RI	100
2104004	A4 1/2-1/4 RI	50
2104005	A4 1/2-3/8 RI	50
2104006	A4 3/4-1/2 RI	50

RI Kort



2151000	A4/Z 1/8-M5 RI	100
2151001	A4/Z 1/4-1/8 RI	100
2151002	A4/Z 3/8-1/8 RI	100
2151003	A4/Z 3/8-1/4 RI	100
2151004	A4/Z 1/2-1/4 RI	50
2151005	A4/Z 1/2-3/8 RI	50

Artikkelnr.	Benevnelse	Forp.
-------------	------------	-------

RI KONISK Lang



2105001	A5 1/8-1/8 RI	100
2105002	A5 1/8-1/4 RI	100
2105003	A5 1/4-1/4 RI	50
2105004	A5 1/4-3/8 RI	25
2105005	A5 3/8-3/8 RI	25
2105006	A5 3/8-1/2 RI	50
2105007	A5 1/2-1/2 RI	25

RI Lang



2152001	A5/Z M5-1/8 RI	100
2152002	A5/Z 1/8-1/8 RI	100
2152003	A5/Z 1/8-1/4 RI	100
2152004	A5/Z 1/4-1/4 RI	100
2152005	A5/Z 1/4-3/8 RI	50
2152006	A5/Z 3/8-3/8 RI	25
2152007	A5/Z 3/8-1/2 RI	50
2152008	A5/Z 1/2-1/2 RI	50

MUFFE



2106001	A6 1/8-1/4 Muffe	50
2106002	A6 1/8-3/8 Muffe	50
2106003	A6 1/4-3/8 Muffe	25
2106004	A6 1/4-1/2 Muffe	50
2106005	A6 3/8-1/2 Muffe	50

PLUGG



2107000	A7 M5 Plugg	100
2107001	A7 1/8 Plugg	100
2107002	A7 1/4 Plugg	100
2107003	A7 3/8 Plugg	50
2107004	A7 1/2 Plugg	50

HETTE



2108001	A8 1/8 Hette	100
2108002	A8 1/4 Hette	100
2108003	A8 3/8 Hette	50
2108004	A8 1/2 Hette	50

W-F.F.



2109001	A9 1/8 W F.F.	50
2109002	A9 1/4 W F.F.	50
2109003	A9 3/8 W F.F.	20
2109004	A9 1/2 W F.F.	20

W-M.F.



2110001	A10 1/8 W M.F.	100
2110002	A10 1/4 W M.F.	50
2110003	A10 3/8 W M.F.	25
2110004	A10 1/2 W M.F.	25

Artikkelnr.	Benevnelse	Forp.
-------------	------------	-------

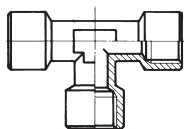
T- F.F.F.

2111001	A11 1/8 T- F.F.F.	50
2111002	A11 1/4 T- F.F.F.	20
2111003	A11 3/8 T- F.F.F.	20
2111004	A11 1/2 T- F.F.F.	10

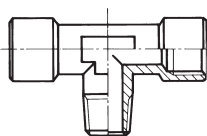
T- F.M.F.

2112001	A12 1/8 T- F.M.F.	100
2112002	A12 1/4 T- F.M.F.	20
2112003	A12 3/8 T- F.M.F.	25
2112004	A12 1/2 T- F.M.F.	10

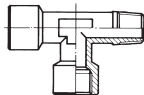
T- M.F.F.

2113001	A13 1/8 T- M.F.F.	100
2113002	A13 1/4 T- M.F.F.	20
2113003	A13 3/8 T- M.F.F.	25
2113004	A13 1/2 T- M.F.F.	10

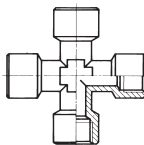
**K
F.F.F.F.**

2114001	A14 1/8 K F.F.F.F.	50
2114002	A14 1/4 K F.F.F.F.	25
2114003	A14 3/8 K F.F.F.F.	10

**W
M.M.**

2115001	A15 1/8 W M.M.	100
2115002	A15 1/4 W M.M.	100
2115003	A15 3/8 W M.M.	25
2115004	A15 1/2 W M.M.	25

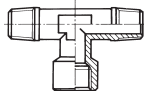
**T
M.M.M.**

2116001	A16 1/8 T- M.M.M.	100
2116002	A16 1/4 T- M.M.M.	50
2116003	A16 3/8 T- M.M.M.	20
2116004	A16 1/2 T- M.M.M.	10

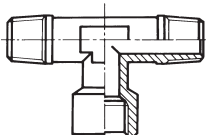
**T
M.F.M.**

2117001	A17 1/4 T- M.F.M.	50
2117002	A17 1/8 T- M.F.M.	100
2117003	A17 3/8 T- M.F.M.	20
2117004	A17 1/2 T- M.F.M.	10

Artikkelnr.	Benevnelse	Forp.
-------------	------------	-------

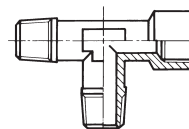
**T
F.M.M.**

2118000	A18 1/8 T- F.M.M.	100
2118001	A18 1/4 T- F.M.M.	50
2118002	A18 3/8 T- F.M.M.	25
2118003	A18 1/2 T- F.M.M.	10

SLANGEKUPPLING

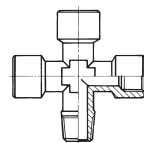

2119001	A19 7-1/8 Slangekupling	100
2119002	A19 7-1/4 Slangekupling	100
2119003	A19 8-1/8 Slangekupling	100
2119004	A19 9-1/8 Slangekupling	50
2119005	A19 9-1/4 Slangekupling	50
2119006	A19 9-3/8 Slangekupling	100
2119007	A19 12-1/4 Slangekupling	50
2119008	A19 12-3/8 Slangekupling	50
2119009	A19 12-1/2 Slangekupling	50
2119010	A19 17-3/8 Slangekupling	25
2119011	A19 17-1/2 Slangekupling	50

**K
M.F.F.F.**

2120001	A20 1/8 K M.F.F.F.	50
2120002	A20 1/4 K M.F.F.F.	25

**K-BLOKK
F.F.F.F.**

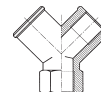

2121001	A21 1/8 K-Blokk	25
2121004	A21 1/2 K-Blokk	25
2121002	A21 1/4 K-Blokk	10
2121003	A21 3/8 K-Blokk	10

**Y
F.F.F.**

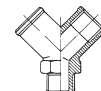
2123001	A23 1/8 Y- F.F.F.	50
2123002	A23 1/4 Y- F.F.F.	50
2123003	A23 3/8 Y- F.F.F.	25
2123004	A23 1/2 Y- F.F.F.	20

**Y
F.M.F.**

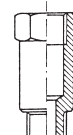
2124001	A24 1/8 Y- F.M.F.	50
2124002	A24 1/4 Y- F.M.F.	50
2124003	A24 3/8 Y- F.M.F.	25
2124004	A24 1/2 Y- F.M.F.	10

FORLENGER

2150003	A25 1/8-22 Forlenger	50
2150004	A25 1/8-42 Forlenger	50
2150005	A25 1/8-51 Forlenger	50
2150006	A25 1/4-35 Forlenger	50
2150007	A25 1/4-51 Forlenger	50



SNITTRINGARMATUR B

Artikkelnr.	Benevnelse	Forp.
-------------	------------	-------

GE KONISK

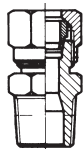

2201001	B1 4/2-1/8 GE.	100
2201002	B1 6/4-1/8 GE	100
2201003	B1 6/4-1/4 GE	100
2201004	B1 8/6-1/8 GE	100
2201005	B1 8/6-1/4 GE	50
2201006	B1 8/6-3/8 GE	100
2201007	B1 10/8-1/4 GE	50
2201008	B1 10/8-3/8 GE	50
2201009	B1 10/8-1/2 GE	25
2201010	B1 12/10-3/8 GE	50
2201011	B1 12/10-1/2 GE	20
2201012	B1 15/12-1/2 GE	25

GAI

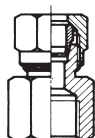

2202001	B2 6/4-1/8 GAI	100
2202002	B2 6/4-1/4 GAI	100
2202003	B2 8/6-1/8 GAI	50
2202004	B2 8/6-1/4 GAI	100
2202005	B2 8/6-3/8 GAI	50
2202006	B2 10/8-1/4 GAI	25
2202007	B2 10/8-3/8 GAI	25

G

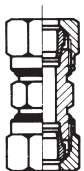

2203001	B3 4/2 G	50
2203002	B3 6/4 G	50
2203003	B3 8/6 G	50
2203004	B3 10/8 G	50
2203005	B3 12/10 G	25
2203006	B3 15/12 G	20

Artikkelnr.	Benevnelse	Forp.
-------------	------------	-------

SV

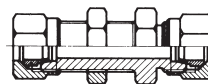

2204001	B4 6/4 SV	50
2204002	B4 8/6 SV	50
2204003	B4 10/8 SV	25
2204004	B4 12/10 SV	25
2204005	B4 15/12 SV	10

WE

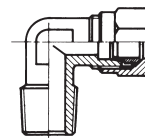

2205001	B5 4/2-1/8 WE	100
2205002	B5 6/4-1/8 WE	100
2205003	B5 6/4-1/4 WE	50
2205004	B5 8/6-1/8 WE	50
2205005	B5 8/6-1/4 WE	100
2205006	B5 8/6-3/8 WE	50
2205007	B5 10/8-1/4 WE	50
2205008	B5 10/8-3/8 WE	50
2205009	B5 10/8-1/2 WE	25
2205010	B5 12/10-3/8 WE	25
2205011	B5 12/10-1/2 WE	25
2205012	B5 15/12-1/2 WE	10

W

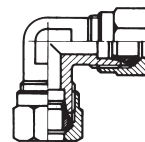

2206001	B6 4/2 W	100
2206002	B6 6/4 W	50
2206003	B6 8/6 W	50
2206004	B6 10/8 W	25
2206005	B6 12/10 W	25
2206006	B6 15/12 W	10

Artikkelnr.	Benevnelse	Forp.
-------------	------------	-------

TE

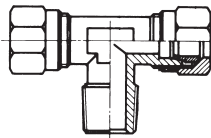

2207001	B7 4/2-1/8 TE	100
2207002	B7 6/4-1/8 TE	100
2207003	B7 6/4-1/4 TE	50
2207004	B7 8/6-1/8 TE	50
2207005	B7 8/6-1/4 TE	50
2207006	B7 8/6-3/8 TE	20
2207007	B7 10/8-1/4 TE	25
2207008	B7 10/8-3/8 TE	25
2207010	B7 12/10-3/8 TE	10
2207011	B7 12/10-1/2 TE	10
2207012	B7 15/12-1/2 TE	10

LE

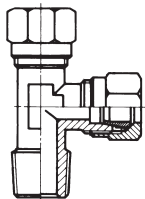

2208001	B8 6/4-1/8 LE	100
2208002	B8 6/4-1/4 LE	50
2208003	B8 8/6-1/8 LE	50
2208004	B8 8/6-1/4 LE	50
2208005	B8 8/6-3/8 LE	25
2208006	B8 10/8-1/4 LE	25
2208007	B8 10/8-3/8 LE	25
2208009	B8 12/10-3/8 LE	10
2208010	B8 12/10-1/2 LE	10
2208011	B8 15/12-1/2 LE	10

T

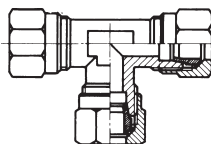

2209001	B9 4/2 T	100
2209002	B9 6/4 T	50
2209003	B9 8/6 T	50
2209004	B9 10/8 T	20
2209005	B9 12/10 T	10
2209006	B9 15/12 T	10

Artikkelnr.	Benevnelse	Forp.
-------------	------------	-------

MUTTER



2210001	B10 4/2 Mutter	100
2210002	B10 6/4 Mutter	100
2210003	B10 8/6 Mutter	100
2210004	B10 10/8 Mutter	50
2210005	B10 12/10 Mutter	50
2210006	B10 15/12 Mutter	25

SNITTRING



2211001	B11 4/2 Snittring	100
2211002	B11 6/4 Snittring	100
2211003	B11 8/6 Snittring	100
2211004	B11 10/8 Snittring	100
2211005	B11 12/10 Snittring	100
2211006	B11 15/12 Snittring	100

STØTTEHYLSE



2212001	B12 6/4 Støttehylse	100
2212002	B12 8/6 Støttehylse	100
2212003	B12 10/8 Støttehylse	100
2212004	B12 12/10 Støttehylse	100
2212005	B12 15/12 Støttehylse	100

Artikkelnr.	Benevnelse	Forp.
-------------	------------	-------

GE KONISK



2301001	C1 6/4-1/8 GE	100
2301002	C1 6/4-1/4 GE	100
2301003	C1 8/6-1/8 GE	50
2301004	C1 8/6-1/4 GE.	100
2301005	C1 8/6-3/8 GE	100
2301006	C1 10/8-1/4 GE	50
2301007	C1 10/8-3/8 GE	50
2301008	C1 10/8-1/2 GE	50
2301009	C1 12/10-3/8 GE	25
2301010	C1 12/10-1/2 GE	50
2301015	C1 15/12-1/2 GE	25
2301017	C1 5/3-1/8 GE	50

GE

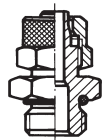

2351001	C1/Z 4/2-M5 GE	100
2351002	C1/Z 6/4-M5 GE	100
2351003	C1/Z 6/4-1/8 GE	50
2351004	C1/Z 6/4-1/4 GE.	50
2351005	C1/Z 8/6-1/8 GE	100
2351006	C1/Z 8/6-1/4 GE	50
2351007	C1/Z 8/6-3/8 GE	100
2351008	C1/Z 10/8-1/4 GE	100
2351009	C1/Z 10/8-3/8 GE	50
2351010	C1/Z 10/8-1/2 GE	50
2351011	C1/Z 12/10-3/8 GE	25
2351012	C1/Z 12/10-1/2 GE.	50
2351100	C1/Z 10/8-1/8 GE	50

GE

(uten O-ring)

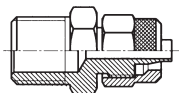

2356001	C1/C 5/3-M5 GE	50
2356002	C1/C 6/4-M6 GE	50
2356003	C1/C 6/4-M12x1,5 GE	50
2356004	C1/C 6/4-3/8 GE	50
2356005	C1/C 8/6-M12x1,5 GE	50

GAI



2302001	C2 6/4-1/8 GAI	100
2302002	C2 6/4-1/4 GAI	50
2302003	C2 8/6-1/8 GAI	100
2302004	C2 8/6-1/4 GAI	50
2302005	C2 8/6-3/8 GAI	50
2302006	C2 10/8-1/4 GAI	100
2302007	C2 10/8-3/8 GAI	50
2302008	C2 10/8-1/2 GAI	25
2302012	C2 6/4-3/8 GAI	50

Artikkelnr.	Benevnelse	Forp.
-------------	------------	-------

G



2303001	C3 6/4 G	100
2303002	C3 8/6 G	50
2303003	C3 10/8 G	100
2303004	C3 12/10 G	50

SV

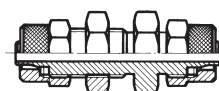

2304001	C4 6/4 SV	100
2304002	C4 8/6 SV	50
2304003	C4 10/8 SV	50
2304004	C4 12/10 SV	50

WE KONISK

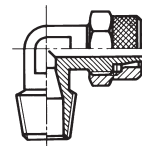

2305001	C5 6/4-1/8 WE	100
2305002	C5 6/4-1/4 WE	50
2305003	C5 8/6-1/8 WE	50
2305004	C5 8/6-1/4 WE	50
2305005	C5 8/6-3/8 WE	100
2305006	C5 10/8-1/4 WE	100
2305007	C5 10/8-3/8 WE	25
2305008	C5 10/8-1/2 WE	50
2305009	C5 12/10-3/8 WE	50
2305010	C5 12/10-1/2 WE	25
2305016	C5 5/3-1/8 WE	100
2305017	C5 15/12-1/2 WE	25

WAI

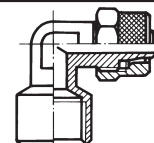

2352001	C5/F 6/4-1/8 WAI	50
2352002	C5/F 8/6-1/4 WAI	50

Artikkelnr.	Benevnelse	Forp.
-------------	------------	-------

WE (uten O-ring)

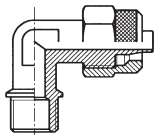

2357001	C5/C 6/4-M12x1,5 WE	50
2357002	C5/C 8/6-M12x1,5 WE	50

W

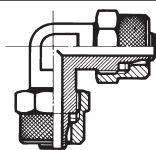

2306001	C6 6/4 W	50
2306002	C6 8/6 W	100
2306003	C6 10/8 W	50
2306004	C6 12/10 W	25
2306006	C6 15/12,5 W	25

TE

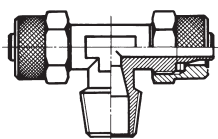

2307001	C7 6/4-1/8 TE	100
2307002	C7 6/4-1/4 TE	100
2307003	C7 8/6-1/8 TE	50
2307004	C7 8/6-1/4 TE	50
2307005	C7 8/6-3/8 TE	50
2307006	C7 10/8-1/4 TE	50
2307007	C7 10/8-3/8 TE	50
2307008	C7 10/8-1/2 TE	25
2307009	C7 12/10-3/8 TE	25
2307010	C7 12/10-1/2 TE	25
2307015	C7 5/3-1/8 TE	50
2307016	C7 15/12-1/2 TE	10

LE

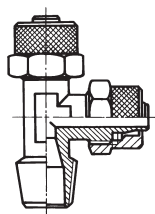

2308001	C8 6/4-1/8 LE	100
2308002	C8 6/4-1/4 LE	100
2308003	C8 8/6-1/8 LE	50
2308004	C8 8/6-1/4 LE	50
2308005	C8 8/6-3/8 LE	50
2308006	C8 10/8-1/4 LE	50
2308007	C8 10/8-3/8 LE	50
2308008	C8 10/8-1/2 LE	25
2308009	C8 12/10-3/8 LE	25
2308010	C8 12/10-1/2 LE	25
2308012	C8 5/3-1/8 LE	50

Artikkelnr.	Benevnelse	Forp.
-------------	------------	-------

T

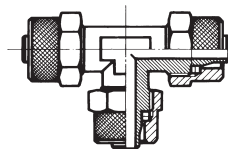

2309001	C9 6/4 T	100
2309002	C9 8/6 T	50
2309003	C9 10/8 T	50
2309004	C9 12/10 T	25
2309007	C9 15/12,5 T	10

MUTTER



2310001	C10 5/3 M7x0,5 Mutter	100
2310002	C10 6/4 M8x0,5 Mutter	100
2310003	C10 6/4 M10x1 Mutter	100
2310004	C10 8/6 M12x1 Mutter	100
2310005	C10 10/8 M14x1 Mutter	100
2310006	C10 12/10 M16x1 Mutter	100
2310009	C10 5/3 M7x0,75 Mutter	100
2310010	C10 6/4 M8x0,75 Mutter	100
2310011	C10 15/12,5 M20x1 Mutter	100

K

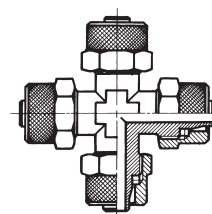

2311001	C11 6/4 K	50
2311002	C11 8/6 K	50
2311003	C11 10/8 K	25

Artikkelnr. Benevnelse Forp.

ENKEL BANJO

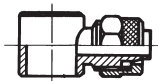

2405000	D5 4/2-M5 Enkel banjo	100
2405001	D5 6/4-M5 Enkel banjo	100
2405002	D5 6/4-1/8 Enkel banjo	100
2405003	D5 6/4-1/4 Enkel banjo	100
2405005	D5 8/6-1/8 Enkel banjo	100
2405006	D5 8/6-1/4 Enkel banjo	100
2405007	D5 8/6-3/8 Enkel banjo	25
2405009	D5 10/8-1/4 Enkel banjo	50
2405010	D5 10/8-3/8 Enkel banjo	50
2405011	D5 10/8-1/2 Enkel banjo	20
2405012	D5 12/10-1/2 Enkel banjo	20

DOBBL BANJO



2406001	D6 6/4-1/8 Dobbel banjo	100
2406002	D6 6/4-1/4 Dobbel banjo	50
2406004	D6 8/6-1/8 Dobbel banjo	50
2406005	D6 8/6-1/4 Dobbel banjo	50
2406006	D6 8/6-3/8 Dobbel banjo	50
2406008	D6 10/8-1/4 Dobbel banjo	50
2406009	D6 10/8-3/8 Dobbel banjo	25
2406010	D6 10/8-1/2 Dobbel banjo	25
2406011	D6 12/10-1/2 Dobbel banjo	25

BANJOBOLT



2407001	D7 M5 Banjobolt	100
2407002	D7 1/8 Banjobolt	100
2407003	D7 1/4 Banjobolt	50
2407004	D7 3/8 Banjobolt	50
2407005	D7 1/2 Banjobolt.	25
2407006	D7 M12x1,5 Banjobolt	50
MED O-RING		
2407102	D7 1/8 Banjobolt med O-ring	100
2407103	D7 1/4 Banjobolt med O-ring	50
2407104	D7 3/8 Banjobolt med O-ring	50

DOBBL BANJOBOLT



2408001	D8 1/8 Dobbel Banjobolt	100
2408002	D8 1/4 Dobbel Banjobolt	50
2408003	D8 3/8 Dobbel Banjobolt	20
2408004	D8 1/2 Dobbel Banjobolt	25
MED O-RING		
2408102	D8 1/8 Dobbel Banjobolt med O-ring	100
2408103	D8 1/4 Dobbel Banjobolt med O-ring	50
2408104	D8 3/8 Dobbel Banjobolt med O-ring	20

Artikkelnr. Benevnelse Forp.

BANJOBOLT INN. GJ.



2409001	D9 1/8 Banjobolt m/innv. gj.	100
2409002	D9 1/4 Banjobolt m/innv. gj.	50
2409003	D9 3/8 Banjobolt m/innv. gj.	50
2409004	D9 1/2 Banjobolt m/innv. gj.	25
MED O-RING		
2409102	D9 1/8 Banjobolt m/innv. gj. med O-ring	100
2409103	D9 1/4 Banjobolt m/innv. gj. med O-ring	50
2409104	D9 3/8 Banjobolt m/innv. gj. med O-ring	20

DOBBL BANJOBOLT INN. GJ.



2410001	D10 1/8 Dobbel Banjobolt m/innv. gj.	100
2410002	D10 1/4 Dobbel Banjobolt m/innv. gj.	50
2410003	D10 3/8 Dobbel Banjobolt m/innv. gj.	25
2410004	D10 1/2 Dobbel Banjobolt m/innv. gj.	10
MED O-RING		
2410102	D10 1/8 Dobbel banjobolt med O-ring	100
2410103	D10 1/4 Dobbel banjobolt med O-ring	50
2410104	D10 3/8 Dobbel banjobolt med O-ring	25

PAKNING

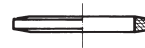

2411001	D11 M5 Nylonpakning	100
2411002	D11 1/8 Aluminiumpakning	200
2411003	D11 1/4 Aluminiumpakning	100
2411004	D11 3/8 Aluminiumpakning	100
2411005	D11 1/2 Aluminiumpakning	100

ENKEL BANJO INN. GJ.

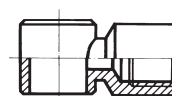

2412001	D12 1/8 Enkel banjo innv.	50
2412002	D12 1/4 Enkel banjo innv.	50
2412003	D12 3/8 Enkel banjo innv.	50

ENKEL BANJO SNITTRING

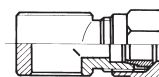

2417006	D17 4/2-1/8 Enkel banjo	50
2417003	D17 6/4-1/4 Enkel banjo	50
2417002	D17 6/4-1/8 Enkel banjo	50
2417005	D17 8/6-1/4 Enkel banjo	50
2417004	D17 8/6-1/8 Enkel banjo	50

STRUPE-/STRUPETILBAKESLAGSVENTILER MRFO

Artikkelnr.	Benevnelse	Forp.
-------------	------------	-------

STRUPETILBAKESLAGSVENTIL FOR SYLINDER-MONTERING MED PNEUMATIKKFITTINGS

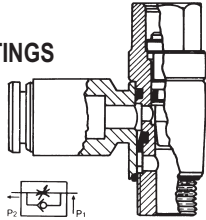

9001001	MRFO C 4-M5 Strupetilb.	10
9001011	MRFO C 4-1/8 Strupetilb.	10
9001002	MRFO C 5-M5 Strupetilb.	10
9001012	MRFO C 5-1/8 Strupetilb.	10
9001003	MRFO C 6-1/8 Strupetilb.	10
9001004	MRFO C 6-1/4 Strupetilb.	10
9001005	MRFO C 8-1/8 Strupetilb.	10
9001006	MRFO C 8-1/4 Strupetilb.	10
9001008	MRFO C 10-1/4 Strupetilb.	10

STRUPEVENTIL MED PNEUMATIKKFITTINGS

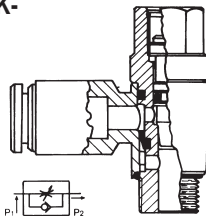

9001601	MRFO B 4-M5 Strupeventil	10
9001602	MRFO B 4-1/8 Strupeventil	10
9001603	MRFO B 5-M5 Strupeventil	10
9001604	MRFO B 5-1/8 Strupeventil	10
9001605	MRFO B 6-1/8 Strupeventil	10
9001606	MRFO B 6-1/4 Strupeventil	10
9001607	MRFO B 8-1/8 Strupeventil	10
9001608	MRFO B 8-1/4 Strupeventil	10
9001609	MRFO B 10-1/4 Strupeventil	10

STRUPETILBAKESLAGSVENTIL FOR VENTIL-MONTERING MED PNEUMATIKK FITTINGS

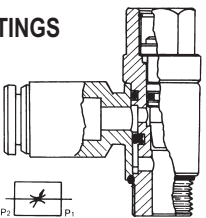

9001111	MRFO V 4-1/8 Strupetilb.	10
9001112	MRFO V 5-1/8 Strupetilb.	10
9001101	MRFO V 6-1/8 Strupetilb.	10
9001102	MRFO V 6-1/4 Strupetilb.	10
9001103	MRFO V 8-1/8 Strupetilb.	10
9001104	MRFO V 8-1/4 Strupetilb.	10
9001106	MRFO V 10-1/4 Strupetilb.	10

Artikkelnr.	Benevnelse	Forp.
-------------	------------	-------

STRUPETILBAKESLAGS VENTIL FOR VENTIL-MONTERING MED INNV. GJ.

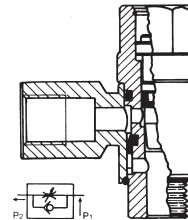

9001120	MRFO VF 1/8-1/8 Strupetilb.	10
9001121	MRFO VF 1/4-1/4 Strupetilb..	10

STRUPETILBAKESLAGSVENTIL FOR SYLINDER-MONTERING MED INNV. GJ.

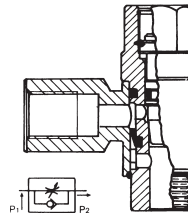

9001020	MRFO CF 1/8-1/8 Strupetilb.	10
9001021	MRFO CF 1/4-1/4 Strupetilb.	10

STRUPEVENTIL MED INNV. GJ.

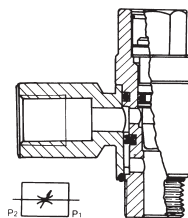

9001620	MRFO BF 1/8-1/8 Strupeventil	10
9001621	MRFO BF 1/4-1/4 Strupeventil	10



STRUPE-/STRUPETILBAKESLAGSVENTILER MRFN

Artikkelnr. Benevnelse Forp.

STRUPETILBAKESLAGSVENTIL FOR SYLINDER- MONTERING MED PNEUMATIKK FITTINGS

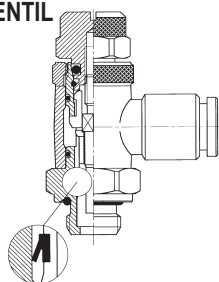

9031001	MRF/C 4-M5 Strupetilb.	10
9031002	MRF/C 4-1/8 Strupetilb.	10
9031003	MRF/C 5-M5 Strupetilb.	10
9031004	MRF/C 5-1/8 Strupetilb.	10
9031005	MRF/C 6-M5 Strupetilb.	10
9031006	MRF/C 6-1/8 Strupetilb.	10
9031007	MRF/C 6-1/4 Strupetilb.	10
9031008	MRF/C 8-1/8 Strupetilb.	10
9031009	MRF/C 8-1/4 Strupetilb.	10
9031011	MRF/C 10-1/4 Strupetilb.	10
9031012	MRF/C 10-3/8 Strupetilb.	10
9031014	MRF/C 12-1/4 Strupetilb.	10
9031015	MRF/C 12-3/8 Strupetilb.	10
9031016	MRF/C 12-1/2 Strupetilb.	10

Artikkelnr. Benevnelse Forp.

STRUPEVENTIL MED PNEUMATIKK- FITTINGS

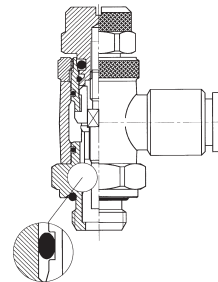

9031201	MRF/B 4-M5 Strupeventil	10
9031202	MRF/B 4-1/8 Strupeventil	10
9031203	MRF/B 5-M5 Strupeventil	10
9031204	MRF/B 5-1/8 Strupeventil	10
9031205	MRF/B 6-M5 Strupeventil	10
9031206	MRF/B 6-1/8 Strupeventil	10
9031207	MRF/B 6-1/4 Strupeventil	10
9031208	MRF/B 8-1/8 Strupeventil	10
9031209	MRF/B 8-1/4 Strupeventil	10
9031211	MRF/B 10-1/4 Strupeventil	10
9031212	MRF/B 10-3/8 Strupeventil	10
9031214	MRF/B 12-1/4 Strupeventil	10
9031215	MRF/B 12-3/8 Strupeventil	10
9031216	MRF/B 12-1/2 Strupeventil	10

STRUPETILBAKESLAGSVENTIL FOR VENTIL- MONTERING MED PNEUMATIKK FITTINGS

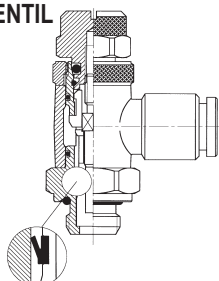

9031101	MRF/V 4-M5 Strupetilb.	10
9031102	MRF/V 4-1/8 Strupetilb.	10
9031103	MRF/V 5-M5 Strupetilb.	10
9031104	MRF/V 5-1/8 Strupetilb.	10
9031105	MRF/V 6-M5 Strupetilb.	10
9031106	MRF/V 6-1/8 Strupetilb.	10
9031107	MRF/V 6-1/4 Strupetilb.	10
9031108	MRF/V 8-1/8 Strupetilb.	10
9031109	MRF/V 8-1/4 Strupetilb.	10
9031111	MRF/V 10-1/4 Strupetilb.	10
9031112	MRF/V 10-3/8 Strupetilb.	10
9031114	MRF/V 12-1/4 Strupetilb.	10
9031115	MRF/V 12-3/8 Strupetilb.	10
9031116	MRF/V 12-1/2 Strupetilb.	10

STRUPETILBAKESLAGSVENTIL FOR SYLINDERMONTERING MED INNV. GJ.

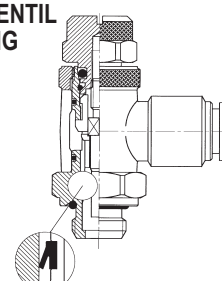

9031301	MRF/CF 1/8-1/8 Strupetilb.	10
9031302	MRF/CF 1/4-1/4 Strupetilb.	10
9031303	MRF/CF 3/8-3/8 Strupetilb.	10

STRUPETILBAKESLAGSVENTIL FOR VENTILMONTERING MED INNV. GJ.

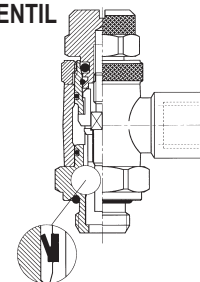

9031401	MRF/VF 1/8-1/8 Strupetilb.	10
9031402	MRF/VF 1/4-1/4 Strupetilb.	10
9031403	MRF/VF 3/8-3/8 Strupetilb.	10

Artikkelnr. Benevnelse Forp.

**STRUPEVENTIL MED
INN. GJ.**

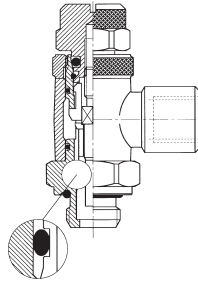

9031501	MRFBF 1/8-1/8 Strupeventil	10
9031502	MRFBF 1/4-1/4 Strupeventil	10
9031503	MRFBF 3/8-3/8 Strupeventil	10

Artikkelnr. Benevnelse Forp.

**STRUPETILBAKESLAGSVENTIL
TEKNOPOLYMER
FOR VENTIL-
MONTERING MED
PNEUMATIKK FITTINGS**

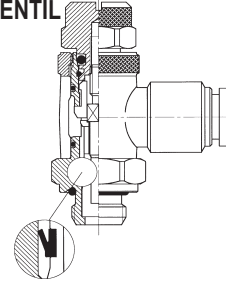

9021101	MRFTV 4-M5 Strupetilb.	10
9021102	MRFTV 4-1/8 Strupetilb.	10
9021103	MRFTV 5-M5 Strupetilb.	10
9021104	MRFTV 5-1/8 Strupetilb.	10
9021105	MRFTV 6-M5 Strupetilb.	10
9021106	MRFTV 6-1/8 Strupetilb.	10
9021107	MRFTV 6-1/4 Strupetilb.	10
9021108	MRFTV 8-1/8 Strupetilb.	10
9021109	MRFTV 8-1/4 Strupetilb.	10
9021111	MRFTV 10-1/4 Strupetilb.	10
9021112	MRFTV 10-3/8 Strupetilb.	10
9021114	MRFTV 12-1/4 Strupetilb.	10
9021115	MRFTV 12-3/8 Strupetilb.	10
9021116	MRFTV 12-1/2 Strupetilb.	10

**STRUPETILBAKESLAGSVENTIL
TEKNOPOLYMER
FOR SYLINDER-
MONTERING MED
PNEUMATIKK FITTINGS**

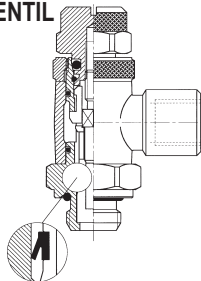

9021001	MRFT/C 4-M5 Strupetilb.	10
9021002	MRFT/C 4-1/8 Strupetilb.	10
9021003	MRFT/C 5-M5 Strupetilb.	10
9021004	MRFT/C 5-1/8 Strupetilb.	10
9021005	MRFT/C 6-M5 Strupetilb.	10
9021006	MRFT/C 6-1/8 Strupetilb.	10
9021007	MRFT/C 6-1/4 Strupetilb.	10
9021008	MRFT/C 8-1/8 Strupetilb.	10
9021009	MRFT/C 8-1/4 Strupetilb.	10
9021011	MRFT/C 10-1/4 Strupetilb.	10
9021012	MRFT/C 10-3/8 Strupetilb.	10
9021014	MRFT/C 12-1/4 Strupetilb.	10
9021015	MRFT/C 12-3/8 Strupetilb.	10
9021016	MRFT/C 12-1/2 Strupetilb.	10

**STRUPEVENTIL
TEKNOPOLYMER
MED PNEUMATIKK-
FITTINGS**

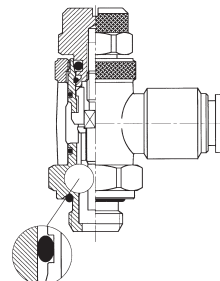

9021201	MRFT/B 4-M5 Strupeventil	10
9021202	MRFT/B 4-1/8 Strupeventil	10
9021203	MRFT/B 5-M5 Strupeventil	10
9021204	MRFT/B 5-1/8 Strupeventil	10
9021205	MRFT/B 6-M5 Strupeventil	10
9021206	MRFT/B 6-1/8 Strupeventil	10
9021207	MRFT/B 6-1/4 Strupeventil	10
9021208	MRFT/B 8-1/8 Strupeventil	10
9021209	MRFT/B 8-1/4 Strupeventil	10
9021211	MRFT/B 10-1/4 Strupeventil	10
9021212	MRFT/B 10-3/8 Strupeventil	10
9021214	MRFT/B 12-1/4 Strupeventil	10
9021215	MRFT/B 12-3/8 Strupeventil	10
9021216	MRFT/B 12-1/2 Strupeventil	10



STRUPE-/ STRUPETILBAKE- SLAGSVENTILER RFL

Artikkelnr. Benevnelse Forp.

STRUPETILBAKESLAGSVENTIL IN-LINE

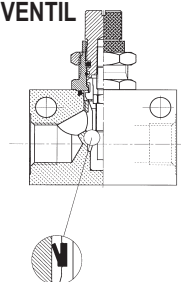

9041001	RFL U M5 Strupetilbakeslagsventil	10
9041002	RFL U 1/8 Strupetilbakeslagsventil	10
9041003	RFL U 1/4 Strupetilbakeslagsventil	10
9041004	RFL U 3/8 Strupetilbakeslagsventil	5
9041005	RFL U 1/2 Strupetilbakeslagsventil	5

STRUPEVENTIL IN-LINE

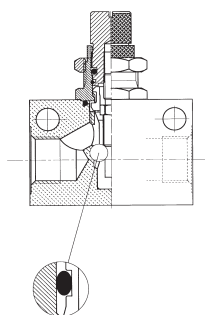

9041201	RFL B M5 Strupeventil	10
9041202	RFL B 1/8 Strupeventil	10
9041203	RFL B 1/4 Strupeventil	10
9041204	RFL B 3/8 Strupeventil	5
9041205	RFL B 1/2 Strupeventil	5

STRUPE-/STRUPETILBAKESLAGSVENTIL IN-LINE MED PNEUMATISK FITTINGS RFL-R

Artikkelnr. Benevnelse

RFL R RØR-RØR STRUPETILBAKESLAGSVENTIL

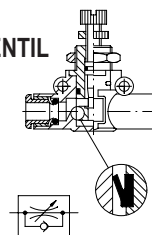

9041316	RFL R U 6-6 Strupetilbakeslagsventil
9041324	RFL R U 8-8 Strupetilbakeslagsventil

RFL R GJ.-RØR STRUPETILBAKESLAGSVENTIL (for sylindermontering)

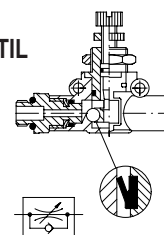

9041408	RFL R U 1/8-6 Strupetilbakeslagsventil
9041409	RFL R U 1/4-6 Strupetilbakeslagsventil
9041410	RFL R U 1/8-8 Strupetilbakeslagsventil
9041411	RFL R U 1/4-8 Strupetilbakeslagsventil
9041412	RFL R U 3/8-8 Strupetilbakeslagsventil

RFL R RØR-GJ. STRUPETILBAKESLAGSVENTIL (for ventilmontering)

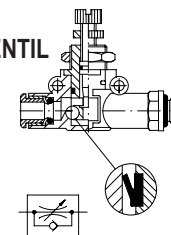

9041508	RFL R U 6-1/8 Strupetilbakeslagsventil
9041509	RFL R U 6-1/4 Strupetilbakeslagsventil
9041510	RFL R U 8-1/8 Strupetilbakeslagsventil
9041511	RFL R U 8-1/4 Strupetilbakeslagsventil
9041512	RFL R U 8-3/8 Strupetilbakeslagsventil

RFL R RØR-RØR STRUPEVENTIL

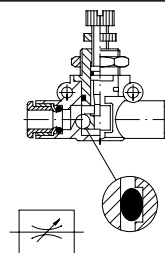

9041616	RFL R B 6-6 Strupeventil
9041624	RFL R B 8-8 Strupeventil

RFL R GJ.-RØR STRUPEVENTIL

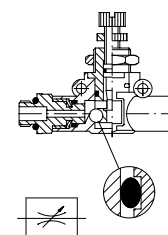

9041708	RFL R B 1/8-6 Strupeventil
9041709	RFL R B 1/4-6 Strupeventil
9041710	RFL R B 1/8-8 Strupeventil
9041711	RFL R B 1/4-8 Strupeventil
9041712	RFL R B 3/8-8 Strupeventil

REGULATORER MINIATYRFORMAT RML-RMS-RMC

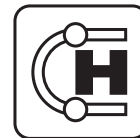

Artikkelnr. Benevnelse

REGULATOR IN-LINE RØR-RØR

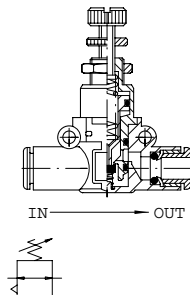

9061316 RML 6-6
9061324 RML 8-8

Artikkelnr. Benevnelse

REGULATOR PATRONUTFØRELSE

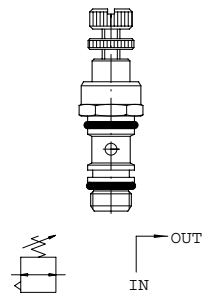

9061001 RMS 1/8
9061002 RMS 1/4

REGULATOR IN-LINE GJ.-RØR

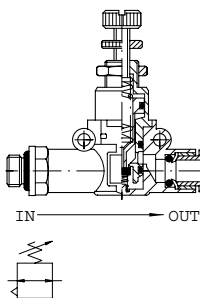

9061408 RML 1/8-6
9061409 RML 1/4-6
9061410 RML 1/8-8
9061411 RML 1/4-8
9061412 RML 3/8-8

REGULATOR 90°

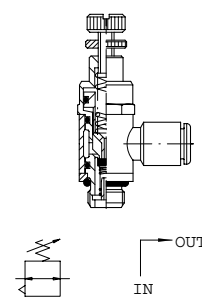

9061102 RMC 1/8-4
9061108 RMC 1/8-6
9061109 RMC 1/4-6
9061110 RMC 1/8-8
9061111 RMC 1/4-8

REGULATOR IN-LINE RØR-GJ.

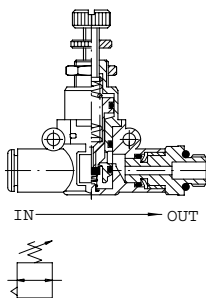

9061508 RML 6-1/8
9061509 RML 6-1/4
9061510 RML 8-1/8
9061511 RML 8-1/4
9061512 RML 8-3/8

VERKTØY FOR RMS SETE

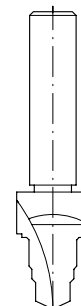

9062001 Verktøy for RMS sete 1/8
9062002 Verktøy for RMS sete 1/4



HURTIGKUPLINGER FOR TRYKKLUFT IAC

Artikkelnr.	Benevnelse	Forp.
-------------	------------	-------

HUN UTV. GJ.

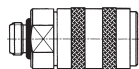

0101001	01 Mini 1/8 Hun utv. gj.	50
0101002	02 Mini 1/4 Hun utv. gj.	50
0201101	101 100 1/4 Hun utv. gj.	25
0301201	201 200 3/8 Hun utv. gj.	25
0300202	201/A 200 1/4 Hun utv. gj.	25

HUN INNV. GJ.

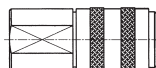

0101003	03 Mini 1/8 Hun innv. gj.	50
0101004	04 Mini 1/4 Hun innv. gj.	50
0201102	102 100 1/4 Hun innv. gj.	25
0301202	202 200 3/8 Hun innv. gj.	25
0401302	302 300 1/2 Hun innv. gj.	10

HUN FOR PLASTRØR

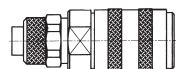

0101005	05 Mini 6/4 Hun, rør	50
0101006	06 Mini 8/6 Hun, rør	50

HUN FOR PLASTRØR, MED FJÆR

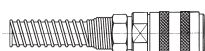

0101007	07 Mini 6/4 Hun, fjær	20
0101008	08 Mini 8/6 Hun, fjær	20

HAN UTV. GJ.

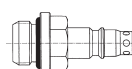

0102011	11 Mini 1/8 Han, utv.	50
0102012	12 Mini 1/4 Han, utv.	50
0202111	111 100 1/4 Han, utv.	25
0302211	211 200 3/8 Han, utv.	25
0303205	211/A 200 1/4 Han, utv.	25
0402311	311 300 1/2 Han, utv.	20

Artikkelnr.	Benevnelse	Forp.
-------------	------------	-------

HAN INNV. GJ.

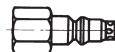

0102013	13 Mini 1/8 Han, innv.	50
0102014	14 Mini 1/4 Han, innv.	50
0202112	112 100 1/4 Han, innv.	25
0302212	212 200 3/8 Han, innv.	25
0402312	312 300 1/2 Han, innv.	20

HAN FOR PLASTRØR

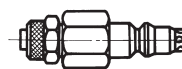

0102015	15 Mini 6/4 Han, rør	50
0102016	16 Mini 8/6 Han, rør	50

HAN FOR PLASTRØR, MED FJÆR



0102017	17 Mini 6/4 Han, fjær	50
0102018	18 Mini 8/6 Han, fjær	50

C1/Z MED FJÆR

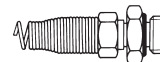

0010001	Fjærkuppl. C1/Z 8/6-1/4	25
0010002	Fjærkuppl. C1/Z 8/6-3/8	25
0010003	Fjærkuppl. C1/Z 10/8-1/4	25
0010004	Fjærkuppl. C1/Z 10/8-3/8	25
0010005	Fjærkuppl. C1/Z 12/10-3/8	25

KUPLING FOR GUMMISLANGE

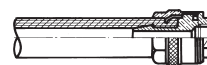

2601001	40 1/4 6x14 Slangekupling	25
2601002	41 1/4 8x17 Slangekupling	25
2601003	42 1/4 10x19 Slangekupling	25
2601004	43 F 1/2 13x23 Slangekupling	25

VRIDBAR, MED FJÆR



2501010	50 6/4-1/4 Vridbar med fjær	50
2501011	51 8/6-1/4 Vridbar med fjær	50
2501012	52 10/8-3/8 Vridbar med fjær	25
2501013	53 12/10-3/8 Vridbar med fjær	20

HURTIGKUPLINGER FOR FORMSTØPNINGS- MASKINER ICS

Artikkelnr.	Benevnelse	Forp.
-------------	------------	-------

HUN INNV.

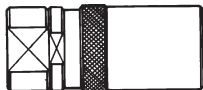

0600040	503V F 1/8 SV Hun innv.	25
0500040	403V F 1/4 SV Hun innv	10

HUN INNV. M/TILBAKESLAGS- VENTIL



0601040	501V 1/8 Hun innv. m/tilbakeslagsventil	25
0501040	401V F 1/4 Hun innv. m/tilbakeslagsventil	10

HAN UTV. (med O-ring av Viton)

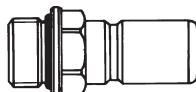

0602001	511 M 1/8 S.V Han utv.	100
0502001	411 M 1/4 S.V Han utv.	50

HAN INNV.



0602002	512 F 1/8 Han innv.	100
0502002	412 F 1/4 Han innv.	50

FORLENGER

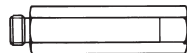

9101402	551 1/8 Forlenger	20
9201402	451 1/4 Forlenger	10

Slangekupling (med O-ring av Viton)



2153001	Slangekup. A19 7-1/8 VITON	100
2153002	Slangekup. A19 7-1/4 VITON	100
2153004	Slangekup. A19 9-1/8 VITON	100
2153005	Slangekup. A19 9-1/4 VITON	50
2153007	Slangekup. A19 12-1/4 VITON	50

HURTIG- LUFTER VSR

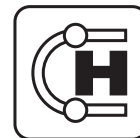

Artikkelnr.	Benevnelse	Forp.
-------------	------------	-------

HURTIGLUFTER

9101201	VSR 1/8 Hurtiglufter	20
9201201	VSR 1/4 Hurtiglufter	10
9401201	VSR 1/2 Hurtiglufter	5

MEMBRAN FOR VSR

9151501	MB VSR 1/8 Membran	10
9251501	MB VSR 1/4 Membran	10
9451501	MB VSR 1/2 Membran	10

MANIFOLD MED KOBLINGER

Artikkelnr.	Beskrivning
-------------	-------------

MANIFOLD MED KOBLINGER

7304106	Manifold med koblinger 6x4mm
7304112	Manifold med koblinger 12x4mm
7306206	Manifold med koblinger 6x6mm
7306212	Manifold med koblinger 12x6mm
7308306	Manifold med koblinger 6x8mm
7308312	Manifold med koblinger 12x8mm

Artikkelnr.	Benevnelse	Forp.
-------------	------------	-------

POLYURETANRØR

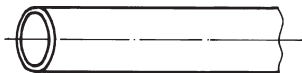

90111102	PU 3/1,8 Blå 50m	50
90111112	PU 4/2 Blå 50m	50
90111122	PU 5/3 Blå 50m	50
90111132	PU 6/4 Blå 50m	50
90111142	PU 8/6 Blå 50m	50
90111152	PU 10/8 Blå 50m	50
90111162	PU 12/9 Blå 50m	50
90111171	PU 14/11 Blå 25m	25
90111212	PU 4/2 Natur 50m	50
90111222	PU 5/3 Natur 50m	50
90111232	PU 6/4 Natur 50m	50
90111242	PU 8/6 Natur 50m	50
90111252	PU 10/8 Natur 50m	50
90111262	PU 12/9 Natur 50m	50
90111271	PU 14/11 Natur 25m	25
90111312	PU 4/2 Svart 50m	50
90111322	PU 5/3 Svart 50m	50
90111332	PU 6/4 Svart 50m	50
90111342	PU 8/6 Svart 50m	50
90111352	PU 10/8 Svart 50m	50
90111362	PU 12/9 Svart 50m	50
90111371	PU 14/11 Svart 25m	25
90115732	PU-SOFT 6/4 Grå 50m	50
90115742	PU-SOFT 8/6 Grå 50m	50

POLYURETAN DUO

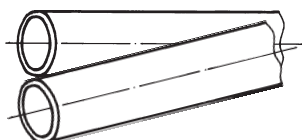

90211112	PU-DUO 4/2 blå/svart	50
90211132	PU-DUO 6/4 blå/svart	50
90211142	PU-DUO 8/6 blå/svart	50
90211242	PU-DUO 8/6 grå/svart	50

SPIRALSLANGE PU-DUO



90250103	2xPU 4/2-2,5m Spiral	
90250303	2xPU 6/4-2,5m Spiral	
90250403	2xPU 8/6-2,5m Spiral	
90250503	2xPU 10/8-2,5m Spiral	

TILBEHØR

Artikkelnr.	Benevnelse	Forp.
-------------	------------	-------

PA11 NYLONRØR I ESKE



90122111	PA-K 4/2 Blå 25m	25
90122113	PA-K 4/2 Blå 100m	100
90122123	PA-K 5/3 Blå 100m	100
90122131	PA-K 6/4 Blå 25m	25
90122133	PA-K 6/4 Blå 100m	100
90122141	PA-K 8/6 Blå 25m	25
90122142	PA-K 8/6 Blå 50m	50
90122151	PA-K 10/8 Blå 25m	25
90122161	PA-K 12/10 Blå 25m	25

PA11 NYLON SPIRALSLANGE



90220103	PAS-R 4/2-3m Grå	
90220106	PAS-R 4/2-6m Grå	
90220203	PAS-R 5/3-3m Grå	
90220206	PAS-R 5/3-6m Grå	
90220303	PAS-R 6/4-3m Grå	
90220306	PAS-R 6/4-6m Grå	
90220403	PAS-R 8/6-3m Grå	
90220406	PAS-R 8/6-6m Grå	
90220503	PAS-R 10/8-3m Grå	
90220506	PAS-R 10/8-6m Grå	
90220603	PAS-R 12/9-3m Grå	
90220606	PAS-R 12/9-6m Grå	

Med 2x100mm rette ender

SVEISEBESKYTTET PA11 RØR



90118332	PA11 WP 6/4 Blå 50m	50
90118342	PA11 WP 8/6 Blå 50m	50
90118352	PA11 WP 10/8 Blå 50m	50
90118362	PA11 WP 12/10 Blå 50m	50

RØRKUTTER



90198001	SVB 853 Rørkutter (stor)	
90198002	SVB 854 Rørkutter (standard)	
90198003	MW Rørkutter, plast	

Artikkelnr.	Benevnelse	Forp.
-------------	------------	-------

T-CLIPS

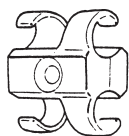

90197210	T-Clips 4-5mm svart	
90197230	T-Clips 6-7mm svart	
90197240	T-Clips 8-9mm svart	
90197250	T-Clips 10-11mm svart	
90197260	T-Clips 12-14mm svart	
90197280	T-Clips 15-17mm svart	

KLEMLISTER, BLÅ



90197110	KK 4-10 Blå klemlist	
90197130	KK 6-10 Blå klemlist	
90197140	KK 8-10 Blå klemlist	
90197150	KK 10-6 Blå klemlist	
90197160	KK 12-6 Blå klemlist	

MINIKULEVENTIL F.F.

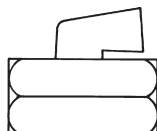

90421001	400 1/8 F.F Kuleventil	
90421002	400 1/4 F.F Kuleventil	
90421003	400 3/8 F.F Kuleventil	
90421004	400 1/2 F.F Kuleventil	

MINIKULEVENTIL M.F.

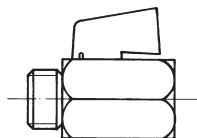

90422001	405 1/8 M.F Kuleventil	
90422002	405 1/4 M.F Kuleventil	
90422003	405 3/8 M.F Kuleventil	
90422004	405 1/2 M.F Kuleventil	

Artikkelnr.	Benevnelse	Forp.
-------------	------------	-------

MANOMETER

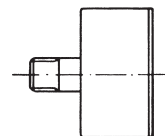

Anslutning bak

90311115	M40 1/8 0-4 Manometer	
90311135	M40 1/8 0-6 Manometer	
90311150	M40 1/8 0-10 Manometer	
90311160	M40 1/8 0-12 Manometer	
90312160	M50 1/8 0-12 Manometer	
90313160	M63 1/8 0-12 Manometer	

Anslutning ned

90321160	MR40 1/8 0-12 Manometer	
90323260	MR63 1/4 0-12 Manometer	

Panelmontert med bøyle

90331184	MP40 1/8 0-4 Panelm. bøyle	
90331190	MP40 1/8 0-10 Panelm. bøyle	
90333290	MP63 1/4 0-10 Panelm. bøyle	

Vakuumanometer

90341105	MV40 1/8 -1/0 Vakuummeter	
90343205	MV63 1/4 -1/0 Vakuummeter	
90361115	MPV40 1/8 -1/0 Vakuummeter bøyle	



SYLINDERE ISO 6432

Artikkelnr.	Benevnelse
-------------	------------

MINISYLINDER ISO 6432 DOBBELVIRKENDE

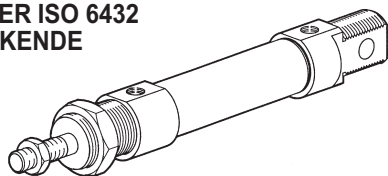

Ø 8 mm DE

Ø8 Dobbelvirkende, pakninger NBR: UTEN MAGNET	
1100080010XN	1100080010XN Sylinder
1100080025XN	1100080025XN Sylinder
1100080050XN	1100080050XN Sylinder
1100080080XN	1100080080XN Sylinder
1100080100XN	1100080100XN Sylinder
Ø8 Dobbelvirkende, pakninger NBR: MED MAGNET	
1120080010XN	1120080010XN Sylinder
1120080025XN	1120080025XN Sylinder
1120080050XN	1120080050XN Sylinder
1120080080XN	1120080080XN Sylinder
1120080100XN	1120080100XN Sylinder

Ø8 Dobbelvirkende, pakninger Polyuretan: UTEN MAGNET	
1100080010XP	1100080010XP Sylinder
1100080025XP	1100080025XP Sylinder
1100080050XP	1100080050XP Sylinder
1100080080XP	1100080080XP Sylinder
1100080100XP	1100080100XP Sylinder
Ø8 Dobbelvirkende, pakninger Polyuretan: MED MAGNET	
1120080010XP	1120080010XP Sylinder
1120080025XP	1120080025XP Sylinder
1120080050XP	1120080050XP Sylinder
1120080080XP	1120080080XP Sylinder
1120080100XP	1120080100XP Sylinder

Ø 10 mm DE

Ø10 Dobbelvirkende, pakninger NBR: UTEN MAGNET	
1100100010XN	1100100010XN Sylinder
1100100025XN	1100100025XN Sylinder
1100100050XN	1100100050XN Sylinder
1100100080XN	1100100080XN Sylinder
1100100100XN	1100100100XN Sylinder
Ø10 Dobbelvirkende, pakninger NBR: MED MAGNET	
1120100010XN	1120100010XN Sylinder
1120100025XN	1120100025XN Sylinder
1120100050XN	1120100050XN Sylinder
1120100080XN	1120100080XN Sylinder
1120100100XN	1120100100XN Sylinder

Ø10 Dobbelvirkende, pakninger Polyuretan: UTEN MAGNET	
1100100010XP	1100100010XP Sylinder
1100100025XP	1100100025XP Sylinder
1100100050XP	1100100050XP Sylinder
1100100080XP	1100100080XP Sylinder
1100100100XP	1100100100XP Sylinder
Ø10 Dobbelvirkende, pakninger Polyuretan: MED MAGNET	
1120100010XP	1120100010XP Sylinder
1120100025XP	1120100025XP Sylinder
1120100050XP	1120100050XP Sylinder
1120100080XP	1120100080XP Sylinder
1120100100XP	1120100100XP Sylinder

Artikkelnr.	Benevnelse
-------------	------------

Ø 12 mm DE

Ø12 Dobbelvirkende, pakninger NBR: UTEN MAGNET	
1100120010CN	1100120010CN Sylinder
1100120025CN	1100120025CN Sylinder
1100120050CN	1100120050CN Sylinder
1100120080CN	1100120080CN Sylinder
1100120100CN	1100120100CN Sylinder
1100120125CN	1100120125CN Sylinder
1100120160CN	1100120160CN Sylinder
1100120200CN	1100120200CN Sylinder
Ø12 Dobbelvirkende, pakninger NBR: MED MAGNET	
1120120010CN	1120120010CN Sylinder
1120120025CN	1120120025CN Sylinder
1120120050CN	1120120050CN Sylinder
1120120080CN	1120120080CN Sylinder
1120120100CN	1120120100CN Sylinder
1120120125CN	1120120125CN Sylinder
1120120160CN	1120120160CN Sylinder
1120120200CN	1120120200CN Sylinder

Ø12 Dobbelvirkende, pakninger Polyuretan: UTEN MAGNET	
1100120010CP	1100120010CP Sylinder
1100120025CP	1100120025CP Sylinder
1100120050CP	1100120050CP Sylinder
1100120080CP	1100120080CP Sylinder
1100120100CP	1100120100CP Sylinder
1100120125CP	1100120125CP Sylinder
1100120160CP	1100120160CP Sylinder
1100120200CP	1100120200CP Sylinder
Ø12 Dobbelvirkende, pakninger Polyuretan: MED MAGNET	
1120120010CP	1120120010CP Sylinder
1120120025CP	1120120025CP Sylinder
1120120050CP	1120120050CP Sylinder
1120120080CP	1120120080CP Sylinder
1120120100CP	1120120100CP Sylinder
1120120125CP	1120120125CP Sylinder
1120120160CP	1120120160CP Sylinder
1120120200CP	1120120200CP Sylinder

Ø 16 mm DE

Ø16 Dobbelvirkende, pakninger NBR: UTEN MAGNET	
1100160010CN	1100160010CN Sylinder
1100160025CN	1100160025CN Sylinder
1100160050CN	1100160050CN Sylinder
1100160080CN	1100160080CN Sylinder
1100160100CN	1100160100CN Sylinder
1100160125CN	1100160125CN Sylinder
1100160160CN	1100160160CN Sylinder
1100160200CN	1100160200CN Sylinder
Ø16 Dobbelvirkende, pakninger NBR: MED MAGNET	
1120160010CN	1120160010CN Sylinder
1120160025CN	1120160025CN Sylinder
1120160050CN	1120160050CN Sylinder
1120160080CN	1120160080CN Sylinder
1120160100CN	1120160100CN Sylinder
1120160125CN	1120160125CN Sylinder
1120160160CN	1120160160CN Sylinder
1120160200CN	1120160200CN Sylinder

Artikkelnr.	Benevnelse
-------------	------------

Ø 16 mm DE

Ø16 Dobbeltvirkende, pakninger Polyuretan: UTEN MAGNET	
1100160010CP	1100160010CP Sylinder
1100160025CP	1100160025CP Sylinder
1100160050CP	1100160050CP Sylinder
1100160080CP	1100160080CP Sylinder
1100160100CP	1100160100CP Sylinder
1100160125CP	1100160125CP Sylinder
1100160160CP	1100160160CP Sylinder
1100160200CP	1100160200CP Sylinder
Ø16 Dobbeltvirkende, pakninger Polyuretan: MED MAGNET	
1120160010CP	1120160010CP Sylinder
1120160025CP	1120160025CP Sylinder
1120160050CP	1120160050CP Sylinder
1120160080CP	1120160080CP Sylinder
1120160100CP	1120160100CP Sylinder
1120160125CP	1120160125CP Sylinder
1120160160CP	1120160160CP Sylinder
1120160200CP	1120160200CP Sylinder

Ø 20 mm DE

Ø20 Dobbeltvirkende, pakninger NBR: UTEN MAGNET	
1100200010CN	1100200010CN Sylinder
1100200025CN	1100200025CN Sylinder
1100200050CN	1100200050CN Sylinder
1100200080CN	1100200080CN Sylinder
1100200100CN	1100200100CN Sylinder
1100200125CN	1100200125CN Sylinder
1100200160CN	1100200160CN Sylinder
1100200200CN	1100200200CN Sylinder
1100200250CN	1100200250CN Sylinder
1100200320CN	1100200320CN Sylinder
Ø20 Dobbeltvirkende, pakninger NBR: MED MAGNET	
1120200010CN	1120200010CN Sylinder
1120200025CN	1120200025CN Sylinder
1120200050CN	1120200050CN Sylinder
1120200080CN	1120200080CN Sylinder
1120200100CN	1120200100CN Sylinder
1120200125CN	1120200125CN Sylinder
1120200160CN	1120200160CN Sylinder
1120200200CN	1120200200CN Sylinder
1120200250CN	1120200250CN Sylinder
1120200320CN	1120200320CN Sylinder

Ø20 Dobbeltvirkende, pakninger Polyuretan: UTEN MAGNET

1100200010CP	1100200010CP Sylinder
1100200025CP	1100200025CP Sylinder
1100200050CP	1100200050CP Sylinder
1100200080CP	1100200080CP Sylinder
1100200100CP	1100200100CP Sylinder
1100200125CP	1100200125CP Sylinder
1100200160CP	1100200160CP Sylinder
1100200200CP	1100200200CP Sylinder
1100200250CP	1100200250CP Sylinder
1100200320CP	1100200320CP Sylinder
Ø20 Dobbeltvirkende, pakninger Polyuretan: MED MAGNET	
1120200010CP	1120200010CP Sylinder
1120200025CP	1120200025CP Sylinder
1120200050CP	1120200050CP Sylinder
1120200080CP	1120200080CP Sylinder
1120200100CP	1120200100CP Sylinder
1120200125CP	1120200125CP Sylinder
1120200160CP	1120200160CP Sylinder
1120200200CP	1120200200CP Sylinder
1120200250CP	1120200250CP Sylinder
1120200320CP	1120200320CP Sylinder

Artikkelnr.	Benevnelse
-------------	------------

Ø 25 mm DE

Ø25 Dobbeltvirkende, pakninger NBR: UTEN MAGNET	
1100250010CN	1100250010CN Sylinder
1100250025CN	1100250025CN Sylinder
1100250050CN	1100250050CN Sylinder
1100250080CN	1100250080CN Sylinder
1100250100CN	1100250100CN Sylinder
1100250125CN	1100250125CN Sylinder
1100250160CN	1100250160CN Sylinder
1100250200CN	1100250200CN Sylinder
1100250250CN	1100250250CN Sylinder
1100250320CN	1100250320CN Sylinder
Ø25 Dobbeltvirkende, pakninger NBR: MED MAGNET	
1120250010CN	1120250010CN Sylinder
1120250025CN	1120250025CN Sylinder
1120250050CN	1120250050CN Sylinder
1120250080CN	1120250080CN Sylinder
1120250100CN	1120250100CN Sylinder
1120250125CN	1120250125CN Sylinder
1120250160CN	1120250160CN Sylinder
1120250200CN	1120250200CN Sylinder
1120250250CN	1120250250CN Sylinder
1120250320CN	1120250320CN Sylinder

Ø25 Dobbeltvirkende, pakninger Polyuretan: UTEN MAGNET

1100250010CP	1100250010CP Sylinder
1100250025CP	1100250025CP Sylinder
1100250050CP	1100250050CP Sylinder
1100250080CP	1100250080CP Sylinder
1100250100CP	1100250100CP Sylinder
1100250125CP	1100250125CP Sylinder
1100250160CP	1100250160CP Sylinder
1100250200CP	1100250200CP Sylinder
1100250250CP	1100250250CP Sylinder
1100250320CP	1100250320CP Sylinder
Ø25 Dobbeltvirkende, pakninger Polyuretan: MED MAGNET	
1120250010CP	1120250010CP Sylinder
1120250025CP	1120250025CP Sylinder
1120250050CP	1120250050CP Sylinder
1120250080CP	1120250080CP Sylinder
1120250100CP	1120250100CP Sylinder
1120250125CP	1120250125CP Sylinder
1120250160CP	1120250160CP Sylinder
1120250200CP	1120250200CP Sylinder
1120250250CP	1120250250CP Sylinder
1120250320CP	1120250320CP Sylinder

MINISYLINDER ISO 6432 ENKELVIRKENDE

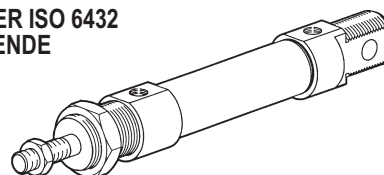

Ø 8 mm SE

Ø8 Enkelvirkende med magnet, pakninger NBR	
1110080010XN	1110080010XN Sylinder
1110080025XN	1110080025XN Sylinder
1110080050XN	1110080050XN Sylinder

Ø8 Enkelvirkende med magnet, pakninger Polyuretan	
1110080010XP	1110080010XP Sylinder
1110080025XP	1110080025XP Sylinder
1110080050XP	1110080050XP Sylinder



Artikkelnr.	Benevnelse
-------------	------------

Ø 10 mm SE

Ø10 Enkelvirkende med magnet, pakninger NBR	
1110100010XN	1110100010XN Sylinder
1110100025XN	1110100025XN Sylinder
1110100050XN	1110100050XN Sylinder

Ø10 Enkelvirkende med magnet, pakninger Polyuretan	
1110100010XP	1110100010XP Sylinder
1110100025XP	1110100025XP Sylinder
1110100050XP	1110100050XP Sylinder

Ø 12 mm SE

Ø12 Enkelvirkende med magnet, pakninger NBR	
1110120010CN	1110120010CN Sylinder
1110120025CN	1110120025CN Sylinder
1110120050CN	1110120050CN Sylinder

Ø12 Enkelvirkende med magnet, pakninger Polyuretan	
1110120010CP	1110120010CP Sylinder
1110120025CP	1110120025CP Sylinder
1110120050CP	1110120050CP Sylinder

Ø 16 mm SE

Ø16 Enkelvirkende med magnet, pakninger NBR	
1110160010CN	1110160010CN Sylinder
1110160025CN	1110160025CN Sylinder
1110160050CN	1110160050CN Sylinder

Ø16 Enkelvirkende med magnet, pakninger Polyuretan	
1110160010CP	1110160010CP Sylinder
1110160025CP	1110160025CP Sylinder
1110160050CP	1110160050CP Sylinder

Ø 20 mm SE

Ø20 Enkelvirkende med magnet, pakninger NBR	
1110200010CN	1110200010CN Sylinder
1110200025CN	1110200025CN Sylinder
1110200050CN	1110200050CN Sylinder

Ø20 Enkelvirkende med magnet, pakninger Polyuretan	
1110200010CP	1110200010CP Sylinder
1110200025CP	1110200025CP Sylinder
1110200050CP	1110200050CP Sylinder

Ø 25 mm SE

Ø25 Enkelvirkende med magnet, pakninger NBR	
1110250010CN	1110250010CN Sylinder
1110250025CN	1110250025CN Sylinder
1110250050CN	1110250050CN Sylinder

Ø25 Enkelvirkende med magnet, pakninger Polyuretan	
1110250010CP	1110250010CP Sylinder
1110250025CP	1110250025CP Sylinder
1110250050CP	1110250050CP Sylinder

Artikkelnr.	Benevnelse
-------------	------------

MINISYLINDER ISO 6432 MED ENDESLAGSBREMS

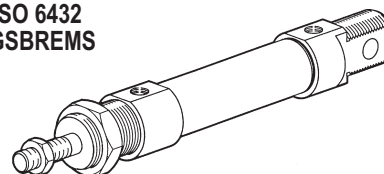

Ø 16 mm DEA

Ø16 Dobbeltvirkende, endeslagsbrems, pakninger NBR: UTEN MAGNET	
1090160010CN	1090160010CN Sylinder
1090160025CN	1090160025CN Sylinder
1090160050CN	1090160050CN Sylinder
1090160080CN	1090160080CN Sylinder
1090160100CN	1090160100CN Sylinder
1090160125CN	1090160125CN Sylinder
1090160160CN	1090160160CN Sylinder
1090160200CN	1090160200CN Sylinder
Ø16 Dobbeltvirkende, endeslagsbrems, pakninger NBR: MED MAGNET	
1130160010CN	1130160010CN Sylinder
1130160025CN	1130160025CN Sylinder
1130160050CN	1130160050CN Sylinder
1130160080CN	1130160080CN Sylinder
1130160100CN	1130160100CN Sylinder
1130160125CN	1130160125CN Sylinder
1130160160CN	1130160160CN Sylinder
1130160200CN	1130160200CN Sylinder

Ø16 Dobbeltvirkende, endeslagsbrems, pakninger Polyuretan: UTEN MAGNET	
1090160010CP	1090160010CP Sylinder
1090160025CP	1090160025CP Sylinder
1090160050CP	1090160050CP Sylinder
1090160080CP	1090160080CP Sylinder
1090160100CP	1090160100CP Sylinder
1090160125CP	1090160125CP Sylinder
1090160160CP	1090160160CP Sylinder
1090160200CP	1090160200CP Sylinder
Ø16 Dobbeltvirkende, endeslagsbrems, pakninger Polyuretan: MED MAGNET	
1130160010CP	1130160010CP Sylinder
1130160025CP	1130160025CP Sylinder
1130160050CP	1130160050CP Sylinder
1130160080CP	1130160080CP Sylinder
1130160100CP	1130160100CP Sylinder
1130160125CP	1130160125CP Sylinder
1130160160CP	1130160160CP Sylinder
1130160200CP	1130160200CP Sylinder



Artikkelnr.	Benevnelse
-------------	------------

Ø 20 mm DEA

Ø20 Dobbeltvirkende, endeslagsbrems, pakninger NBR: UTEN MAGNET	
1090200010CN	1090200010CN Sylinder
1090200025CN	1090200025CN Sylinder
1090200050CN	1090200050CN Sylinder
1090200080CN	1090200080CN Sylinder
1090200100CN	1090200100CN Sylinder
1090200125CN	1090200125CN Sylinder
1090200160CN	1090200160CN Sylinder
1090200200CN	1090200200CN Sylinder
1090200250CN	1090200250CN Sylinder
1090200320CN	1090200320CN Sylinder
Ø20 Dobbeltvirkende, endeslagsbrems, pakninger NBR: MED MAGNET	
1130200010CN	1130200010CN Sylinder
1130200025CN	1130200025CN Sylinder
1130200050CN	1130200050CN Sylinder
1130200080CN	1130200080CN Sylinder
1130200100CN	1130200100CN Sylinder
1130200125CN	1130200125CN Sylinder
1130200160CN	1130200160CN Sylinder
1130200200CN	1130200200CN Sylinder
1130200250CN	1130200250CN Sylinder
1130200320CN	1130200320CN Sylinder

Ø20 Dobbeltvirkende, endeslagsbrems, pakninger Polyuretan: UTEN MAGNET

1090200010CP	1090200010CP Sylinder
1090200025CP	1090200025CP Sylinder
1090200050CP	1090200050CP Sylinder
1090200080CP	1090200080CP Sylinder
1090200100CP	1090200100CP Sylinder
1090200125CP	1090200125CP Sylinder
1090200160CP	1090200160CP Sylinder
1090200200CP	1090200200CP Sylinder
1090200250CP	1090200250CP Sylinder
1090200320CP	1090200320CP Sylinder

Ø20 Dobbeltvirkende, endeslagsbrems, pakninger Polyuretan: MED MAGNET

1130200010CP	1130200010CP Sylinder
1130200025CP	1130200025CP Sylinder
1130200050CP	1130200050CP Sylinder
1130200080CP	1130200080CP Sylinder
1130200100CP	1130200100CP Sylinder
1130200125CP	1130200125CP Sylinder
1130200160CP	1130200160CP Sylinder
1130200200CP	1130200200CP Sylinder
1130200250CP	1130200250CP Sylinder
1130200320CP	1130200320CP Sylinder

Artikkelnr.	Benevnelse
-------------	------------

Ø 25 mm DEA

Ø25 Dobbeltvirkende, endeslagsbrems, pakninger NBR: UTEN MAGNET	
1090250010CN	1090250010CN Sylinder
1090250025CN	1090250025CN Sylinder
1090250050CN	1090250050CN Sylinder
1090250080CN	1090250080CN Sylinder
1090250100CN	1090250100CN Sylinder
1090250125CN	1090250125CN Sylinder
1090250160CN	1090250160CN Sylinder
1090250200CN	1090250200CN Sylinder
1090250250CN	1090250250CN Sylinder
1090250320CN	1090250320CN Sylinder
Ø25 Dobbeltvirkende, endeslagsbrems, pakninger NBR: MED MAGNET	
1130250010CN	1130250010CN Sylinder
1130250025CN	1130250025CN Sylinder
1130250050CN	1130250050CN Sylinder
1130250080CN	1130250080CN Sylinder
1130250100CN	1130250100CN Sylinder
1130250125CN	1130250125CN Sylinder
1130250160CN	1130250160CN Sylinder
1130250200CN	1130250200CN Sylinder
1130250250CN	1130250250CN Sylinder
1130250320CN	1130250320CN Sylinder

Ø25 Dobbeltvirkende, endeslagsbrems, pakninger Polyuretan: UTEN MAGNET

1090250010CP	1090250010CP Sylinder
1090250025CP	1090250025CP Sylinder
1090250050CP	1090250050CP Sylinder
1090250080CP	1090250080CP Sylinder
1090250100CP	1090250100CP Sylinder
1090250125CP	1090250125CP Sylinder
1090250160CP	1090250160CP Sylinder
1090250200CP	1090250200CP Sylinder
1090250250CP	1090250250CP Sylinder
1090250320CP	1090250320CP Sylinder

Ø25 Dobbeltvirkende, endeslagsbrems, pakninger Polyuretan: MED MAGNET

1130250010CP	1130250010CP Sylinder
1130250025CP	1130250025CP Sylinder
1130250050CP	1130250050CP Sylinder
1130250080CP	1130250080CP Sylinder
1130250100CP	1130250100CP Sylinder
1130250125CP	1130250125CP Sylinder
1130250160CP	1130250160CP Sylinder
1130250200CP	1130250200CP Sylinder
1130250250CP	1130250250CP Sylinder
1130250320CP	1130250320CP Sylinder

OBS!

MAX SLAGLENGDE	8	10	12	16	20	25
SE	50	50	50	50	50	50
DE	100	100	200	300	400	400
DEA	—	—	—	300	500	500

VIKTIG!

Ved montering av magnetføler på minisylinder med slaglengde kortere en eller like med det i tabellen, er det nødvendig å benytte føler for kortslagssylinder med påmontert adapterelement som følger med "sett" for kortslagssylindere.

DIAMETER SLAGLENGDE KORTERE ELLER LIKE MED:

Ø 8	25 mm
Ø 10	25 mm
Ø 12	25 mm
Ø 16	15 mm
Ø 20	15 mm
Ø 25	15 mm

Artikkelnr. Benevnelse

DS: U-PROFIL FOR NORMAL LAST LAV HASTIGHET

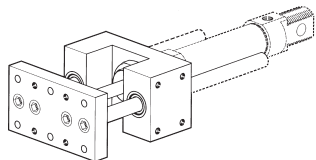

W0700121050	MWDS 012-0050 Lineærstyring
W0700121100	MWDS 012-0100 Lineærstyring
W0700121150	MWDS 012-0150 Lineærstyring
W0700121200	MWDS 012-0200 Lineærstyring
W0700121250	MWDS 012-0250 Lineærstyring
W0700161050	MWDS 016-0050 Lineærstyring
W0700161100	MWDS 016-0100 Lineærstyring
W0700161150	MWDS 016-0150 Lineærstyring
W0700161200	MWDS 016-0200 Lineærstyring
W0700161250	MWDS 016-0250 Lineærstyring
W0700201050	MWDS 020-0050 Lineærstyring
W0700201100	MWDS 020-0100 Lineærstyring
W0700201150	MWDS 020-0150 Lineærstyring
W0700201200	MWDS 020-0200 Lineærstyring
W0700201250	MWDS 020-0250 Lineærstyring
W0700251050	MWDS 025-0050 Lineærstyring
W0700251100	MWDS 025-0100 Lineærstyring
W0700251150	MWDS 025-0150 Lineærstyring
W0700251200	MWDS 025-0200 Lineærstyring
W0700251250	MWDS 025-0250 Lineærstyring

Artikkelnr. Benevnelse

DM: H-PROFIL FOR HØY HASTIGHET

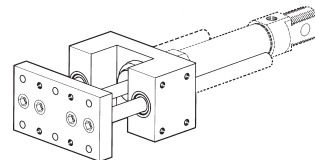

W0700123050	MWDM 012-0050 Lineærstyring
W0700123100	MWDM 012-0100 Lineærstyring
W0700123150	MWDM 012-0150 Lineærstyring
W0700123200	MWDM 012-0200 Lineærstyring
W0700123250	MWDM 012-0250 Lineærstyring
W0700163050	MWDM 016-0050 Lineærstyring
W0700163100	MWDM 016-0100 Lineærstyring
W0700163150	MWDM 016-0150 Lineærstyring
W0700163200	MWDM 016-0200 Lineærstyring
W0700163250	MWDM 016-0250 Lineærstyring
W0700203050	MWDM 020-0050 Lineærstyring
W0700203100	MWDM 020-0100 Lineærstyring
W0700203150	MWDM 020-0150 Lineærstyring
W0700203200	MWDM 020-0200 Lineærstyring
W0700203250	MWDM 020-0250 Lineærstyring
W0700253050	MWDM 025-0050 Lineærstyring
W0700253100	MWDM 025-0100 Lineærstyring
W0700253150	MWDM 025-0150 Lineærstyring
W0700253200	MWDM 025-0200 Lineærstyring
W0700253250	MWDM 025-0250 Lineærstyring

DH: H-PROFIL FOR TUNG LAST

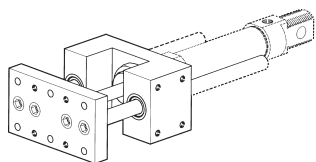

W0700122050	MWDH 012-0050 Lineærstyring
W0700122100	MWDH 012-0100 Lineærstyring
W0700122150	MWDH 012-0150 Lineærstyring
W0700122200	MWDH 012-0200 Lineærstyring
W0700122250	MWDH 012-0250 Lineærstyring
W0700162050	MWDH 016-0050 Lineærstyring
W0700162100	MWDH 016-0100 Lineærstyring
W0700162150	MWDH 016-0150 Lineærstyring
W0700162200	MWDH 016-0200 Lineærstyring
W0700162250	MWDH 016-0250 Lineærstyring
W0700202050	MWDH 020-0050 Lineærstyring
W0700202100	MWDH 020-0100 Lineærstyring
W0700202150	MWDH 020-0150 Lineærstyring
W0700202200	MWDH 020-0200 Lineærstyring
W0700202250	MWDH 020-0250 Lineærstyring
W0700252050	MWDH 025-0050 Lineærstyring
W0700252100	MWDH 025-0100 Lineærstyring
W0700252150	MWDH 025-0150 Lineærstyring
W0700252200	MWDH 025-0200 Lineærstyring
W0700252250	MWDH 025-0250 Lineærstyring

MEKANISK STEMPELSTANG LÅS FOR SYLINDER ISO 6432

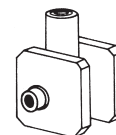

W5010001098	MA 7012/LD Stempelstang lås
W5010001099	MA 7016/LD Stempelstang lås
W5010001100	MA 7020/LD Stempelstang lås
W5010001101	MA 7025/LD Stempelstang lås

TILBEHØR



Artikkelnr.	Benevnelse
-------------	------------

FOTFESTE A

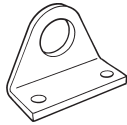

W0950080001	A-008/010 Fotfeste
W0950120001	A-012/016 Fotfeste
W0950200001	A-020/025 Fotfeste

FLENS C



W0950080002	C-008/010 Flens
W0950120002	C-012/016 Flens
W0950200002	C-020/025 Flens

SVINGFESTE BC

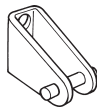

W0950080005	BC-008/010 Svingfeste
W0950120005	BC-012/016 Svingfeste
W0950200005	BC-020/025 Svingfeste

GAFFELFESTE GK - M

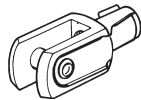

W0950080020	GK-M-008/010 Gaffelfeste
W0950120020	GK-M-012/016 Gaffelfeste
W0950200020	GK-M-020 Gaffelfeste

KULELEDDFESTE GA-M



W0950080025	GA-M-008/010 Kuleleddfeste
W0950120025	GA-M-012/016 Kuleleddfeste
W0950200025	GA-M-020 Kuleleddfeste

Artikkelnr.	Benevnelse
-------------	------------

STEMPELSTANGMUTTER



0950080011	DA-008/010 Stempelstangmutter
0950120011	DA-012/016 Stempelstangmutter
0950200011	DA-020 Stempelstangmutter

GAVLEMUTTER



0950080010	D-008 Gavlemutter
0950120010	D-012/016 Gavlemutter
0950200010	D-020/025 Gavlemutter

FESTEBØYLE FOR MAGNETFØLER SYLINDER ISO 6432



W0950000108	DXF12 D.08 Festeboyle
W0950000110	DXF14 D.10 Festeboyle
W0950000112	DXF16 D.12 Festeboyle
W0950000116	DXF20 D.16 Festeboyle
W0950000120	DXF24 D.20 Festeboyle
W0950000125	DXF29 D.25 Festeboyle

MAGNETFØLER

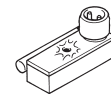
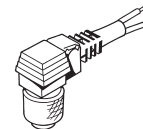

W0950000201	DSM2-C525 NO Reedkontakt
W0950000222	PNP DSM3-N225 Hallkontakt
W0950000232	NPN DSM3-M225 Hallkontakt

OBS! FOR GAFFELFESTE, KULELEDDFESTE OG STEMPELSTANGMUTTER Ø25, SE TILBEHØR FOR ISO 6431 SYLINDER Ø32



RUNDSYLINDERE

Artikelnr.	Benevnelse
------------	------------

RUNDSYLINDERE DOBBELTVIRKENDE Ø 32 ÷ Ø50

Ø 32 mm DE

Ø32 Dobbeltvirkende, pakninger Polyuretan: UTEN MAGNET	
1100320025CP	1100320025CP Sylinder
1100320050CP	1100320050CP Sylinder
1100320080CP	1100320080CP Sylinder
1100320100CP	1100320100CP Sylinder
1100320125CP	1100320125CP Sylinder
1100320160CP	1100320160CP Sylinder
1100320200CP	1100320200CP Sylinder
1100320250CP	1100320250CP Sylinder
1100320320CP	1100320320CP Sylinder
1100320400CP	1100320400CP Sylinder
1100320500CP	1100320500CP Sylinder
Ø32 Dobbeltvirkende, pakninger Polyuretan: MED MAGNET	
1120320025CP	1120320025CP Sylinder
1120320050CP	1120320050CP Sylinder
1120320080CP	1120320080CP Sylinder
1120320100CP	1120320100CP Sylinder
1120320125CP	1120320125CP Sylinder
1120320160CP	1120320160CP Sylinder
1120320200CP	1120320200CP Sylinder
1120320250CP	1120320250CP Sylinder
1120320320CP	1120320320CP Sylinder
1120320400CP	1120320400CP Sylinder
1120320500CP	1120320500CP Sylinder

Ø32 Dobbeltvirkende, pakninger NBR: UTEN MAGNET

1100320025CN	1100320025CN Sylinder
1100320050CN	1100320050CN Sylinder
1100320080CN	1100320080CN Sylinder
1100320100CN	1100320100CN Sylinder
1100320125CN	1100320125CN Sylinder
1100320160CN	1100320160CN Sylinder
1100320200CN	1100320200CN Sylinder
1100320250CN	1100320250CN Sylinder
1100320320CN	1100320320CN Sylinder
1100320400CN	1100320400CN Sylinder
1100320500CN	1100320500CN Sylinder

Ø32 Dobbeltvirkende, pakninger NBR: MED MAGNET

1120320025CN	1120320025CN Sylinder
1120320050CN	1120320050CN Sylinder
1120320080CN	1120320080CN Sylinder
1120320100CN	1120320100CN Sylinder
1120320125CN	1120320125CN Sylinder
1120320160CN	1120320160CN Sylinder
1120320200CN	1120320200CN Sylinder
1120320250CN	1120320250CN Sylinder
1120320320CN	1120320320CN Sylinder
1120320400CN	1120320400CN Sylinder
1120320500CN	1120320500CN Sylinder

Artikelnr.	Benevnelse
------------	------------

Ø 40 mm DE

Ø40 Dobbeltvirkende, pakninger Polyuretan: UTEN MAGNET	
1100400025CP	1100400025CP Sylinder
1100400050CP	1100400050CP Sylinder
1100400080CP	1100400080CP Sylinder
1100400100CP	1100400100CP Sylinder
1100400125CP	1100400125CP Sylinder
1100400160CP	1100400160CP Sylinder
1100400200CP	1100400200CP Sylinder
1100400250CP	1100400250CP Sylinder
1100400320CP	1100400320CP Sylinder
1100400400CP	1100400400CP Sylinder
1100400500CP	1100400500CP Sylinder
Ø40 Dobbeltvirkende, pakninger Polyuretan: MED MAGNET	
1120400025CP	1120400025CP Sylinder
1120400050CP	1120400050CP Sylinder
1120400080CP	1120400080CP Sylinder
1120400100CP	1120400100CP Sylinder
1120400125CP	1120400125CP Sylinder
1120400160CP	1120400160CP Sylinder
1120400200CP	1120400200CP Sylinder
1120400250CP	1120400250CP Sylinder
1120400320CP	1120400320CP Sylinder
1120400400CP	1120400400CP Sylinder
1120400500CP	1120400500CP Sylinder

Ø40 Dobbeltvirkende, pakninger NBR: UTEN MAGNET

1100400025CN	1100400025CN Sylinder
1100400050CN	1100400050CN Sylinder
1100400080CN	1100400080CN Sylinder
1100400100CN	1100400100CN Sylinder
1100400125CN	1100400125CN Sylinder
1100400160CN	1100400160CN Sylinder
1100400200CN	1100400200CN Sylinder
1100400250CN	1100400250CN Sylinder
1100400320CN	1100400320CN Sylinder
1100400400CN	1100400400CN Sylinder
1100400500CN	1100400500CN Sylinder

Ø40 Dobbeltvirkende, pakninger NBR: MED MAGNET

1120400025CN	1120400025CN Sylinder
1120400050CN	1120400050CN Sylinder
1120400080CN	1120400080CN Sylinder
1120400100CN	1120400100CN Sylinder
1120400125CN	1120400125CN Sylinder
1120400160CN	1120400160CN Sylinder
1120400200CN	1120400200CN Sylinder
1120400250CN	1120400250CN Sylinder
1120400320CN	1120400320CN Sylinder
1120400400CN	1120400400CN Sylinder
1120400500CN	1120400500CN Sylinder



Artikkelnr.	Benevnelse
-------------	------------

Ø 50 mm DE

Ø50 Dobbeltvirkende, pakninger Polyuretan: UTEN MAGNET

1100500025CP	1100500025CP Sylinder
1100500050CP	1100500050CP Sylinder
1100500080CP	1100500080CP Sylinder
1100500100CP	1100500100CP Sylinder
1100500125CP	1100500125CP Sylinder
1100500160CP	1100500160CP Sylinder
1100500200CP	1100500200CP Sylinder
1100500250CP	1100500250CP Sylinder
1100500320CP	1100500320CP Sylinder
1100500400CP	1100500400CP Sylinder
1100500500CP	1100500500CP Sylinder

Ø50 Dobbeltvirkende, pakninger Polyuretan: MED MAGNET

1120500025CP	1120500025CP Sylinder
1120500050CP	1120500050CP Sylinder
1120500080CP	1120500080CP Sylinder
1120500100CP	1120500100CP Sylinder
1120500125CP	1120500125CP Sylinder
1120500160CP	1120500160CP Sylinder
1120500200CP	1120500200CP Sylinder
1120500250CP	1120500250CP Sylinder
1120500320CP	1120500320CP Sylinder
1120500400CP	1120500400CP Sylinder
1120500500CP	1120500500CP Sylinder

Ø50 Dobbeltvirkende, pakninger NBR: UTEN MAGNET

1100500025CN	1100500025CN Sylinder
1100500050CN	1100500050CN Sylinder
1100500080CN	1100500080CN Sylinder
1100500100CN	1100500100CN Sylinder
1100500125CN	1100500125CN Sylinder
1100500160CN	1100500160CN Sylinder
1100500200CN	1100500200CN Sylinder
1100500250CN	1100500250CN Sylinder
1100500320CN	1100500320CN Sylinder
1100500400CN	1100500400CN Sylinder
1100500500CN	1100500500CN Sylinder

Ø50 Dobbeltvirkende, pakninger NBR: MED MAGNET

1120500025CN	1120500025CN Sylinder
1120500050CN	1120500050CN Sylinder
1120500080CN	1120500080CN Sylinder
1120500100CN	1120500100CN Sylinder
1120500125CN	1120500125CN Sylinder
1120500160CN	1120500160CN Sylinder
1120500200CN	1120500200CN Sylinder
1120500250CN	1120500250CN Sylinder
1120500320CN	1120500320CN Sylinder
1120500400CN	1120500400CN Sylinder
1120500500CN	1120500500CN Sylinder

Artikkelnr.	Benevnelse
-------------	------------

RUNDSYLINDERE Ø 32 ÷ Ø 50 DOBBELVIRKENDE MED ENDESLAGS- BREMS

Ø 32 mm DEA

Ø32 Dobbeltvirkende, endeslagsbrems, pakninger Polyuretan: UTEN MAGNET

1090320025CP	1090320025CP Sylinder
1090320050CP	1090320050CP Sylinder
1090320080CP	1090320080CP Sylinder
1090320100CP	1090320100CP Sylinder
1090320125CP	1090320125CP Sylinder
1090320160CP	1090320160CP Sylinder
1090320200CP	1090320200CP Sylinder
1090320250CP	1090320250CP Sylinder
1090320320CP	1090320320CP Sylinder
1090320400CP	1090320400CP Sylinder
1090320500CP	1090320500CP Sylinder

Ø32 Dobbeltvirkende, endeslagsbrems, pakninger Polyuretan: MED MAGNET

1130320025CP	1130320025CP Sylinder
1130320050CP	1130320050CP Sylinder
1130320080CP	1130320080CP Sylinder
1130320100CP	1130320100CP Sylinder
1130320125CP	1130320125CP Sylinder
1130320160CP	1130320160CP Sylinder
1130320200CP	1130320200CP Sylinder
1130320250CP	1130320250CP Sylinder
1130320320CP	1130320320CP Sylinder
1130320400CP	1130320400CP Sylinder
1130320500CP	1130320500CP Sylinder

Ø32 Dobbeltvirkende, endeslagsbrems, pakninger NBR: UTEN MAGNET

1090320025CN	1090320025CN Sylinder
1090320050CN	1090320050CN Sylinder
1090320080CN	1090320080CN Sylinder
1090320100CN	1090320100CN Sylinder
1090320125CN	1090320125CN Sylinder
1090320160CN	1090320160CN Sylinder
1090320200CN	1090320200CN Sylinder
1090320250CN	1090320250CN Sylinder
1090320320CN	1090320320CN Sylinder
1090320400CN	1090320400CN Sylinder
1090320500CN	1090320500CN Sylinder

Ø32 Dobbeltvirkende, endeslagsbrems, pakninger NBR: MED MAGNET

1130320025CN	1130320025CN Sylinder
1130320050CN	1130320050CN Sylinder
1130320080CN	1130320080CN Sylinder
1130320100CN	1130320100CN Sylinder
1130320125CN	1130320125CN Sylinder
1130320160CN	1130320160CN Sylinder
1130320200CN	1130320200CN Sylinder
1130320250CN	1130320250CN Sylinder
1130320320CN	1130320320CN Sylinder
1130320400CN	1130320400CN Sylinder
1130320500CN	1130320500CN Sylinder



Artikkelnr.	Benevnelse
-------------	------------

Ø 40 mm DEA

Ø40 Dobbeltvirkende, endeslagsbrems, pakninger Polyuretan: UTEN MAGNET	
1090400025CP	1090400025CP Sylinder
1090400050CP	1090400050CP Sylinder
1090400080CP	1090400080CP Sylinder
1090400100CP	1090400100CP Sylinder
1090400125CP	1090400125CP Sylinder
1090400160CP	1090400160CP Sylinder
1090400200CP	1090400200CP Sylinder
1090400250CP	1090400250CP Sylinder
1090400320CP	1090400320CP Sylinder
1090400400CP	1090400400CP Sylinder
1090400500CP	1090400500CP Sylinder
Ø40 Dobbeltvirkende, endeslagsbrems, pakninger Polyuretan: MED MAGNET	
1130400025CP	1130400025CP Sylinder
1130400050CP	1130400050CP Sylinder
1130400080CP	1130400080CP Sylinder
1130400100CP	1130400100CP Sylinder
1130400125CP	1130400125CP Sylinder
1130400160CP	1130400160CP Sylinder
1130400200CP	1130400200CP Sylinder
1130400250CP	1130400250CP Sylinder
1130400320CP	1130400320CP Sylinder
1130400400CP	1130400400CP Sylinder
1130400500CP	1130400500CP Sylinder

Ø40 Dobbeltvirkende, endeslagsbrems, pakninger NBR: UTEN MAGNET	
1090400025CN	1090400025CN Sylinder
1090400050CN	1090400050CN Sylinder
1090400080CN	1090400080CN Sylinder
1090400100CN	1090400100CN Sylinder
1090400125CN	1090400125CN Sylinder
1090400160CN	1090400160CN Sylinder
1090400200CN	1090400200CN Sylinder
1090400250CN	1090400250CN Sylinder
1090400320CN	1090400320CN Sylinder
1090400400CN	1090400400CN Sylinder
1090400500CN	1090400500CN Sylinder
Ø40 Dobbeltvirkende, endeslagsbrems, pakninger NBR: MED MAGNET	
1130400025CN	1130400025CN Sylinder
1130400050CN	1130400050CN Sylinder
1130400080CN	1130400080CN Sylinder
1130400100CN	1130400100CN Sylinder
1130400125CN	1130400125CN Sylinder
1130400160CN	1130400160CN Sylinder
1130400200CN	1130400200CN Sylinder
1130400250CN	1130400250CN Sylinder
1130400320CN	1130400320CN Sylinder
1130400400CN	1130400400CN Sylinder
1130400500CN	1130400500CN Sylinder

Artikkelnr.	Benevnelse
-------------	------------

Ø 50 mm DEA

Ø50 Dobbeltvirkende, endeslagsbrems, pakninger Polyuretan: UTEN MAGNET	
1090500025CP	1090500025CP Sylinder
1090500050CP	1090500050CP Sylinder
1090500080CP	1090500080CP Sylinder
1090500100CP	1090500100CP Sylinder
1090500125CP	1090500125CP Sylinder
1090500160CP	1090500160CP Sylinder
1090500200CP	1090500200CP Sylinder
1090500250CP	1090500250CP Sylinder
1090500320CP	1090500320CP Sylinder
1090500400CP	1090500400CP Sylinder
1090500500CP	1090500500CP Sylinder
Ø50 Dobbeltvirkende, endeslagsbrems, pakninger Polyuretan: MED MAGNET	
1130500025CP	1130500025CP Sylinder
1130500050CP	1130500050CP Sylinder
1130500080CP	1130500080CP Sylinder
1130500100CP	1130500100CP Sylinder
1130500125CP	1130500125CP Sylinder
1130500160CP	1130500160CP Sylinder
1130500200CP	1130500200CP Sylinder
1130500250CP	1130500250CP Sylinder
1130500320CP	1130500320CP Sylinder
1130500400CP	1130500400CP Sylinder
1130500500CP	1130500500CP Sylinder

Ø50 Dobbeltvirkende, endeslagsbrems, pakninger NBR: UTEN MAGNET	
1090500025CN	1090500025CN Sylinder
1090500050CN	1090500050CN Sylinder
1090500080CN	1090500080CN Sylinder
1090500100CN	1090500100CN Sylinder
1090500125CN	1090500125CN Sylinder
1090500160CN	1090500160CN Sylinder
1090500200CN	1090500200CN Sylinder
1090500250CN	1090500250CN Sylinder
1090500320CN	1090500320CN Sylinder
1090500400CN	1090500400CN Sylinder
1090500500CN	1090500500CN Sylinder
Ø50 Dobbeltvirkende, endeslagsbrems, pakninger NBR: MED MAGNET	
1130500025CN	1130500025CN Sylinder
1130500050CN	1130500050CN Sylinder
1130500080CN	1130500080CN Sylinder
1130500100CN	1130500100CN Sylinder
1130500125CN	1130500125CN Sylinder
1130500160CN	1130500160CN Sylinder
1130500200CN	1130500200CN Sylinder
1130500250CN	1130500250CN Sylinder
1130500320CN	1130500320CN Sylinder
1130500400CN	1130500400CN Sylinder
1130500500CN	1130500500CN Sylinder



Artikkelnr.	Benevnelse
-------------	------------

**RUNDSYLINDERE
Ø 32 ÷ Ø50
ENKELVIRKENDE**

Ø 32 mm SE

Ø32 Enkelvirkende, pakninger Polyuretan: MED MAGNET	
1110320025AP	1110320025AP Sylinder
1110320050AP	1110320050AP Sylinder
1110320080AP	1110320080AP Sylinder
1110320100AP	1110320100AP Sylinder
1110320125AP	1110320125AP Sylinder
1110320160AP	1110320160AP Sylinder
1110320200AP	1110320200AP Sylinder
1110320250AP	1110320250AP Sylinder
Ø32 Enkelvirkende, pakninger NBR: MED MAGNET	
1110320025AN	1110320025AN Sylinder
1110320050AN	1110320050AN Sylinder
1110320080AN	1110320080AN Sylinder
1110320100AN	1110320100AN Sylinder
1110320125AN	1110320125AN Sylinder
1110320160AN	1110320160AN Sylinder
1110320200AN	1110320200AN Sylinder
1110320250AN	1110320250AN Sylinder

Ø 40 mm SE

Ø40 Enkelvirkende, pakninger Polyuretan: MED MAGNET	
1110400025AP	1110400025AP Sylinder
1110400050AP	1110400050AP Sylinder
1110400080AP	1110400080AP Sylinder
1110400100AP	1110400100AP Sylinder
1110400125AP	1110400125AP Sylinder
1110400160AP	1110400160AP Sylinder
1110400200AP	1110400200AP Sylinder
1110400250AP	1110400250AP Sylinder
Ø40 Enkelvirkende, pakninger NBR: MED MAGNET	
1110400025AN	1110400025AN Sylinder
1110400050AN	1110400050AN Sylinder
1110400080AN	1110400080AN Sylinder
1110400100AN	1110400100AN Sylinder
1110400125AN	1110400125AN Sylinder
1110400160AN	1110400160AN Sylinder
1110400200AN	1110400200AN Sylinder
1110400250AN	1110400250AN Sylinder

Artikkelnr.	Benevnelse
-------------	------------

Ø 50 mm SE

Ø50 Enkelvirkende, pakninger Polyuretan: MED MAGNET	
1110500025AP	1110500025AP Sylinder
1110500050AP	1110500050AP Sylinder
1110500080AP	1110500080AP Sylinder
1110500100AP	1110500100AP Sylinder
1110500125AP	1110500125AP Sylinder
1110500160AP	1110500160AP Sylinder
1110500200AP	1110500200AP Sylinder
1110500250AP	1110500250AP Sylinder
Ø50 Enkelvirkende, pakninger NBR: MED MAGNET	
1110500025AN	1110500025AN Sylinder
1110500050AN	1110500050AN Sylinder
1110500080AN	1110500080AN Sylinder
1110500100AN	1110500100AN Sylinder
1110500125AN	1110500125AN Sylinder
1110500160AN	1110500160AN Sylinder
1110500200AN	1110500200AN Sylinder
1110500250AN	1110500250AN Sylinder



TILBEHØR RUNDSYLINDERE

Artikkelnr.	Benevnelse
-------------	------------

FOTFESTE AC

W0950320002	AC-032 Fotfeste
W0950400002	AC-040 Fotfeste
W0950500002	AC-050 Fotfeste

SVINGFESTE BC

W0950320005	BC-032 Svingfeste
W0950400005	BC-040 Svingfeste
W0950500005	BC-050 Svingfeste

GAVLEMUTTER G

W0950320010	G-032 Gavlemutter
W0950400010	G-040 Gavlemutter
W0950500010	G-050 Gavlemutter

GAFFELFESTE GK-M

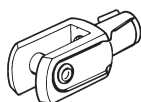

W0950322020	GK-M-032/025 Gaffelfeste
W0950402020	GK-M-040 Gaffelfeste
W0950502020	GK-M-050/063 Gaffelfeste

Artikkelnr.	Benevnelse
-------------	------------

KULELEDDFESTE GA-M



W0950322025	GA-M-032/025 Kuleleddfeste
W0950402025	GA-M-040 Kuleleddfeste
W0950502025	GA-M-050/063 Kuleleddfeste

VRIBAR STEMPELSTANGSENDE GA-K

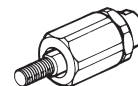

W0950322030	GA-K-032 Stempelstangsende
W0950402030	GA-K-040 Stempelstangsende
W0950502030	GA-K-050/063 Stempelstangsende

MAGNETFØLER

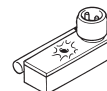
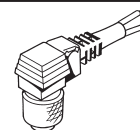

W0950000201	DSM2-C525 NO Reedkontakt
W0950000222	PNP DSM3-N225 Hallkontakt
W0950000232	NPN DSM3-M225 Hallkontakt

FESTEBØYLE FOR MAGNETFØLER



W0950000132	DXF36 D.32 Festeboyle
W0950000140	DXF45 D.40 Festeboyle
W0950000150	DXF52 D.50 Festeboyle

SYLINDERE ISO 6431



Artikkelnr. Benevnelse

SYLINDERE ISO 6431 Ø 32 ÷ Ø125

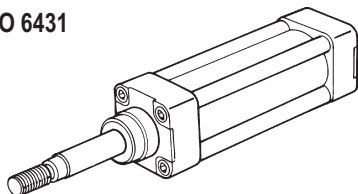

Ø 32 mm DE

Ø32 Pakninger NBR: UTEN MAGNET

1200320025CN	1200320025CN	Sylinder
1200320050CN	1200320050CN	Sylinder
1200320075CN	1200320075CN	Sylinder
1200320080CN	1200320080CN	Sylinder
1200320100CN	1200320100CN	Sylinder
1200320125CN	1200320125CN	Sylinder
1200320150CN	1200320150CN	Sylinder
1200320160CN	1200320160CN	Sylinder
1200320200CN	1200320200CN	Sylinder
1200320250CN	1200320250CN	Sylinder
1200320300CN	1200320300CN	Sylinder
1200320320CN	1200320320CN	Sylinder
1200320350CN	1200320350CN	Sylinder
1200320400CN	1200320400CN	Sylinder
1200320450CN	1200320450CN	Sylinder
1200320500CN	1200320500CN	Sylinder
1200320550CN	1200320550CN	Sylinder
1200320600CN	1200320600CN	Sylinder
1200320650CN	1200320650CN	Sylinder
1200320700CN	1200320700CN	Sylinder
1200320750CN	1200320750CN	Sylinder
1200320800CN	1200320800CN	Sylinder
1200320850CN	1200320850CN	Sylinder
1200320900CN	1200320900CN	Sylinder
1200320950CN	1200320950CN	Sylinder
1200321000AN	1200321000AN	Sylinder

Ø32 Pakninger NBR: MED MAGNET

1210320025CN	1210320025CN	Sylinder
1210320050CN	1210320050CN	Sylinder
1210320075CN	1210320075CN	Sylinder
1210320080CN	1210320080CN	Sylinder
1210320100CN	1210320100CN	Sylinder
1210320125CN	1210320125CN	Sylinder
1210320150CN	1210320150CN	Sylinder
1210320160CN	1210320160CN	Sylinder
1210320200CN	1210320200CN	Sylinder
1210320250CN	1210320250CN	Sylinder
1210320300CN	1210320300CN	Sylinder
1210320320CN	1210320320CN	Sylinder
1210320350CN	1210320350CN	Sylinder
1210320400CN	1210320400CN	Sylinder
1210320450CN	1210320450CN	Sylinder
1210320500CN	1210320500CN	Sylinder
1210320550CN	1210320550CN	Sylinder
1210320600CN	1210320600CN	Sylinder
1210320650CN	1210320650CN	Sylinder
1210320700CN	1210320700CN	Sylinder
1210320750CN	1210320750CN	Sylinder
1210320800CN	1210320800CN	Sylinder
1210320850CN	1210320850CN	Sylinder
1210320900CN	1210320900CN	Sylinder
1210320950CN	1210320950CN	Sylinder
1210321000AN	1210321000AN	Sylinder

Artikkelnr. Benevnelse

Ø32 Pakninger Polyuretan: UTEN MAGNET

1200320025CP	1200320025CP	Sylinder
1200320050CP	1200320050CP	Sylinder
1200320075CP	1200320075CP	Sylinder
1200320080CP	1200320080CP	Sylinder
1200320100CP	1200320100CP	Sylinder
1200320125CP	1200320125CP	Sylinder
1200320150CP	1200320150CP	Sylinder
1200320160CP	1200320160CP	Sylinder
1200320200CP	1200320200CP	Sylinder
1200320250CP	1200320250CP	Sylinder
1200320300CP	1200320300CP	Sylinder
1200320320CP	1200320320CP	Sylinder
1200320350CP	1200320350CP	Sylinder
1200320400CP	1200320400CP	Sylinder
1200320450CP	1200320450CP	Sylinder
1200320500CP	1200320500CP	Sylinder
1200320550CP	1200320550CP	Sylinder
1200320600CP	1200320600CP	Sylinder
1200320650CP	1200320650CP	Sylinder
1200320700CP	1200320700CP	Sylinder
1200320750CP	1200320750CP	Sylinder
1200320800CP	1200320800CP	Sylinder
1200320850CP	1200320850CP	Sylinder
1200320900CP	1200320900CP	Sylinder
1200320950CP	1200320950CP	Sylinder
1200321000AP	1200321000AP	Sylinder

Ø32 Pakninger Polyuretan: MED MAGNET

1210320025CP	1210320025CP	Sylinder
1210320050CP	1210320050CP	Sylinder
1210320075CP	1210320075CP	Sylinder
1210320080CP	1210320080CP	Sylinder
1210320100CP	1210320100CP	Sylinder
1210320125CP	1210320125CP	Sylinder
1210320150CP	1210320150CP	Sylinder
1210320160CP	1210320160CP	Sylinder
1210320200CP	1210320200CP	Sylinder
1210320250CP	1210320250CP	Sylinder
1210320300CP	1210320300CP	Sylinder
1210320320CP	1210320320CP	Sylinder
1210320350CP	1210320350CP	Sylinder
1210320400CP	1210320400CP	Sylinder
1210320450CP	1210320450CP	Sylinder
1210320500CP	1210320500CP	Sylinder
1210320550CP	1210320550CP	Sylinder
1210320600CP	1210320600CP	Sylinder
1210320650CP	1210320650CP	Sylinder
1210320700CP	1210320700CP	Sylinder
1210320750CP	1210320750CP	Sylinder
1210320800CP	1210320800CP	Sylinder
1210320850CP	1210320850CP	Sylinder
1210320900CP	1210320900CP	Sylinder
1210320950CP	1210320950CP	Sylinder
1210321000AP	1210321000AP	Sylinder



Artikkelnr.	Benevnelse
-------------	------------

Ø 40 mm DE

Ø40 Pakninger NBR: UTEN MAGNET	
1200400025CN	1200400025CN Syylinder
1200400050CN	1200400050CN Syylinder
1200400075CN	1200400075CN Syylinder
1200400080CN	1200400080CN Syylinder
1200400100CN	1200400100CN Syylinder
1200400125CN	1210400125CN Syylinder
1200400150CN	1200400150CN Syylinder
1200400160CN	1200400160CN Syylinder
1200400200CN	1200400200CN Syylinder
1200400250CN	1200400250CN Syylinder
1200400300CN	1200400300CN Syylinder
1200400320CN	1200400320CN Syylinder
1200400350CN	1200400350CN Syylinder
1200400400CN	1200400400CN Syylinder
1200400450CN	1200400450CN Syylinder
1200400500CN	1200400500CN Syylinder
1200400550CN	1200400550CN Syylinder
1200400600CN	1200400600CN Syylinder
1200400650CN	1200400650CN Syylinder
1200400700CN	1200400700CN Syylinder
1200400750CN	1200400750CN Syylinder
1200400800CN	1200400800CN Syylinder
1200400850CN	1200400850CN Syylinder
1200400900CN	1200400900CN Syylinder
1200400950CN	1200400950CN Syylinder
1200401000AN	1200401000AN Syylinder
Ø40 Pakninger NBR: MED MAGNET	
1210400025CN	1210400025CN Syylinder
1210400050CN	1210400050CN Syylinder
1210400075CN	1210400075CN Syylinder
1210400080CN	1210400080CN Syylinder
1210400100CN	1210400100CN Syylinder
1210400125CN	1210400125CN Syylinder
1210400150CN	1210400150CN Syylinder
1210400160CN	1210400160CN Syylinder
1210400200CN	1210400200CN Syylinder
1210400250CN	1210400250CN Syylinder
1210400300CN	1210400300CN Syylinder
1210400320CN	1210400320CN Syylinder
1210400350CN	1210400350CN Syylinder
1210400400CN	1210400400CN Syylinder
1210400450CN	1210400450CN Syylinder
1210400500CN	1210400500CN Syylinder
1210400550CN	1210400550CN Syylinder
1210400600CN	1210400600CN Syylinder
1210400650CN	1210400650CN Syylinder
1210400700CN	1210400700CN Syylinder
1210400750CN	1210400750CN Syylinder
1210400800CN	1210400800CN Syylinder
1210400850CN	1210400850CN Syylinder
1210400900CN	1210400900CN Syylinder
1210400950CN	1210400950CN Syylinder
1210401000AN	1210401000AN Syylinder

Artikkelnr.	Benevnelse
-------------	------------

Ø40 Pakninger Polyuretan: UTEN MAGNET	
1200400025CP	1200400025CP Syylinder
1200400050CP	1200400050CP Syylinder
1200400075CP	1200400075CP Syylinder
1200400080CP	1200400080CP Syylinder
1200400100CP	1200400100CP Syylinder
1200400125CP	1200400125CP Syylinder
1200400150CP	1200400150CP Syylinder
1200400160CP	1200400160CP Syylinder
1200400200CP	1200400200CP Syylinder
1200400250CP	1200400250CP Syylinder
1200400300CP	1200400300CP Syylinder
1200400320CP	1200400320CP Syylinder
1200400350CP	1200400350CP Syylinder
1200400400CP	1200400400CP Syylinder
1200400450CP	1200400450CP Syylinder
1200400500CP	1200400500CP Syylinder
1200400550CP	1200400550CP Syylinder
1200400600CP	1200400600CP Syylinder
1200400650CP	1200400650CP Syylinder
1200400700CP	1200400700CP Syylinder
1200400750CP	1200400750CP Syylinder
1200400800CP	1200400800CP Syylinder
1200400850CP	1200400850CP Syylinder
1200400900CP	1200400900CP Syylinder
1200400950CP	1200400950CP Syylinder
1200401000AP	1200401000AP Syylinder
Ø40 Pakninger Polyuretan: MED MAGNET	
1210400025CP	1210400025CP Syylinder
1210400050CP	1210400050CP Syylinder
1210400075CP	1210400075CP Syylinder
1210400080CP	1210400080CP Syylinder
1210400100CP	1210400100CP Syylinder
1210400125CP	1210400125CP Syylinder
1210400150CP	1210400150CP Syylinder
1210400160CP	1210400160CP Syylinder
1210400200CP	1210400200CP Syylinder
1210400250CP	1210400250CP Syylinder
1210400300CP	1210400300CP Syylinder
1210400320CP	1210400320CP Syylinder
1210400350CP	1210400350CP Syylinder
1210400400CP	1210400400CP Syylinder
1210400450CP	1210400450CP Syylinder
1210400500CP	1210400500CP Syylinder
1210400550CP	1210400550CP Syylinder
1210400600CP	1210400600CP Syylinder
1210400650CP	1210400650CP Syylinder
1210400700CP	1210400700CP Syylinder
1210400750CP	1210400750CP Syylinder
1210400800CP	1210400800CP Syylinder
1210400850CP	1210400850CP Syylinder
1210400900CP	1210400900CP Syylinder
1210400950CP	1210400950CP Syylinder
1210401000AP	1210401000AP Syylinder



Artikkelnr.	Benevnelse
-------------	------------

Ø 50 mm DE

Ø50 Pakninger NBR: UTEN MAGNET	
1200500025CN	1200500025CN Sylinder
1200500050CN	1200500050CN Sylinder
1200500075CN	1200500075CN Sylinder
1200500080CN	1200500080CN Sylinder
1200500100CN	1200500100CN Sylinder
1200500125CN	1200500125CN Sylinder
1200500150CN	1200500150CN Sylinder
1200500160CN	1200500160CN Sylinder
1200500200CN	1200500200CN Sylinder
1200500250CN	1200500250CN Sylinder
1200500300CN	1200500300CN Sylinder
1200500320CN	1200500320CN Sylinder
1200500350CN	1200500350CN Sylinder
1200500400CN	1200500400CN Sylinder
1200500450CN	1210500450CN Sylinder
1200500500CN	1200500500CN Sylinder
1200500550CN	1200500550CN Sylinder
1200500600CN	1200500600CN Sylinder
1200500650CN	1200500650CN Sylinder
1200500700CN	1200500700CN Sylinder
1200500750CN	1200500750CN Sylinder
1200500800CN	1200500800CN Sylinder
1200500850CN	1200500850CN Sylinder
1200500900CN	1200500900CN Sylinder
1200500950CN	1200500950CN Sylinder
1200501000AN	1200501000AN Sylinder
Ø50 Pakninger NBR: MED MAGNET	
1210500025CN	1210500025CN Sylinder
1210500050CN	1210500050CN Sylinder
1210500075CN	1210500075CN Sylinder
1210500080CN	1210500080CN Sylinder
1210500100CN	1210500100CN Sylinder
1210500125CN	1210500125CN Sylinder
1210500150CN	1210500150CN Sylinder
1210500160CN	1210500160CN Sylinder
1210500200CN	1210500200CN Sylinder
1210500250CN	1210500250CN Sylinder
1210500300CN	1210500300CN Sylinder
1210500320CN	1210500320CN Sylinder
1210500350CN	1210500350CN Sylinder
1210500400CN	1210500400CN Sylinder
1210500450CN	1210500450CN Sylinder
1210500500CN	1210500500CN Sylinder
1210500550CN	1210500550CN Sylinder
1210500600CN	1210500600CN Sylinder
1210500650CN	1210500650CN Sylinder
1210500700CN	1210500700CN Sylinder
1210500750CN	1210500750CN Sylinder
1210500800CN	1210500800CN Sylinder
1210500850CN	1210500850CN Sylinder
1210500900CN	1210500900CN Sylinder
1210500950CN	1210500950CN Sylinder
1210501000AN	1210501000AN Sylinder

Artikkelnr.	Benevnelse
-------------	------------

Ø50 Pakninger Polyuretan: UTEN MAGNET	
1200500025CP	1200500025CP Sylinder
1200500050CP	1200500050CP Sylinder
1200500075CP	1200500075CP Sylinder
1200500080CP	1200500080CP Sylinder
1200500100CP	1200500100CP Sylinder
1200500125CP	1200500125CP Sylinder
1200500150CP	1200500150CP Sylinder
1200500160CP	1200500160CP Sylinder
1200500200CP	1200500200CP Sylinder
1200500250CP	1200500250CP Sylinder
1200500300CP	1200500300CP Sylinder
1200500320CP	1200500320CP Sylinder
1200500350CP	1200500350CP Sylinder
1200500400CP	1200500400CP Sylinder
1200500450CP	1200500450CP Sylinder
1200500500CP	1200500500CP Sylinder
1200500550CP	1200500550CP Sylinder
1200500600CP	1200500600CP Sylinder
1200500650CP	1200500650CP Sylinder
1200500700CP	1200500700CP Sylinder
1200500750CP	1200500750CP Sylinder
1200500800CP	1200500800CP Sylinder
1200500850CP	1200500850CP Sylinder
1200500900CP	1200500900CP Sylinder
1200500950CP	1200500950CP Sylinder
1200501000AP	1200501000AP Sylinder
Ø50 Pakninger Polyuretan: MED MAGNET	
1210500025CP	1210500025CP Sylinder
1210500050CP	1210500050CP Sylinder
1210500075CP	1210500075CP Sylinder
1210500080CP	1210500080CP Sylinder
1210500100CP	1210500100CP Sylinder
1210500125CP	1210500125CP Sylinder
1210500150CP	1210500150CP Sylinder
1210500160CP	1210500160CP Sylinder
1210500200CP	1210500200CP Sylinder
1210500250CP	1210500250CP Sylinder
1210500300CP	1210500300CP Sylinder
1210500320CP	1210500320CP Sylinder
1210500350CP	1210500350CP Sylinder
1210500400CP	1210500400CP Sylinder
1210500450CP	1210500450CP Sylinder
1210500500CP	1210500500CP Sylinder
1210500550CP	1210500550CP Sylinder
1210500600CP	1210500600CP Sylinder
1210500650CP	1210500650CP Sylinder
1210500700CP	1210500700CP Sylinder
1210500750CP	1210500750CP Sylinder
1210500800CP	1210500800CP Sylinder
1210500850CP	1210500850CP Sylinder
1210500900CP	1210500900CP Sylinder
1210500950CP	1210500950CP Sylinder
1210501000AP	1210501000AP Sylinder



Artikkelnr.	Benevnelse
-------------	------------

Ø 63 mm DE

Ø63 Pakninger NBR: UTEN MAGNET	
1200630025CN	1200630025CN Sylinder
1200630050CN	1200630050CN Sylinder
1200630075CN	1200630075CN Sylinder
1200630080CN	1200630080CN Sylinder
1200630100CN	1200630100CN Sylinder
1200630125CN	1200630125CN Sylinder
1200630150CN	1200630150CN Sylinder
1200630160CN	1200630160CN Sylinder
1200630200CN	1200630200CN Sylinder
1200630250CN	1200630250CN Sylinder
1200630300CN	1200630300CN Sylinder
1200630320CN	1200630320CN Sylinder
1200630350CN	1200630350CN Sylinder
1200630400CN	1200630400CN Sylinder
1200630450CN	1200630450CN Sylinder
1200630500CN	1200630500CN Sylinder
1200630550CN	1200630550CN Sylinder
1200630600CN	1200630600CN Sylinder
1200630650CN	1200630650CN Sylinder
1200630700CN	1200630700CN Sylinder
1200630750CN	1200630750CN Sylinder
1200630800CN	1200630800CN Sylinder
1200630850CN	1200630850CN Sylinder
1200630900CN	1200630900CN Sylinder
1200630950CN	1200630950CN Sylinder
1200631000AN	1200631000AN Sylinder
Ø63 Pakninger NBR: MED MAGNET	
1210630025CN	1210630025CN Sylinder
1210630050CN	1210630050CN Sylinder
1210630075CN	1210630075CN Sylinder
1210630080CN	1210630080CN Sylinder
1210630100CN	1210630100CN Sylinder
1210630125CN	1210630125CN Sylinder
1210630150CN	1210630150CN Sylinder
1210630160CN	1210630160CN Sylinder
1210630200CN	1210630200CN Sylinder
1210630250CN	1210630250CN Sylinder
1210630300CN	1210630300CN Sylinder
1210630320CN	1210630320CN Sylinder
1210630350CN	1210630350CN Sylinder
1210630400CN	1210630400CN Sylinder
1210630450CN	1210630450CN Sylinder
1210630500CN	1210630500CN Sylinder
1210630550CN	1210630550CN Sylinder
1210630600CN	1210630600CN Sylinder
1210630650CN	1210630650CN Sylinder
1210630700CN	1210630700CN Sylinder
1210630750CN	1210630750CN Sylinder
1210630800CN	1210630800CN Sylinder
1210630850CN	1210630850CN Sylinder
1210630900CN	1210630900CN Sylinder
1210630950CN	1210630950CN Sylinder
1210631000AN	1210631000AN Sylinder

Artikkelnr.	Benevnelse
-------------	------------

Ø63 Pakninger Polyuretan: UTEN MAGNET	
1200630025CP	1200630025CP Sylinder
1200630050CP	1200630050CP Sylinder
1200630075CP	1200630075CP Sylinder
1200630080CP	1200630080CP Sylinder
1200630100CP	1200630100CP Sylinder
1200630125CP	1200630125CP Sylinder
1200630150CP	1200630150CP Sylinder
1200630160CP	1200630160CP Sylinder
1200630200CP	1200630200CP Sylinder
1200630250CP	1200630250CP Sylinder
1200630300CP	1200630300CP Sylinder
1200630320CP	1200630320CP Sylinder
1200630350CP	1200630350CP Sylinder
1200630400CP	1200630400CP Sylinder
1200630450CP	1200630450CP Sylinder
1200630500CP	1200630500CP Sylinder
1200630550CP	1200630550CP Sylinder
1200630600CP	1200630600CP Sylinder
1200630650CP	1200630650CP Sylinder
1200630700CP	1200630700CP Sylinder
1200630750CP	1200630750CP Sylinder
1200630800CP	1200630800CP Sylinder
1200630850CP	1200630850CP Sylinder
1200630900CP	1200630900CP Sylinder
1200630950CP	1200630950CP Sylinder
1200631000AP	1200631000AP Sylinder
Ø63 Pakninger Polyuretan: MED MAGNET	
1210630025CP	1210630025CP Sylinder
1210630050CP	1210630050CP Sylinder
1210630075CP	1210630075CP Sylinder
1210630080CP	1210630080CP Sylinder
1210630100CP	1210630100CP Sylinder
1210630125CP	1210630125CP Sylinder
1210630150CP	1210630150CP Sylinder
1210630160CP	1210630160CP Sylinder
1210630200CP	1210630200CP Sylinder
1210630250CP	1210630250CP Sylinder
1210630300CP	1210630300CP Sylinder
1210630320CP	1210630320CP Sylinder
1210630350CP	1210630350CP Sylinder
1210630400CP	1210630400CP Sylinder
1210630450CP	1210630450CP Sylinder
1210630500CP	1210630500CP Sylinder
1210630550CP	1210630550CP Sylinder
1210630600CP	1210630600CP Sylinder
1210630650CP	1210630650CP Sylinder
1210630700CP	1210630700CP Sylinder
1210630750CP	1210630750CP Sylinder
1210630800CP	1210630800CP Sylinder
1210630850CP	1210630850CP Sylinder
1210630900CP	1210630900CP Sylinder
1210630950CP	1210630950CP Sylinder
1210631000AP	1210631000AP Sylinder



Artikkelnr.	Benevnelse
-------------	------------

Ø 80 mm DE

Ø80 Pakninger NBR: UTEN MAGNET

1200800025AN	1200800025AN Sylinder
1200800050AN	1200800050AN Sylinder
1200800075AN	1200800075AN Sylinder
1200800080AN	1200800080AN Sylinder
1200800100AN	1200800100AN Sylinder
1200800125AN	1200800125AN Sylinder
1200800150AN	1200800150AN Sylinder
1200800160AN	1200800160AN Sylinder
1200800200AN	1200800200AN Sylinder
1200800250AN	1200800250AN Sylinder
1200800300AN	1200800300AN Sylinder
1200800320AN	1200800320AN Sylinder
1200800350AN	1200800350AN Sylinder
1200800400AN	1200800400AN Sylinder
1200800450AN	1200800450AN Sylinder
1200800500AN	1200800500AN Sylinder
1200800550AN	1200800550AN Sylinder
1200800600AN	1200800600AN Sylinder
1200800650AN	1200800650AN Sylinder
1200800700AN	1200800700AN Sylinder
1200800750AN	1200800750AN Sylinder
1200800800AN	1200800800AN Sylinder
1200800850AN	1200800850AN Sylinder
1200800900AN	1200800900AN Sylinder
1200800950AN	1200800950AN Sylinder
1200801000AN	1200801000AN Sylinder

Ø80 Pakninger NBR: MED MAGNET

1210800025AN	1210800025AN Sylinder
1210800050AN	1210800050AN Sylinder
1210800075AN	1210800075AN Sylinder
1210800080AN	1210800080AN Sylinder
1210800100AN	1210800100AN Sylinder
1210800125AN	1210800125AN Sylinder
1210800150AN	1210800150AN Sylinder
1210800160AN	1210800160AN Sylinder
1210800200AN	1210800200AN Sylinder
1210800250AN	1210800250AN Sylinder
1210800300AN	1210800300AN Sylinder
1210800320AN	1210800320AN Sylinder
1210800350AN	1210800350AN Sylinder
1210800400AN	1210800400AN Sylinder
1210800450AN	1210800450AN Sylinder
1210800500AN	1210800500AN Sylinder
1210800550AN	1210800550AN Sylinder
1210800600AN	1210800600AN Sylinder
1210800650AN	1210800650AN Sylinder
1210800700AN	1210800700AN Sylinder
1210800750AN	1210800750AN Sylinder
1210800800AN	1210800800AN Sylinder
1210800850AN	1210800850AN Sylinder
1210800900AN	1210800900AN Sylinder
1210800950AN	1210800950AN Sylinder
1210801000AN	1210801000AN Sylinder

Artikkelnr.	Benevnelse
-------------	------------

Ø80 Pakninger Polyuretan: UTEN MAGNET

1200800025AP	1200800025AP Sylinder
1200800050AP	1200800050AP Sylinder
1200800075AP	1200800075AP Sylinder
1200800080AP	1200800080AP Sylinder
1200800100AP	1200800100AP Sylinder
1200800125AP	1200800125AP Sylinder
1200800150AP	1200800150AP Sylinder
1200800160AP	1200800160AP Sylinder
1200800200AP	1200800200AP Sylinder
1200800250AP	1200800250AP Sylinder
1200800300AP	1200800300AP Sylinder
1200800320AP	1200800320AP Sylinder
1200800350AP	1200800350AP Sylinder
1200800400AP	1200800400AP Sylinder
1200800450AP	1200800450AP Sylinder
1200800500AP	1200800500AP Sylinder
1200800550AP	1200800550AP Sylinder
1200800600AP	1200800600AP Sylinder
1200800650AP	1200800650AP Sylinder
1200800700AP	1200800700AP Sylinder
1200800750AP	1200800750AP Sylinder
1200800800AP	1200800800AP Sylinder
1200800850AP	1200800850AP Sylinder
1200800900AP	1200800900AP Sylinder
1200800950AP	1200800950AP Sylinder
1200801000AP	1200801000AP Sylinder

Ø80 Pakninger Polyuretan: MED MAGNET

1210800025AP	1210800025AP Sylinder
1210800050AP	1210800050AP Sylinder
1210800075AP	1210800075AP Sylinder
1210800080AP	1210800080AP Sylinder
1210800100AP	1210800100AP Sylinder
1210800125AP	1210800125AP Sylinder
1210800150AP	1210800150AP Sylinder
1210800160AP	1210800160AP Sylinder
1210800200AP	1210800200AP Sylinder
1210800250AP	1210800250AP Sylinder
1210800300AP	1210800300AP Sylinder
1210800320AP	1210800320AP Sylinder
1210800350AP	1210800350AP Sylinder
1210800400AP	1210800400AP Sylinder
1210800450AP	1210800450AP Sylinder
1210800500AP	1210800500AP Sylinder
1210800550AP	1210800550AP Sylinder
1210800600AP	1210800600AP Sylinder
1210800650AP	1210800650AP Sylinder
1210800700AP	1210800700AP Sylinder
1210800750AP	1210800750AP Sylinder
1210800800AP	1210800800AP Sylinder
1210800850AP	1210800850AP Sylinder
1210800900AP	1210800900AP Sylinder
1210800950AP	1210800950AP Sylinder
1210801000AP	1210801000AP Sylinder



Artikkelnr.	Benevnelse
-------------	------------

Ø 100 mm DE

Ø100 Pakninger NBR: UTEN MAGNET	
1201000025AN	1201000025AN Sylinder
1201000050AN	1201000050AN Sylinder
1201000075AN	1201000075AN Sylinder
1201000080AN	1201000080AN Sylinder
1201000100AN	1201000100AN Sylinder
1201000125AN	1201000125AN Sylinder
1201000150AN	1201000150AN Sylinder
1201000160AN	1201000160AN Sylinder
1201000200AN	1201000200AN Sylinder
1201000250AN	1201000250AN Sylinder
1201000300AN	1201000300AN Sylinder
1201000320AN	1201000320AN Sylinder
1201000350AN	1201000350AN Sylinder
1201000400AN	1201000400AN Sylinder
1201000450AN	1201000450AN Sylinder
1201000500AN	1201000500AN Sylinder
1201000550AN	1201000550AN Sylinder
1201000600AN	1201000600AN Sylinder
1201000650AN	1201000650AN Sylinder
1201000700AN	1201000700AN Sylinder
1201000750AN	1201000750AN Sylinder
1201000800AN	1201000800AN Sylinder
1201000850AN	1201000850AN Sylinder
1201000900AN	1201000900AN Sylinder
1201000950AN	1201000950AN Sylinder
1201001000AN	1201001000AN Sylinder
Ø100 Pakninger NBR: MED MAGNET	
1211000025AN	1211000025AN Sylinder
1211000050AN	1211000050AN Sylinder
1211000075AN	1211000075AN Sylinder
1211000080AN	1211000080AN Sylinder
1211000100AN	1211000100AN Sylinder
1211000125AN	1211000125AN Sylinder
1211000150AN	1211000150AN Sylinder
1211000160AN	1211000160AN Sylinder
1211000200AN	1211000200AN Sylinder
1211000250AN	1211000250AN Sylinder
1211000300AN	1211000300AN Sylinder
1211000320AN	1211000320AN Sylinder
1211000350AN	1211000350AN Sylinder
1211000400AN	1211000400AN Sylinder
1211000450AN	1211000450AN Sylinder
1211000500AN	1211000500AN Sylinder
1211000550AN	1211000550AN Sylinder
1211000600AN	1211000600AN Sylinder
1211000650AN	1211000650AN Sylinder
1211000700AN	1211000700AN Sylinder
1211000750AN	1211000750AN Sylinder
1211000800AN	1211000800AN Sylinder
1211000850AN	1211000850AN Sylinder
1211000900AN	1211000900AN Sylinder
1211000950AN	1211000950AN Sylinder
1211001000AN	1211001000AN Sylinder

Artikkelnr.	Benevnelse
-------------	------------

Ø100 Pakninger Polyuretan: UTEN MAGNET	
1201000025AP	1201000025AP Sylinder
1201000050AP	1201000050AP Sylinder
1201000075AP	1201000075AP Sylinder
1201000080AP	1201000080AP Sylinder
1201000100AP	1201000100AP Sylinder
1201000125AP	1201000125AP Sylinder
1201000150AP	1201000150AP Sylinder
1201000160AP	1201000160AP Sylinder
1201000200AP	1201000200AP Sylinder
1201000250AP	1201000250AP Sylinder
1201000300AP	1201000300AP Sylinder
1201000320AP	1201000320AP Sylinder
1201000350AP	1201000350AP Sylinder
1201000400AP	1201000400AP Sylinder
1201000450AP	1201000450AP Sylinder
1201000500AP	1201000500AP Sylinder
1201000550AP	1201000550AP Sylinder
1201000600AP	1201000600AP Sylinder
1201000650AP	1201000650AP Sylinder
1201000700AP	1201000700AP Sylinder
1201000750AP	1201000750AP Sylinder
1201000800AP	1201000800AP Sylinder
1201000850AP	1201000850AP Sylinder
1201000900AP	1201000900AP Sylinder
1201000950AP	1201000950AP Sylinder
1201001000AP	1201001000AP Sylinder
Ø100 Pakninger Polyuretan: MED MAGNET	
1211000025AP	1211000025AP Sylinder
1211000050AP	1211000050AP Sylinder
1211000075AP	1211000075AP Sylinder
1211000080AP	1211000080AP Sylinder
1211000100AP	1211000100AP Sylinder
1211000125AP	1211000125AP Sylinder
1211000150AP	1211000150AP Sylinder
1211000160AP	1211000160AP Sylinder
1211000200AP	1211000200AP Sylinder
1211000250AP	1211000250AP Sylinder
1211000300AP	1211000300AP Sylinder
1211000320AP	1211000320AP Sylinder
1211000350AP	1211000350AP Sylinder
1211000400AP	1211000400AP Sylinder
1211000450AP	1211000450AP Sylinder
1211000500AP	1211000500AP Sylinder
1211000550AP	1211000550AP Sylinder
1211000600AP	1211000600AP Sylinder
1211000650AP	1211000650AP Sylinder
1211000700AP	1211000700AP Sylinder
1211000750AP	1211000750AP Sylinder
1211000800AP	1211000800AP Sylinder
1211000850AP	1211000850AP Sylinder
1211000900AP	1211000900AP Sylinder
1211000950AP	1211000950AP Sylinder
1211001000AP	1211001000AP Sylinder



Artikkelnr.	Benevnelse
-------------	------------

Ø 125 mm DE

Ø125 Pakninger NBR: UTEN MAGNET	
1201250025AN	1201250025AN Sylinder
1201250050AN	1201250050AN Sylinder
1201250075AN	1201250075AN Sylinder
1201250080AN	1201250080AN Sylinder
1201250100AN	1201250100AN Sylinder
1201250125AN	1201250125AN Sylinder
1201250150AN	1201250150AN Sylinder
1201250160AN	1201250160AN Sylinder
1201250200AN	1201250200AN Sylinder
1201250250AN	1201250250AN Sylinder
1201250300AN	1201250300AN Sylinder
1201250320AN	1201250320AN Sylinder
1201250350AN	1201250350AN Sylinder
1201250400AN	1201250400AN Sylinder
1201250450AN	1201250450AN Sylinder
1201250500AN	1201250500AN Sylinder
1201250550AN	1201250550AN Sylinder
1201250600AN	1201250600AN Sylinder
1201250650AN	1201250650AN Sylinder
1201250700AN	1201250700AN Sylinder
1201250750AN	1201250750AN Sylinder
1201250800AN	1201250800AN Sylinder
1201250850AN	1201250850AN Sylinder
1201250900AN	1201250900AN Sylinder
1201250950AN	1201250950AN Sylinder
1201251000AN	1201251000AN Sylinder
Ø125 Pakninger NBR: MED MAGNET	
1211250025AN	1211250025AN Sylinder
1211250050AN	1211250050AN Sylinder
1211250075AN	1211250075AN Sylinder
1211250080AN	1211250080AN Sylinder
1211250100AN	1211250100AN Sylinder
1211250125AN	1211250125AN Sylinder
1211250150AN	1211250150AN Sylinder
1211250160AN	1211250160AN Sylinder
1211250200AN	1211250200AN Sylinder
1211250250AN	1211250250AN Sylinder
1211250300AN	1211250300AN Sylinder
1211250350AN	1211250350AN Sylinder
1211250400AN	1211250400AN Sylinder
1211250450AN	1211250450AN Sylinder
1211250500AN	1211250500AN Sylinder
1211250550AN	1211250550AN Sylinder
1211250600AN	1211250600AN Sylinder
1211250650AN	1211250650AN Sylinder
1211250700AN	1211250700AN Sylinder
1211250750AN	1211250750AN Sylinder
1211250800AN	1211250800AN Sylinder
1211250850AN	1211250850AN Sylinder
1211250900AN	1211250900AN Sylinder
1211250950AN	1211250950AN Sylinder
1211251000AN	1211251000AN Sylinder

Artikkelnr.	Benevnelse
-------------	------------

Ø125 Pakninger Polyuretan: UTEN MAGNET	
1201250025AP	1201250025AP Sylinder
1201250050AP	1201250050AP Sylinder
1201250075AP	1201250075AP Sylinder
1201250080AP	1201250080AP Sylinder
1201250100AP	1201250100AP Sylinder
1201250125AP	1201250125AP Sylinder
1201250150AP	1201250150AP Sylinder
1201250160AP	1201250160AP Sylinder
1201250200AP	1201250200AP Sylinder
1201250250AP	1201250250AP Sylinder
1201250300AP	1201250300AP Sylinder
1201250320AP	1201250320AP Sylinder
1201250350AP	1201250350AP Sylinder
1201250400AP	1201250400AP Sylinder
1201250450AP	1201250450AP Sylinder
1201250500AP	1201250500AP Sylinder
1201250550AP	1201250550AP Sylinder
1201250600AP	1201250600AP Sylinder
1201250650AP	1201250650AP Sylinder
1201250700AP	1201250700AP Sylinder
1201250750AP	1201250750AP Sylinder
1201250800AP	1201250800AP Sylinder
1201250850AP	1201250850AP Sylinder
1201250900AP	1201250900AP Sylinder
1201250950AP	1201250950AP Sylinder
1201251000AP	1201251000AP Sylinder
Ø125 Pakninger Polyuretan: MED MAGNET	
1211250025AP	1211250025AP Sylinder
1211250050AP	1211250050AP Sylinder
1211250075AP	1211250075AP Sylinder
1211250080AP	1211250080AP Sylinder
1211250100AP	1211250100AP Sylinder
1211250125AP	1211250125AP Sylinder
1211250150AP	1211250150AP Sylinder
1211250160AP	1211250160AP Sylinder
1211250200AP	1211250200AP Sylinder
1211250250AP	1211250250AP Sylinder
1211250300AP	1211250300AP Sylinder
1211250350AP	1211250350AP Sylinder
1211250400AP	1211250400AP Sylinder
1211250450AP	1211250450AP Sylinder
1211250500AP	1211250500AP Sylinder
1211250550AP	1211250550AP Sylinder
1211250600AP	1211250600AP Sylinder
1211250650AP	1211250650AP Sylinder
1211250700AP	1211250700AP Sylinder
1211250750AP	1211250750AP Sylinder
1211250800AP	1211250800AP Sylinder
1211250850AP	1211250850AP Sylinder
1211250900AP	1211250900AP Sylinder
1211250950AP	1211250950AP Sylinder
1211251000AP	1211251000AP Sylinder



SYLINDERE ISO 6431

Benevnelse

SYLINDERE ISO 6431 Ø 32 ÷ Ø125

HØY TEMPERATUR, RUSTFRI STEMPELSTANG1.....ZV
+ VITONPAKNINGER

HØY TEMPERATUR, HARDFORKROMET 1.....AV
STEMPELSTANG + VITONPAKNINGER

KANIGENBEHANDLET 1.....KN
+ NBR-PAKNINGER

KANIGENBEHANDLET 1.....KP
+ POLYURETANPAKNINGER

KANIGENBEHANDLET 1.....LS
RESINFYLTE GAVLER

SYLINDER FOR LAVTRYKKSHYDRAULIKK 1.....T

RESINFYLTE GAVLER 1.....RP

GJENNOMGÅENDE STEMPELSTANG 122....

LAVFRIKSJONSYLINDER 123....

UTEN ENDESLAGSBREMS 124....

4-NIVÅ SYLINDER 125....

ENKELVIRKENDE 126....

TANDEMUTFØRELSE 127....

FORLENGET ENDESLAGSBREMS 131....

SYLINDER FOR STEMPELSTANGSLÅSING 134....

SYLINDER MED DEMPET LYDNIVÅ 135....

FOR STEMPELSTANGSLÅSING 137....
OG LINEÆRSTYRING

FLERPOSISJONSYLINDER 147....

RUSTFRI STEMPELSTANG

SYLINDER "NO STICK SLIP" G som fjerde
(for ekstremt lav hastighet) posisjon

ØVRIGE SPESIALUTFØRELSER

LUFTBEHOLDER

Artikkelnr. Benevnelse

SYLINDERE ISO 6431 Ø160 ÷ Ø200

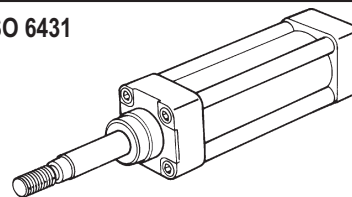

Ø 160 mm DE

Ø160: UTEN MAGNET

W1201600025	6431 DE 160-0025	Sylinder
W1201600050	6431 DE 160-0050	Sylinder
W1201600075	6431 DE 160-0075	Sylinder
W1201600080	6431 DE 160-0080	Sylinder
W1201600100	6431 DE 160-0100	Sylinder
W1201600125	6431 DE 160-0125	Sylinder
W1201600150	6431 DE 160-0150	Sylinder
W1201600200	6431 DE 160-0200	Sylinder
W1201600250	6431 DE 160-0250	Sylinder
W1201600300	6431 DE 160-0300	Sylinder
W1201600320	6431 DE 160-0320	Sylinder
W1201600350	6431 DE 160-0350	Sylinder
W1201600400	6431 DE 160-0400	Sylinder
W1201600500	6431 DE 160-0500	Sylinder
W1201600600	6431 DE 160-0600	Sylinder
W1201600700	6431 DE 160-0700	Sylinder
W1201600800	6431 DE 160-0800	Sylinder
W1201600900	6431 DE 160-0900	Sylinder
W1201601000	6431 DE 160-1000	Sylinder

Ø160: MED MAGNET

W1211600025	6431 DEM 160-0025	Sylinder
W1211600050	6431 DEM 160-0050	Sylinder
W1211600075	6431 DEM 160-0075	Sylinder
W1211600080	6431 DEM 160-0080	Sylinder
W1211600100	6431 DEM 160-0100	Sylinder
W1211600125	6431 DEM 160-0125	Sylinder
W1211600150	6431 DEM 160-0150	Sylinder
W1211600200	6431 DEM 160-0200	Sylinder
W1211600250	6431 DEM 160-0250	Sylinder
W1211600300	6431 DEM 160-0300	Sylinder
W1211600320	6431 DEM 160-0320	Sylinder
W1211600350	6431 DEM 160-0350	Sylinder
W1211600400	6431 DEM 160-0400	Sylinder
W1211600500	6431 DEM 160-0500	Sylinder
W1211600600	6431 DEM 160-0600	Sylinder
W1211600700	6431 DEM 160-0700	Sylinder
W1211600800	6431 DEM 160-0800	Sylinder
W1211600900	6431 DEM 160-0900	Sylinder
W1211601000	6431 DEM 160-1000	Sylinder

LINEÆRSTYRING SYLINDERE ISO 6431

Artikkelnr.	Benevnelse
-------------	------------

Ø 200 mm DE

Ø200: UTEN MAGNET	
W1202000025	6431 DE 200-0025 Sylinder
W1202000050	6431 DE 200-0050 Sylinder
W1202000075	6431 DE 200-0075 Sylinder
W1202000080	6431 DE 200-0080 Sylinder
W1202000100	6431 DE 200-0100 Sylinder
W1202000125	6431 DE 200-0125 Sylinder
W1202000150	6431 DE 200-0150 Sylinder
W1202000200	6431 DE 200-0200 Sylinder
W1202000250	6431 DE 200-0250 Sylinder
W1202000300	6431 DE 200-0300 Sylinder
W1202000320	6431 DE 200-0320 Sylinder
W1202000350	6431 DE 200-0350 Sylinder
W1202000400	6431 DE 200-0400 Sylinder
W1202000500	6431 DE 200-0500 Sylinder
W1202000600	6431 DE 200-0600 Sylinder
W1202000700	6431 DE 200-0700 Sylinder
W1202000800	6431 DE 200-0800 Sylinder
W1202000900	6431 DE 200-0900 Sylinder
W1202001000	6431 DE 200-1000 Sylinder
Ø200: MED MAGNET	
W1212000025	6431 DEM 200-0025 Sylinder
W1212000050	6431 DEM 200-0050 Sylinder
W1212000075	6431 DEM 200-0075 Sylinder
W1212000080	6431 DEM 200-0080 Sylinder
W1212000100	6431 DEM 200-0100 Sylinder
W1212000125	6431 DEM 200-0125 Sylinder
W1212000150	6431 DEM 200-0150 Sylinder
W1212000200	6431 DEM 200-0200 Sylinder
W1212000250	6431 DEM 200-0250 Sylinder
W1212000300	6431 DEM 200-0300 Sylinder
W1212000320	6431 DEM 200-0320 Sylinder
W1212000350	6431 DEM 200-0350 Sylinder
W1212000400	6431 DEM 200-0400 Sylinder
W1212000500	6431 DEM 200-0500 Sylinder
W1212000600	6431 DEM 200-0600 Sylinder
W1212000700	6431 DEM 200-0700 Sylinder
W1212000800	6431 DEM 200-0800 Sylinder
W1212000900	6431 DEM 200-0900 Sylinder
W1212001000	6431 DEM 200-1000 Sylinder

Artikkelnr.	Benevnelse
-------------	------------

DS: U-PROFIL NORMAL LAST LAV HASTIGHET

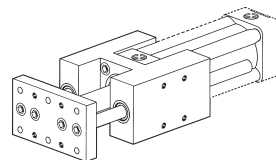

W0700321050	MWDS 032-0050 Lineærstyring
W0700321100	MWDS 032-0100 Lineærstyring
W0700321150	MWDS 032-0150 Lineærstyring
W0700321200	MWDS 032-0200 Lineærstyring
W0700321250	MWDS 032-0250 Lineærstyring
W0700321320	MWDS 032-0320 Lineærstyring
W0700321400	MWDS 032-0400 Lineærstyring
W0700321500	MWDS 032-0500 Lineærstyring
W0700401050	MWDS 040-0050 Lineærstyring
W0700401100	MWDS 040-0100 Lineærstyring
W0700401150	MWDS 040-0150 Lineærstyring
W0700401200	MWDS 040-0200 Lineærstyring
W0700401250	MWDS 040-0250 Lineærstyring
W0700401320	MWDS 040-0320 Lineærstyring
W0700401400	MWDS 040-0400 Lineærstyring
W0700401500	MWDS 040-0500 Lineærstyring
W0700501050	MWDS 050-0050 Lineærstyring
W0700501100	MWDS 050-0100 Lineærstyring
W0700501150	MWDS 050-0150 Lineærstyring
W0700501200	MWDS 050-0200 Lineærstyring
W0700501250	MWDS 050-0250 Lineærstyring
W0700501320	MWDS 050-0320 Lineærstyring
W0700501400	MWDS 050-0400 Lineærstyring
W0700501500	MWDS 050-0500 Lineærstyring
W0700631050	MWDS 063-0050 Lineærstyring
W0700631100	MWDS 063-0100 Lineærstyring
W0700631150	MWDS 063-0150 Lineærstyring
W0700631200	MWDS 063-0200 Lineærstyring
W0700631250	MWDS 063-0250 Lineærstyring
W0700631320	MWDS 063-0320 Lineærstyring
W0700631400	MWDS 063-0400 Lineærstyring
W0700631500	MWDS 063-0500 Lineærstyring
W0700801050	MWDS 080-0050 Lineærstyring
W0700801100	MWDS 080-0100 Lineærstyring
W0700801150	MWDS 080-0150 Lineærstyring
W0700801200	MWDS 080-0200 Lineærstyring
W0700801250	MWDS 080-0250 Lineærstyring
W0700801320	MWDS 080-0320 Lineærstyring
W0700801400	MWDS 080-0400 Lineærstyring
W0700801500	MWDS 080-0500 Lineærstyring
W0701001050	MWDS 100-0050 Lineærstyring
W0701001100	MWDS 100-0100 Lineærstyring
W0701001150	MWDS 100-0150 Lineærstyring
W0701001200	MWDS 100-0200 Lineærstyring
W0701001250	MWDS 100-0250 Lineærstyring
W0701001320	MWDS 100-0320 Lineærstyring
W0701001400	MWDS 100-0400 Lineærstyring
W0701001500	MWDS 100-0500 Lineærstyring



Artikkelnr. Benevnelse

**DH: H-PROFIL
TUNG LAST**

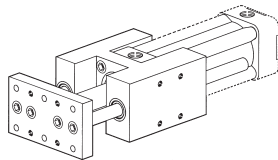

W0700322050	MWDH 032-0050 Lineærstyring
W0700322100	MWDH 032-0100 Lineærstyring
W0700322150	MWDH 032-0150 Lineærstyring
W0700322200	MWDH 032-0200 Lineærstyring
W0700322250	MWDH 032-0250 Lineærstyring
W0700322320	MWDH 032-0320 Lineærstyring
W0700322400	MWDH 032-0400 Lineærstyring
W0700322500	MWDH 032-0500 Lineærstyring
W0700402050	MWDH 040-0050 Lineærstyring
W0700402100	MWDH 040-0100 Lineærstyring
W0700402150	MWDH 040-0150 Lineærstyring
W0700402200	MWDH 040-0200 Lineærstyring
W0700402250	MWDH 040-0250 Lineærstyring
W0700402320	MWDH 040-0320 Lineærstyring
W0700402400	MWDH 040-0400 Lineærstyring
W0700402500	MWDH 040-0500 Lineærstyring
W0700502050	MWDH 050-0050 Lineærstyring
W0700502100	MWDH 050-0100 Lineærstyring
W0700502150	MWDH 050-0150 Lineærstyring
W0700502200	MWDH 050-0200 Lineærstyring
W0700502250	MWDH 050-0250 Lineærstyring
W0700502320	MWDH 050-0320 Lineærstyring
W0700502400	MWDH 050-0400 Lineærstyring
W0700502500	MWDH 050-0500 Lineærstyring
W0700632050	MWDH 063-0050 Lineærstyring
W0700632100	MWDH 063-0100 Lineærstyring
W0700632150	MWDH 063-0150 Lineærstyring
W0700632200	MWDH 063-0200 Lineærstyring
W0700632250	MWDH 063-0250 Lineærstyring
W0700632320	MWDH 063-0320 Linjärstyring
W0700632400	MWDH 063-0400 Lineærstyring
W0700632500	MWDH 063-0500 Lineærstyring
W0700802050	MWDH 080-0050 Lineærstyring
W0700802100	MWDH 080-0100 Lineærstyring
W0700802150	MWDH 080-0150 Lineærstyring
W0700802200	MWDH 080-0200 Lineærstyring
W0700802250	MWDH 080-0250 Lineærstyring
W0700802320	MWDH 080-0320 Lineærstyring
W0700802400	MWDH 080-0400 Lineærstyring
W0700802500	MWDH 080-0500 Lineærstyring
W0701002050	MWDH 100-0050 Lineærstyring
W0701002100	MWDH 100-0100 Lineærstyring
W0701002150	MWDH 100-0150 Lineærstyring
W0701002200	MWDH 100-0200 Lineærstyring
W0701002250	MWDH 100-0250 Lineærstyring
W0701002320	MWDH 100-0320 Lineærstyring
W0701002400	MWDH 100-0400 Lineærstyring
W0701002500	MWDH 100-0500 Lineærstyring

Artikkelnr. Benevnelse

**DM: H-PROFIL
HØY HASTIGHET**

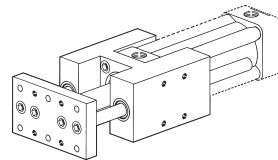

W0700323050	MWDM 032-0050 Lineærstyring
W0700323100	MWDM 032-0100 Lineærstyring
W0700323150	MWDM 032-0150 Lineærstyring
W0700323200	MWDM 032-0200 Lineærstyring
W0700323250	MWDM 032-0250 Lineærstyring
W0700323320	MWDM 032-0320 Lineærstyring
W0700323400	MWDM 032-0400 Lineærstyring
W0700323500	MWDM 032-0500 Lineærstyring
W0700403050	MWDM 040-0050 Lineærstyring
W0700403100	MWDM 040-0100 Lineærstyring
W0700403150	MWDM 040-0150 Lineærstyring
W0700403200	MWDM 040-0200 Lineærstyring
W0700403250	MWDM 040-0250 Lineærstyring
W0700403320	MWDM 040-0320 Lineærstyring
W0700403400	MWDM 040-0400 Lineærstyring
W0700403500	MWDM 040-0500 Lineærstyring
W0700503050	MWDM 050-0050 Lineærstyring
W0700503100	MWDM 050-0100 Lineærstyring
W0700503150	MWDM 050-0150 Lineærstyring
W0700503200	MWDM 050-0200 Lineærstyring
W0700503250	MWDM 050-0250 Lineærstyring
W0700503320	MWDM 050-0320 Lineærstyring
W0700503400	MWDM 050-0400 Lineærstyring
W0700503500	MWDM 050-0500 Lineærstyring
W0700633050	MWDM 063-0050 Lineærstyring
W0700633100	MWDM 063-0100 Lineærstyring
W0700633150	MWDM 063-0150 Lineærstyring
W0700633200	MWDM 063-0200 Lineærstyring
W0700633250	MWDM 063-0250 Lineærstyring
W0700633320	MWDM 063-0320 Lineærstyring
W0700633400	MWDM 063-0400 Lineærstyring
W0700633500	MWDM 063-0500 Lineærstyring
W0700803050	MWDM 080-0050 Lineærstyring
W0700803100	MWDM 080-0100 Lineærstyring
W0700803150	MWDM 080-0150 Lineærstyring
W0700803200	MWDM 080-0200 Lineærstyring
W0700803250	MWDM 080-0250 Lineærstyring
W0700803320	MWDM 080-0320 Lineærstyring
W0700803400	MWDM 080-0400 Lineærstyring
W0700803500	MWDM 080-0500 Lineærstyring
W0701003050	MWDM 100-0050 Lineærstyring
W0701003100	MWDM 100-0100 Lineærstyring
W0701003150	MWDM 100-0150 Lineærstyring
W0701003200	MWDM 100-0200 Lineærstyring
W0701003250	MWDM 100-0250 Lineærstyring
W0701003320	MWDM 100-0320 Lineærstyring
W0701003400	MWDM 100-0400 Lineærstyring
W0701003500	MWDM 100-0500 Lineærstyring

**MEKANISK
STEMPELSTANGLÅS**

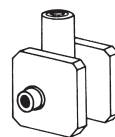

W5010001102	MA 7032/LD Stempelstangslås
W5010001103	MA 7040/LD Stempelstangslås
W5010001104	MA 7050/LD Stempelstangslås
W5010001109	MA 7063/LDM Stempelstangslås
W5010001106	MA 7080/LD Stempelstangslås
W5010001107	MA 7100/LD Stempelstangslås
W5010001108	MA 7125/LD Stempelstangslås

FESTE SYLINDERE ISO 6431



Artikkelnr.	Benevnelse
-------------	------------

FOTFESTE A

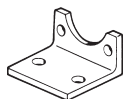

W0950322001	A-032 Fotfeste
W0950402001	A-040 Fotfeste
W0950502001	A-050 Fotfeste
W0950632001	A-063 Fotfeste
W0950802001	A-080 Fotfeste
W0951002001	A-100 Fotfeste
W0951252001	A-125 Fotfeste

SVINGFESTE B

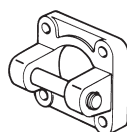

W0950322003	B-032 Svingfeste+tapp
W0950402003	B-040 Svingfeste+tapp
W0950502003	B-050 Svingfeste+tapp
W0950632003	B-063 Svingfeste+tapp
W0950802003	B-080 Svingfeste+tapp
W0951002003	B-100 Svingfeste+tapp
W0951252003	B-125 Svingfeste+tapp

SIVINGFESTE BA

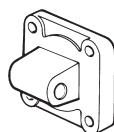

W0950322004	BA-032 Svingfeste
W0950402004	BA-040 Svingfeste
W0950502004	BA-050 Svingfeste
W0950632004	BA-063 Svingfeste
W0950802004	BA-080 Svingfeste
W0951002004	BA-100 Svingfeste
W0951252004	BA-125 Svingfeste

KULELEDDFESTE BAS

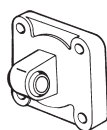

W0950322006	BAS-032 Kuleleddfeste
W0950402006	BAS-040 Kuleleddfeste
W0950502006	BAS-050 Kuleleddfeste
W0950632006	BAS-063 Kuleleddfeste
W0950802006	BAS-080 Kuleleddfeste
W0951002006	BAS-100 Kuleleddfeste
W0951252006	BAS-125 Kuleleddfeste

VINKELFESTE GL "CETOP" FOR FESTE B



W0950322008	GL-032 Vinkelfeste CETOP
W0950402008	GL-040 Vinkelfeste CETOP
W0950502008	GL-050 Vinkelfeste CETOP
W0950632008	GL-063 Vinkelfeste CETOP
W0950802008	GL-080 Vinkelfeste CETOP
W0951002008	GL-100 Vinkelfeste CETOP
W0951252008	GL-125 Vinkelfeste CETOP

Artikkelnr.	Benevnelse
-------------	------------

VINKELFESTE GS "ISO" FOR FESTE B

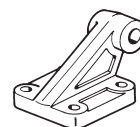

W0950322108	GS-032 Vinkelfeste ISO
W0950402108	GS-040 Vinkelfeste ISO
W0950502108	GS-050 Vinkelfeste ISO
W0950632108	GS-063 Vinkelfeste ISO
W0950802108	GS-080 Vinkelfeste ISO
W0951002108	GS-100 Vinkelfeste ISO

FLENSFESTE C

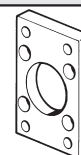

W0950322002	C-032 Flensfeste
W0950402002	C-040 Flensfeste
W0950502002	C-050 Flensfeste
W0950632002	C-063 Flensfeste
W0950802002	C-080 Flensfeste
W0951002002	C-100 Flensfeste
W0951252002	C-125 Flensfeste

MIDJEFESTE EN

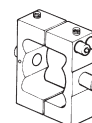

0950322007	EN-032 Midjefeste
0950402007	EN-040 Midjefeste
0950502007	EN-050 Midjefeste
0950632007	EN-063 Midjefeste
0950802007	EN-080 Midjefeste
0951002007	EN-100 Midjefeste
0951252007	EN-125 Midjefeste

OPPHENG EL FOR MIDJEFESTE EN

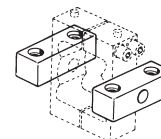

W0950322009	EL-032 Oppheng
W0950402009	EL-040/050 Oppheng
W0950632009	EL-063/080 Oppheng
W0951002009	EL-100/125 Oppheng

STEMPELSTANGSMUTTER



0950322010	S-032/025 Stempelstangsmutter
0950402010	S-040 Stempelstangsmutter
0950502010	S-050/063 Stempelstangsmutter
0950802010	S-080/100 Stempelstangsmutter
0951002010	S-100 Stempelstangsmutter
0951252010	S-125 Stempelstangsmutter



Artikkelnr.	Benevnelse
-------------	------------

GAFFELFESTE GK-M

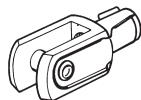

W0950322020	GK-M-032/025 Gaffelfeste
W0950402020	GK-M-040 Gaffelfeste
W0950502020	GK-M-050/063 Gaffelfeste
W0950802020	GK-M-080/100 Gaffelfeste
W0951252020	GK-M-125 Gaffelfeste

KULELEDDFESTE GA-M



W0950322025	GA-M-032/025 Kuleleddfeste
W0950402025	GA-M-040 Kuleleddfeste
W0950502025	GA-M-050/063 Kuleleddfeste
W0950802025	GA-M-080/100 Kuleleddfeste
W0951252025	GA-M-125 Kuleleddfeste

VRIBAR STEMPELSTANGSENDE GA-K

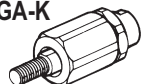

W0950322030	GA-K-032 Stempelstangsende
W0950402030	GA-K-040 Stempelstangsende
W0950502030	GA-K-050/063 Stempelstangsende
W0950802030	GA-K-080/100 Stempelstangsende

FESTESETT FOR MONTERING AV VENTIL PÅ SYLINDER

0950002001	KIT ISO 1 Festesett
0950002002	KIT ISO 2 Festesett
0950002003	KIT MACH 16 Festesett
0950002004	KIT SOV 1/8-1/4 Festesett
0950002006	KIT SOV 1/2 Festesett

PLATE FOR MONTERING AV VENTIL PÅ SYLINDERE

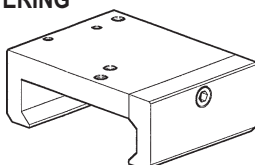

0950322090	KCV-32 Plate
0950402090	KCV-40 Plate
0950502090	KCV-50 Plate
0950632090	KCV-63 Plate
0950802090	KCV-80 Plate
0951002090	KCV-100 Plate
0951252090	KCV-125 Plate

Artikkelnr.	Benevnelse
-------------	------------

MAGNETFØLER

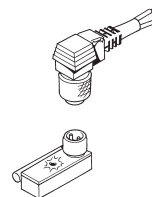

W0950000201	DSM2-C525 NO Reedkontakt
W0950000222	PNP DSM3-N225 Hallkontakt
W0950000232	NPN DSM3-M225 Hallkontakt

FESTEBØYLE FOR MAGNETFØLER



W0950000711	DST80 D.32/40 Festebøyle
W0950000712	DST81 D.50/63 Festebøyle
W0950000713	DST82 D.80/100/125 Festebøyle

FORLEGNINGSHOLDER (BRUKES I KOMBINASJON MED LINEÆRSTYRING)

0950000800	Forl. holder for syl.
------------	-----------------------

PLATE FOR MONTERING AV VENTIL PNV-SOV-ISV-IPV-MACH16 PÅ SYLINDER ISO 6431 32÷125

0950322090	KCV-32 Plate
0950402090	KCV-40 Plate
0950502090	KCV-50 Plate
0950632090	KCV-63 Plate
0950802090	KCV-80 Plate
0951002090	KCV-100 Plate
0951252090	KCV-125 Plate

FESTESETT FOR MONTERING AV VENTIL PÅ SYLINDER ISO 6431

0950002001	KIT ISO 1 Festesett
0950002002	KIT ISO 2 Festesett
0950002003	KIT MACH 16 Festesett
0950002004	KIT SOV 1/8-1/4 Festesett
0950002006	KIT SOV 1/2 Festesett

RESERVEDELER ISO 6431



Artikkelnr.	Benevnelse
-------------	------------

Ø32 NBR

0090320502	Komplett pakningsett Ø32 NBR
0090320304	Gavlesett fremre Ø32 NBR
0090320305	Gavlesett bakre Ø32 NBR
0090320602	Stemp.stagsett inkl. pakning Ø32 NBR
0090320702	Komplett sett Ø40 NBR
0090320800	Magnet Ø32 ISO 6431

Ø40 NBR

0090400502	Komplett pakningsett Ø40 NBR
0090400304	Gavlesett fremre Ø40 NBR
0090400305	Gavlesett bakre Ø40 NBR
0090400602	Stemp.stagsett inkl. pakning Ø40 NBR
0090400702	Komplett sett Ø40 NBR
0090400800	Magnet Ø40 ISO 6431

Ø50 NBR

0090500502	Komplett pakningsett Ø50 NBR
0090500304	Gavlesett fremre Ø50 NBR
0090500305	Gavlesett bakre Ø50 NBR
0090500602	Stemp.stagsett inkl. pakning Ø50 NBR
0090500702	Komplett sett Ø50 NBR
0090500800	Magnet Ø50 ISO 6431

Ø63 NBR

0090630502	Komplett pakningsett Ø63 NBR
0090630304	Gavlesett fremre Ø63 NBR
0090630305	Gavlesett bakre Ø63 NBR
0090630602	Stemp.stagsett inkl. pakning Ø63 NBR
0090630702	Komplett sett Ø63 NBR
0090630800	Magnet Ø63 ISO 6431

Ø80 NBR

0090800502	Komplett pakningsett Ø80 NBR
0090800304	Gavlesett fremre Ø80 NBR
0090800305	Gavlesett bakre Ø80 NBR
0090800602	Stemp.stagsett inkl. pakning Ø80 NBR
0090800702	Komplett sett Ø80 NBR
0090800800	Magnet Ø80 ISO 6431

Ø100 NBR

0091000502	Komplett pakningsett Ø100 NBR
0091000304	Gavlesett fremre Ø100 NBR
0091000305	Gavlesett bakre Ø100 NBR
0091000602	Stemp.stagsett inkl. pakning Ø100 NBR
0091000702	Komplett sett Ø100 NBR
0091000800	Magnet Ø100 ISO 6431

Ø125 NBR

0091250502	Komplett pakningsett Ø125 NBR
0091250304	Gavlesett fremre Ø125 NBR
0091250305	Gavlesett bakre Ø125 NBR
0091250602	Stemp.stagsett inkl. pakning Ø125 NBR
0091250702	Komplett sett Ø125 NBR
0091250800	Magnet Ø125 ISO 6431

Artikkelnr.	Benevnelse
-------------	------------

Ø32 POLYURETAN

0090320101	Komplett pakningsett Ø32 PU
0090320110	Gavlesett fremre Ø32 PU
0090320111	Gavlesett bakre Ø32 PU
0090320604	Stemp.stagsett inkl. pakning Ø32 PU
0090320704	Komplett sett Ø32 PU
0090320800	Magnet Ø32 ISO 6431

Ø40 POLYURETAN

0090400101	Komplett pakningsett Ø40 PU
0090400110	Gavlesett fremre Ø40 PU
0090400111	Gavlesett bakre Ø40 PU
0090400604	Stemp.stagsett inkl. pakning Ø40 PU
0090400704	Komplett sett Ø40 PU
0090400800	Magnet Ø40 ISO 6431

Ø50 POLYURETAN

0090500101	Komplett pakningsett Ø50 PU
0090500110	Gavlesett fremre Ø50 PU
0090500111	Gavlesett bakre Ø50 PU
0090500604	Stemp.stagsett inkl. pakning Ø50 PU
0090500704	Komplett sett Ø50 PU
0090500800	Magnet Ø50 ISO 6431

Ø63 POLYURETAN

0090630101	Komplett pakningsett Ø63 PU
0090630110	Gavlesett fremre Ø63 PU
0090630111	Gavlesett bakre Ø63 PU
0090630604	Stemp.stagsett inkl. pakning Ø63 PU
0090630704	Komplett sett Ø63 PU
0090630800	Magnet Ø63 ISO 6431

Ø80 POLYURETAN

0090800101	Komplett pakningsett Ø80 PU
0090800110	Gavlesett fremre Ø80 PU
0090800111	Gavlesett bakre Ø80 PU
0090800604	Stemp.stagsett inkl. pakning Ø80 PU
0090800704	Komplett sett Ø80 PU
0090800800	Magnet Ø80 ISO 6431

Ø100 POLYURETAN

0091000101	Komplett pakningsett Ø100 PU
0091000110	Gavlesett fremre Ø100 PU
0091000111	Gavlesett bakre Ø100 PU
0091000604	Stemp.stagsett inkl. pakning Ø100 PU
0091000704	Komplett sett Ø100 PU
0091000800	Magnet Ø100 ISO 6431

Ø125 POLYURETAN

0091250101	Komplett pakningsett Ø125 PU
0091250110	Gavlesett fremre Ø125 PU
0091250111	Gavlesett bakre Ø125 PU
0091250604	Stemp.stagsett inkl. pakning Ø125 PU
0091250704	Komplett sett Ø125 PU
0091250800	Magnet Ø125 ISO 6431



FESTE ISO 6431 Ø160 ÷ Ø200

Artikkelnr. Benevnelse

FOTFESTE A

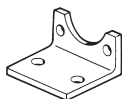

W0951602001 A-160 Fotfeste
W0952002001 A-200 Fotfeste

SVINGFESTE B

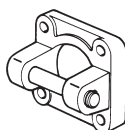

W0951602003 B-160 Svingfeste+tapp
W0952002003 B-200 Svingfeste+tapp

FLENSFESTE C

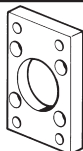

W0951602002 C-160 Flensfeste
W0952002002 C-200 Flensfeste

SVINGFESTE BA

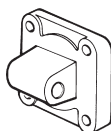

W0951602004 BA-160 Svingfeste
W0952002004 BA-200 Svingfeste

MIDJEFESTE EN

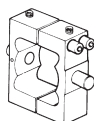

W0951602007 EN-160 Midjefeste
W0952002007 EN-200 Midjefeste

VINKELFESTE GL CETOP

W0951602008 GL-160/200 Vinkelfeste CETOP

KULELEDDFESTE GA-M



W0952002025 GA-M-160/200 Kuleleddfeste

Artikkelnr. Benevnelse

GAFFELFESTE GK-M

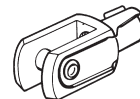

W0951602020 GK-M-160/200 Gaffelfeste

STEMPELSTANGSMUTTER S



W0951602010 S-160/200 Stempelstangsmutter

MAGNETFØLER

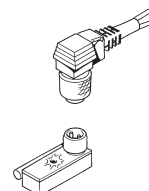

W0950000201 DSM2-C525 NO Reedkontakt
W0950000222 PNP DSM3-N225 Hallkontakt
W0950000232 NPN DSM3-M225 Hallkontakt

FESTEBØYLE FOR MAGNETFØLER



W0950000715 ST 160 Festeboyle
W0950000716 ST 200 Festeboyle

TVILLINGSYLINDERE



Artikkelnr.	Benevnelse
-------------	------------

TVILLINGSYLINDERE Ø32 ÷ Ø100

Ø32	
W1400320025	TWNC-032-0025-DMA0-00
W1400320050	TWNC-032-0050-DMA0-00
W1400320080	TWNC-032-0080-DMA0-00
W1400320100	TWNC-032-0100-DMA0-00
W1400320125	TWNC-032-0125-DMA0-00
W1400320160	TWNC-032-0160-DMA0-00
W1400320200	TWNC-032-0200-DMA0-00
W1400320250	TWNC-032-0250-DMA0-00
W1400320320	TWNC-032-0320-DMA0-00

Ø40	
W1400400025	TWNC-040-0025-DMA0-00
W1400400050	TWNC-040-0050-DMA0-00
W1400400080	TWNC-040-0080-DMA0-00
W1400400100	TWNC-040-0100-DMA0-00
W1400400125	TWNC-040-0125-DMA0-00
W1400400160	TWNC-040-0160-DMA0-00
W1400400200	TWNC-040-0200-DMA0-00
W1400400250	TWNC-040-0250-DMA0-00
W1400400320	TWNC-040-0320-DMA0-00
W1400400400	TWNC-040-0400-DMA0-00
W1400400500	TWNC-040-0500-DMA0-00

Ø50	
W1400500025	TWNC-050-0025-DMA0-00
W1400500050	TWNC-050-0050-DMA0-00
W1400500080	TWNC-050-0080-DMA0-00
W1400500100	TWNC-050-0100-DMA0-00
W1400500125	TWNC-050-0125-DMA0-00
W1400500160	TWNC-050-0160-DMA0-00
W1400500200	TWNC-050-0200-DMA0-00
W1400500250	TWNC-050-0250-DMA0-00
W1400500320	TWNC-050-0320-DMA0-00
W1400500400	TWNC-050-0400-DMA0-00
W1400500500	TWNC-050-0500-DMA0-00

Ø63	
W1400630025	TWNC-063-0025-DMA0-00
W1400630050	TWNC-063-0050-DMA0-00
W1400630080	TWNC-063-0080-DMA0-00
W1400630100	TWNC-063-0100-DMA0-00
W1400630125	TWNC-063-0125-DMA0-00
W1400630160	TWNC-063-0160-DMA0-00
W1400630200	TWNC-063-0200-DMA0-00
W1400630250	TWNC-063-0250-DMA0-00
W1400630320	TWNC-063-0320-DMA0-00
W1400630400	TWNC-063-0400-DMA0-00
W1400630500	TWNC-063-0500-DMA0-00

Artikkelnr.	Benevnelse
-------------	------------

TVILLINGSYLINDERE Ø32 ÷ Ø100

Ø80	
W1400800025	TWNC-080-0025-DMA0-00
W1400800050	TWNC-080-0050-DMA0-00
W1400800080	TWNC-080-0080-DMA0-00
W1400800100	TWNC-080-0100-DMA0-00
W1400800125	TWNC-080-0125-DMA0-00
W1400800160	TWNC-080-0160-DMA0-00
W1400800200	TWNC-080-0200-DMA0-00
W1400800250	TWNC-080-0250-DMA0-00
W1400800320	TWNC-080-0320-DMA0-00
W1400800400	TWNC-080-0400-DMA0-00
W1400800500	TWNC-080-0500-DMA0-00

Ø100	
W1401000025	TWNC-100-0025 DMA0-00
W1401000050	TWNC-100-0050 DMA0-00
W1401000080	TWNC-100-0080 DMA0-00
W1401000100	TWNC-100-0100 DMA0-00
W1401000125	TWNC-100-0125 DMA0-00
W1401000160	TWNC-100-0160 DMA0-00
W1401000200	TWNC-100-0200 DMA0-00
W1401000250	TWNC-100-0250 DMA0-00
W1401000320	TWNC-100-0320 DMA0-00
W1401000400	TWNC-100-0400 DMA0-00
W1401000500	TWNC-100-0500 DMA0-00

GJENNOMGÅENDE STEMPELSTANG W141.....

GJENNOMGÅENDE ENKEL STEMPELSTANG W142.....

Artikkelnr.	Benevnelse
-------------	------------

FLENSFESTE C/S

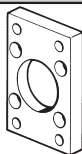

W0950323002	C/S-032 Flensfeste
W0950403002	C/S-040 Flensfeste
W0950503002	C/S-050 Flensfeste
W0950633002	C/S-063 Flensfeste
W0950803002	C/S-080 Flensfeste
W0951003002	C/S-100 Flensfeste

FOTFESTE A/S

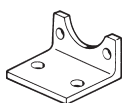

W0950323001	A/S-032 Fotfeste
W0950403001	A/S-040 Fotfeste
W0950503001	A/S-050 Fotfeste
W0950633001	A/S-063 Fotfeste
W0950803001	A/S-080 Fotfeste
W0951003001	A/S-100 Fotfeste

SVINGFESTE B

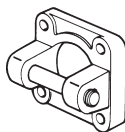

W0950322003	B-032 Svingfeste+tapp
W0950402003	B-040 Svingfeste+tapp
W0950502003	B-050 Svingfeste+tapp
W0950632003	B-063 Svingfeste+tapp
W0950802003	B-080 Svingfeste+tapp
W0951002003	B-100 Svingfeste+tapp

SVINGFESTE BA

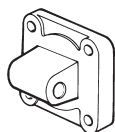

W0950322004	BA-032 Svingfeste
W0950402004	BA-040 Svingfeste
W0950502004	BA-050 Svingfeste
W0950632004	BA-063 Svingfeste
W0950802004	BA-080 Svingfeste
W0951002004	BA-100 Svingfeste

KULELEDDFESTE BAS

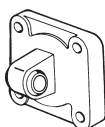

W0950322006	BAS-032 Kuleleddfeste
W0950402006	BAS-040 Kuleleddfeste
W0950502006	BAS-050 Kuleleddfeste
W0950632006	BAS-063 Kuleleddfeste
W0950802006	BAS-080 Kuleleddfeste
W0951002006	BAS-100 Kuleleddfeste

Artikkelnr.	Benevnelse
-------------	------------

VINKELFESTE GL CETOP

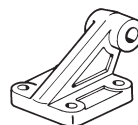

W0950322008	GL-032 Vinkelfeste CETOP
W0950402008	GL-040 Vinkelfeste CETOP
W0950502008	GL-050 Vinkelfeste CETOP
W0950632008	GL-063 Vinkelfeste CETOP
W0950802008	GL-080 Vinkelfeste CETOP
W0951002008	GL-100 Vinkelfeste CETOP

VINKELFESTE GS ISO

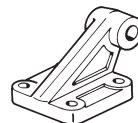

W0950322108	GS-032 Vinkelfeste ISO
W0950402108	GS-040 Vinkelfeste ISO
W0950502108	GS-050 Vinkelfeste ISO
W0950632108	GS-063 Vinkelfeste ISO
W0950802108	GS-080 Vinkelfeste ISO
W0951002108	GS-100 Vinkelfeste ISO

MIDJEFESTE EN

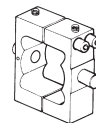

0950322007	EN-032 Midjefeste
0950402007	EN-040 Midjefeste
0950502007	EN-050 Midjefeste
0950632007	EN-063 Midjefeste
0950802007	EN-080 Midjefeste
0951002007	EN-100 Midjefeste

OPPHENG EL

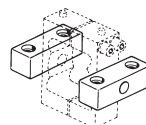

W0950322009	EL-032 Oppheng
W0950402009	EL-040/050 Oppheng
W0950632009	EL-063/080 Oppheng
W0951002009	EL-100/125 Oppheng

MAGNETFØLER

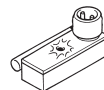
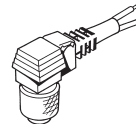

W0950000201	DSM2-C525 NO Reedkontakt
W0950000222	PNP DSM3-N225 Hallkontakt
W0950000232	NPN DSM3-M225 Hallkontakt

FESTEBØYLE FOR MAGNETFØLER



W0950000711	DST80 D.32/40 Festebøyle
W0950000712	DST81 D.50/63 Festebøyle
W0950000713	DST82 D.80/100/125 Festebøyle

KOMPAKTSYLINDERE



Artikkelnr.	Benevnelse
-------------	------------

KOMPAKTSYLINDER Ø12 ENKELVIRKENDE

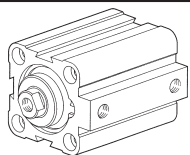

Enkelvirkende, pakninger NBR	
UTEN MAGNET	
2080120005CN	2080120005CN Sylinder
2080120010CN	2080120010CN Sylinder
2080120015CN	2080120015CN Sylinder
2080120020CN	2080120020CN Sylinder
2080120025CN	2080120025CN Sylinder
MED MAGNET	
2100120005CN	2100120005CN Sylinder
2100120010CN	2100120010CN Sylinder
2100120015CN	2100120015CN Sylinder
2100120020CN	2100120020CN Sylinder
2100120025CN	2100120025CN Sylinder
Enkelvirkende, pakninger Polyuretan	
UTEN MAGNET	
2080120005CP	2080120005CP Sylinder
2080120010CP	2080120010CP Sylinder
2080120015CP	2080120015CP Sylinder
2080120020CP	2080120020CP Sylinder
2080120025CP	2080120025CP Sylinder
MED MAGNET	
2100120005CP	2100120005CP Sylinder
2100120010CP	2100120010CP Sylinder
2100120015CP	2100120015CP Sylinder
2100120020CP	2100120020CP Sylinder
2100120025CP	2100120025CP Sylinder

KOMPAKTSYLINDER Ø16 ENKELVIRKENDE

Enkelvirkende, pakninger NBR	
UTEN MAGNET	
2080160005CN	2080160005CN Sylinder
2080160010CN	2080160010CN Sylinder
2080160015CN	2080160015CN Sylinder
2080160020CN	2080160020CN Sylinder
2080160025CN	2080160025CN Sylinder
MED MAGNET	
2100160005CN	2100160005CN Sylinder
2100160010CN	2100160010CN Sylinder
2100160015CN	2100160015CN Sylinder
2100160020CN	2100160020CN Sylinder
2100160025CN	2100160025CN Sylinder
Enkelvirkende, pakninger Polyuretan	
UTEN MAGNET	
2080160005CP	2080160005CP Sylinder
2080160010CP	2080160010CP Sylinder
2080160015CP	2080160015CP Sylinder
2080160020CP	2080160020CP Sylinder
2080160025CP	2080160025CP Sylinder
MED MAGNET	
2100160005CP	2100160005CP Sylinder
2100160010CP	2100160010CP Sylinder
2100160015CP	2100160015CP Sylinder
2100160020CP	2100160020CP Sylinder
2100160025CP	2100160025CP Sylinder

Artikkelnr.	Benevnelse
-------------	------------

KOMPAKTSYLINDER Ø20 ENKELVIRKENDE

Enkelvirkende, pakninger NBR	
UTEN MAGNET	
2080200005CN	2080200005CN Sylinder
2080200010CN	2080200010CN Sylinder
2080200015CN	2080200015CN Sylinder
2080200020CN	2080200020CN Sylinder
2080200025CN	2080200025CN Sylinder
MED MAGNET	
2100200005CN	2100200005CN Sylinder
2100200010CN	2100200010CN Sylinder
2100200015CN	2100200015CN Sylinder
2100200020CN	2100200020CN Sylinder
2100200025CN	2100200025CN Sylinder
Enkelvirkende, pakninger Polyuretan	
UTEN MAGNET	
2080200005CP	2080200005CP Sylinder
2080200010CP	2080200010CP Sylinder
2080200015CP	2080200015CP Sylinder
2080200020CP	2080200020CP Sylinder
2080200025CP	2080200025CP Sylinder
MED MAGNET	
2100200005CP	2100200005CP Sylinder
2100200010CP	2100200010CP Sylinder
2100200015CP	2100200015CP Sylinder
2100200020CP	2100200020CP Sylinder
2100200025CP	2100200025CP Sylinder

KOMPAKTSYLINDER Ø25 ENKELVIRKENDE

Enkelvirkende, pakninger NBR	
UTEN MAGNET	
2080250005CN	2080250005CN Sylinder
2080250010CN	2080250010CN Sylinder
2080250015CN	2080250015CN Sylinder
2080250020CN	2080250020CN Sylinder
2080250025CN	2080250025CN Sylinder
MED MAGNET	
2100250005CN	2100250005CN Sylinder
2100250010CN	2100250010CN Sylinder
2100250015CN	2100250015CN Sylinder
2100250020CN	2100250020CN Sylinder
2100250025CN	2100250025CN Sylinder
Enkelvirkende, pakninger Polyuretan	
UTEN MAGNET	
2080250005CP	2080250005CP Sylinder
2080250010CP	2080250010CP Sylinder
2080250015CP	2080250015CP Sylinder
2080250020CP	2080250020CP Sylinder
2080250025CP	2080250025CP Sylinder
MED MAGNET	
2100250005CP	2100250005CP Sylinder
2100250010CP	2100250010CP Sylinder
2100250015CP	2100250015CP Sylinder
2100250020CP	2100250020CP Sylinder
2100250025CP	2100250025CP Sylinder



Artikkelnr.	Benevnelse
-------------	------------

KOMPAKTSYLINDER Ø32 ENKELVIRKENDE

Enkelvirkende, pakninger NBR	
UTEN MAGNET	
2080320005CP	2080320005CP Sylinder
2080320010CP	2080320010CP Sylinder
2080320015CP	2080320015CP Sylinder
2080320020CP	2080320020CP Sylinder
2080320025CP	2080320025CP Sylinder
2080320030CP	2080320030CP Sylinder
2080320040CP	2080320040CP Sylinder
2080320050CP	2080320050CP Sylinder
MED MAGNET	
2100320010CN	2100320010CN Sylinder
2100320015CN	2100320015CN Sylinder
2100320020CN	2100320020CN Sylinder
2100320025CN	2100320025CN Sylinder
2100320030CN	2100320030CN Sylinder
2100320040CN	2100320040CN Sylinder
2100320050CN	2100320050CN Sylinder

Enkelvirkende, pakninger POLYURETAN

UTEN MAGNET	
2080320005CP	2080320005CP Sylinder
2080320010CP	2080320010CP Sylinder
2080320015CP	2080320015CP Sylinder
2080320020CP	2080320020CP Sylinder
2080320025CP	2080320025CP Sylinder
2080320030CP	2080320030CP Sylinder
2080320040CP	2080320040CP Sylinder
2080320050CP	2080320050CP Sylinder
MED MAGNET	
2100320005CP	2100320005CP Sylinder
2100320010CP	2100320010CP Sylinder
2100320015CP	2100320015CP Sylinder
2100320020CP	2100320020CP Sylinder
2100320025CP	2100320025CP Sylinder
2100320030CP	2100320030CP Sylinder
2100320040CP	2100320040CP Sylinder
2100320050CP	2100320050CP Sylinder

Artikkelnr.	Benevnelse
-------------	------------

KOMPAKTSYLINDER Ø40 ENKELVIRKENDE

Enkelvirkende, pakninger NBR	
UTEN MAGNET	
2080400005CN	2080400005CN Sylinder
2080400010CN	2080400010CN Sylinder
2080400015CN	2080400015CN Sylinder
2080400020CN	2080400020CN Sylinder
2080400025CN	2080400025CN Sylinder
2080400030CN	2080400030CN Sylinder
2080400040CN	2080400040CN Sylinder
2080400050CN	2080400050CN Sylinder
MED MAGNET	
2100400005CN	2100400005CN Sylinder
2100400010CN	2100400010CN Sylinder
2100400015CN	2100400015CN Sylinder
2100400020CN	2100400020CN Sylinder
2100400025CN	2100400025CN Sylinder
2100400030CN	2100400030CN Sylinder
2100400040CN	2100400040CN Sylinder
2100400050CN	2100400050CN Sylinder

Enkelvirkende, pakninger POLYURETAN

UTEN MAGNET	
2080400005CP	2080400005CP Sylinder
2080400010CP	2080400010CP Sylinder
2080400015CP	2080400015CP Sylinder
2080400020CP	2080400020CP Sylinder
2080400025CP	2080400025CP Sylinder
2080400030CP	2080400030CP Sylinder
2080400040CP	2080400040CP Sylinder
2080400050CP	2080400050CP Sylinder
MED MAGNET	
2100400005CP	2100400005CP Sylinder
2100400010CP	2100400010CP Sylinder
2100400015CP	2100400015CP Sylinder
2100400020CP	2100400020CP Sylinder
2100400025CP	2100400025CP Sylinder
2100400030CP	2100400030CP Sylinder
2100400040CP	2100400040CP Sylinder
2100400050CP	2100400050CP Sylinder



Artikkelnr.	Benevnelse
-------------	------------

KOMPAKTSYLINDER Ø50 ENKELVIRKENDE

Enkelvirkende, pakninger NBR	
UTEN MAGNET	
2080500005CN	2080500005CN Sylinder
2080500010CN	2080500010CN Sylinder
2080500015CN	2080500015CN Sylinder
2080500020CN	2080500020CN Sylinder
2080500025CN	2080500025CN Sylinder
2080500030CN	2080500030CN Sylinder
2080500040CN	2080500040CN Sylinder
2080500050CN	2080500050CN Sylinder
MED MAGNET	
2100500005CN	2100500005CN Sylinder
2100500010CN	2100500010CN Sylinder
2100500015CN	2100500015CN Sylinder
2100500020CN	2100500020CN Sylinder
2100500025CN	2100500025CN Sylinder
2100500030CN	2100500030CN Sylinder
2100500040CN	2100500040CN Sylinder
2100500050CN	2100500050CN Sylinder
Enkelvirkende, pakninger POLYURETAN	
UTEN MAGNET	
2080500005CP	2080500005CP Sylinder
2080500010CP	2080500010CP Sylinder
2080500015CP	2080500015CP Sylinder
2080500020CP	2080500020CP Sylinder
2080500025CP	2080500025CP Sylinder
2080500030CP	2080500030CP Sylinder
2080500040CP	2080500040CP Sylinder
2080500050CP	2080500050CP Sylinder
MED MAGNET	
2100500005CP	2100500005CP Sylinder
2100500010CP	2100500010CP Sylinder
2100500015CP	2100500015CP Sylinder
2100500020CP	2100500020CP Sylinder
2100500025CP	2100500025CP Sylinder
2100500030CP	2100500030CP Sylinder
2100500040CP	2100500040CP Sylinder
2100500050CP	2100500050CP Sylinder

Artikkelnr.	Benevnelse
-------------	------------

KOMPAKTSYLINDER Ø63 ENKELVIRKENDE

Enkelvirkende, pakninger NBR	
UTEN MAGNET	
2080630005CN	2080630005CN Sylinder
2080630010CN	2080630010CN Sylinder
2080630015CN	2080630015CN Sylinder
2080630020CN	2080630020CN Sylinder
2080630025CN	2080630025CN Sylinder
2080630030CN	2080630030CN Sylinder
2080630040CN	2080630040CN Sylinder
2080630050CN	2080630050CN Sylinder
MED MAGNET	
2100630005CN	2100630005CN Sylinder
2100630010CN	2100630010CN Sylinder
2100630015CN	2100630015CN Sylinder
2100630020CN	2100630020CN Sylinder
2100630025CN	2100630025CN Sylinder
2100630030CN	2100630030CN Sylinder
2100630040CN	2100630040CN Sylinder
2100630050CN	2100630050CN Sylinder
Enkelvirkende, pakninger POLYURETAN	
UTEN MAGNET	
2080630005CP	2080630005CP Sylinder
2080630010CP	2080630010CP Sylinder
2080630015CP	2080630015CP Sylinder
2080630020CP	2080630020CP Sylinder
2080630025CP	2080630025CP Sylinder
2080630030CP	2080630030CP Sylinder
2080630040CP	2080630040CP Sylinder
2080630050CP	2080630050CP Sylinder
MED MAGNET	
2100630005CP	2100630005CP Sylinder
2100630010CP	2100630010CP Sylinder
2100630015CP	2100630015CP Sylinder
2100630020CP	2100630020CP Sylinder
2100630025CP	2100630025CP Sylinder
2100630030CP	2100630030CP Sylinder
2100630040CP	2100630040CP Sylinder
2100630050CP	2100630050CP Sylinder



Artikkelnr.	Benevnelse
-------------	------------

KOMPAKTSYLINDER Ø12 DOBBELTVIRKENDE

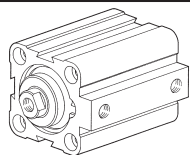

Dobbeltvirkende, pakninger NBR

UTEN MAGNET

2130120005CN	2130120005CN Sylinder
2130120010CN	2130120010CN Sylinder
2130120025CN	2130120025CN Sylinder
2130120030CN	2130120030CN Sylinder
2130120040CN	2130120040CN Sylinder

MED MAGNET

2120120005CN	2120120005CN Sylinder
2120120010CN	2120120010CN Sylinder
2120120025CN	2120120025CN Sylinder
2120120030CN	2120120030CN Sylinder
2120120040CN	2120120040CN Sylinder

Dobbeltvirkende, pakninger POLYURETAN

UTEN MAGNET

2130120005CP	2130120005CP Sylinder
2130120010CP	2130120010CP Sylinder
2130120025CP	2130120025CP Sylinder
2130120030CP	2130120030CP Sylinder
2130120040CP	2130120040CP Sylinder

MED MAGNET

2120120005CP	2120120005CP Sylinder
2120120010CP	2120120010CP Sylinder
2120120025CP	2120120025CP Sylinder
2120120030CP	2120120030CP Sylinder
2120120040CP	2120120040CP Sylinder

KOMPAKTSYLINDER Ø16 DOBBELTVIRKENDE

Dobbeltvirkende, pakninger NBR

UTEN MAGNET

2130160005CN	2130160005CN Sylinder
2130160010CN	2130160010CN Sylinder
2130160025CN	2130160025CN Sylinder
2130160030CN	2130160030CN Sylinder
2130160040CN	2130160040CN Sylinder

MED MAGNET

2120160005CN	2120160005CN Sylinder
2120160010CN	2120160010CN Sylinder
2120160025CN	2120160025CN Sylinder
2120160030CN	2120160030CN Sylinder
2120160040CN	2120160040CN Sylinder

Dobbeltvirkende, pakninger POLYURETAN

UTEN MAGNET

2130160005CP	2130160005CP Sylinder
2130160010CP	2130160010CP Sylinder
2130160025CP	2130160025CP Sylinder
2130160030CP	2130160030CP Sylinder
2130160040CP	2130160040CP Sylinder

MED MAGNET

2120160005CP	2120160005CP Sylinder
2120160010CP	2120160010CP Sylinder
2120160025CP	2120160025CP Sylinder
2120160030CP	2120160030CP Sylinder
2120160040CP	2120160040CP Sylinder

Artikkelnr.	Benevnelse
-------------	------------

KOMPAKTSYLINDER Ø20 DOBBELTVIRKENDE

Dobbeltvirkende, pakninger NBR

UTEN MAGNET

2130200005CN	2130200005CN Sylinder
2130200010CN	2130200010CN Sylinder
2130200025CN	2130200025CN Sylinder
2130200030CN	2130200030CN Sylinder
2130200040CN	2130200040CN Sylinder
2130200050CN	2130200050CN Sylinder

MED MAGNET

2120200005CN	2120200005CN Sylinder
2120200010CN	2120200010CN Sylinder
2120200025CN	2120200025CN Sylinder
2120200030CN	2120200030CN Sylinder
2120200040CN	2120200040CN Sylinder
2120200050CN	2120200050CN Sylinder

Dobbeltvirkende, pakninger POLYURETAN

UTEN MAGNET

2130200005CP	2130200005CP Sylinder
2130200010CP	2130200010CP Sylinder
2130200025CP	2130200025CP Sylinder
2130200030CP	2130200030CP Sylinder
2130200040CP	2130200040CP Sylinder
2130200050CP	2130200050CP Sylinder

MED MAGNET

2120200005CP	2120200005CP Sylinder
2120200010CP	2120200010CP Sylinder
2120200025CP	2120200025CP Sylinder
2120200030CP	2120200030CP Sylinder
2120200040CP	2120200040CP Sylinder
2120200050CP	2120200050CP Sylinder

KOMPAKTSYLINDER Ø25 DOBBELTVIRKENDE

Dobbeltvirkende, pakninger NBR

UTEN MAGNET

2130250005CN	2130250005CN Sylinder
2130250010CN	2130250010CN Sylinder
2130250025CN	2130250025CN Sylinder
2130250030CN	2130250030CN Sylinder
2130250040CN	2130250040CN Sylinder
2130250050CN	2130250050CN Sylinder

MED MAGNET

2120250005CN	2120250005CN Sylinder
2120250010CN	2120250010CN Sylinder
2120250025CN	2120250025CN Sylinder
2120250030CN	2120250030CN Sylinder
2120250040CN	2120250040CN Sylinder
2120250050CN	2120250050CN Sylinder

Dobbeltvirkende, pakninger POLYURETAN

UTEN MAGNET

2130250005CP	2130250005CP Sylinder
2130250010CP	2130250010CP Sylinder
2130250025CP	2130250025CP Sylinder
2130250030CP	2130250030CP Sylinder
2130250040CP	2130250040CP Sylinder
2130250050CP	2130250050CP Sylinder

MED MAGNET

2120250005CP	2120250005CP Sylinder
2120250010CP	2120250010CP Sylinder
2120250025CP	2120250025CP Sylinder
2120250030CP	2120250030CP Sylinder
2120250040CP	2120250040CP Sylinder
2120250050CP	2120250050CP Sylinder



Artikkelnr.	Benevnelse
-------------	------------

KOMPAKTSYLINDER Ø32 DOBBELTVIRKENDE

Dobbeltvirkende, pakninger NBR	
UTEN MAGNET	
2130320005CN	2130320005CN Sylinder
2130320010CN	2130320010CN Sylinder
2130320025CN	2130320025CN Sylinder
2130320030CN	2130320030CN Sylinder
2130320040CN	2130320040CN Sylinder
2130320050CN	2130320050CN Sylinder
MED MAGNET	
2120320005CN	2120320005CN Sylinder
2120320010CN	2120320010CN Sylinder
2120320025CN	2120320025CN Sylinder
2120320030CN	2120320030CN Sylinder
2120320040CN	2120320040CN Sylinder
2120320050CN	2120320050CN Sylinder
Dobbeltvirkende, pakninger POLYURETAN	
UTEN MAGNET	
2130320005CP	2130320005CP Sylinder
2130320010CP	2130320010CP Sylinder
2130320025CP	2130320025CP Sylinder
2130320030CP	2130320030CP Sylinder
2130320040CP	2130320040CP Sylinder
2130320050CP	2130320050CP Sylinder
MED MAGNET	
2120320005CP	2120320005CP Sylinder
2120320010CP	2120320010CP Sylinder
2120320025CP	2120320025CP Sylinder
2120320030CP	2120320030CP Sylinder
2120320040CP	2120320040CP Sylinder
2120320050CP	2120320050CP Sylinder

KOMPAKTSYLINDER Ø40 DOBBELTVIRKENDE

Dobbeltvirkende, pakninger NBR	
UTEN MAGNET	
2130400005CN	2130400005CN Sylinder
2130400010CN	2130400010CN Sylinder
2130400025CN	2130400025CN Sylinder
2130400030CN	2130400030CN Sylinder
2130400040CN	2130400040CN Sylinder
2130400050CN	2130400050CN Sylinder
MED MAGNET	
2120400005CN	2120400005CN Sylinder
2120400010CN	2120400010CN Sylinder
2120400025CN	2120400025CN Sylinder
2120400030CN	2120400030CN Sylinder
2120400040CN	2120400040CN Sylinder
2120400050CN	2120400050CN Sylinder
Dobbeltvirkende, pakninger POLYURETAN	
UTEN MAGNET	
2130400005CP	2130400005CP Sylinder
2130400010CP	2130400010CP Sylinder
2130400025CP	2130400025CP Sylinder
2130400030CP	2130400030CP Sylinder
2130400040CP	2130400040CP Sylinder
2130400050CP	2130400050CP Sylinder
MED MAGNET	
2120400005CP	2120400005CP Sylinder
2120400010CP	2120400010CP Sylinder
2120400025CP	2120400025CP Sylinder
2120400030CP	2120400030CP Sylinder
2120400040CP	2120400040CP Sylinder
2120400050CP	2120400050CP Sylinder

Artikkelnr.	Benevnelse
-------------	------------

KOMPAKTSYLINDER Ø50 DOBBELTVIRKENDE

Dobbeltvirkende, pakninger NBR	
UTEN MAGNET	
2130500005CN	2130500005CN Sylinder
2130500010CN	2130500010CN Sylinder
2130500030CN	2130500030CN Sylinder
2130500040CN	2130500040CN Sylinder
2130500050CN	2130500050CN Sylinder
2130500075CN	2130500075CN Sylinder
MED MAGNET	
2120500005CN	2120500005CN Sylinder
2120500010CN	2120500010CN Sylinder
2120500030CN	2120500030CN Sylinder
2120500040CN	2120500040CN Sylinder
2120500050CN	2120500050CN Sylinder
2120500075CN	2120500075CN Sylinder
Dobbeltvirkende, pakninger POLYURETAN	
UTEN MAGNET	
2130500005CP	2130500005CP Sylinder
2130500010CP	2130500010CP Sylinder
2130500030CP	2130500030CP Sylinder
2130500040CP	2130500040CP Sylinder
2130500050CP	2130500050CP Sylinder
2130500075CP	2130500075CP Sylinder
MED MAGNET	
2120500005CP	2120500005CP Sylinder
2120500010CP	2120500010CP Sylinder
2120500030CP	2120500030CP Sylinder
2120500040CP	2120500040CP Sylinder
2120500050CP	2120500050CP Sylinder
2120500075CP	2120500075CP Sylinder



Artikkelnr.	Benevnelse
-------------	------------

KOMPAKTSYLINDER Ø63 DOBBELTVIRKENDE

Dobbeltvirkende, pakninger NBR	
UTEN MAGNET	
2130630005CN	2130630005CN Sylinder
2130630010CN	2130630010CN Sylinder
2130630025CN	2130630025CN Sylinder
2130630030CN	2130630030CN Sylinder
2130630040CN	2130630040CN Sylinder
2130630050CN	2130630050CN Sylinder
2130630075CN	2130630075CN Sylinder
MED MAGNET	
2120630005CN	2120630005CN Sylinder
2120630010CN	2120630010CN Sylinder
2120630025CN	2120630025CN Sylinder
2120630030CN	2120630030CN Sylinder
2120630040CN	2120630040CN Sylinder
2120630050CN	2120630050CN Sylinder
2120630075CN	2120630075CN Sylinder
Dobbeltvirkende, pakninger POLYURETAN	
UTEN MAGNET	
2130630005CP	2130630005CP Sylinder
2130630010CP	2130630010CP Sylinder
2130630025CP	2130630025CP Sylinder
2130630030CP	2130630030CP Sylinder
2130630040CP	2130630040CP Sylinder
2130630050CP	2130630050CP Sylinder
2130630075CP	2130630075CP Sylinder
MED MAGNET	
2120630005CP	2120630005CP Sylinder
2120630010CP	2120630010CP Sylinder
2120630025CP	2120630025CP Sylinder
2120630030CP	2120630030CP Sylinder
2120630040CP	2120630040CP Sylinder
2120630050CP	2120630050CP Sylinder
2120630075CP	2120630075CP Sylinder

Artikkelnr.	Benevnelse
-------------	------------

KOMPAKTSYLINDER Ø80 DOBBELTVIRKENDE

Dobbeltvirkende, pakninger NBR	
UTEN MAGNET	
2130800005AN	2130800005AN Sylinder
2130800010AN	2130800010AN Sylinder
2130800025AN	2130800025AN Sylinder
2130800030AN	2130800030AN Sylinder
2130800040AN	2130800040AN Sylinder
2130800050AN	2130800050AN Sylinder
2130800075AN	2130800075AN Sylinder
2130800100AN	2130800100AN Sylinder
MED MAGNET	
2120800005AN	2120800005AN Sylinder
2120800010AN	2120800010AN Sylinder
2120800025AN	2120800025AN Sylinder
2120800030AN	2120800030AN Sylinder
2120800040AN	2120800040AN Sylinder
2120800050AN	2120800050AN Sylinder
2120800075AN	2120800075AN Sylinder
2120800100AN	2120800100AN Sylinder
Dobbeltvirkende, pakninger NBR	
UTEN MAGNET	
2130800005AP	2130800005AP Sylinder
2130800010AP	2130800010AP Sylinder
2130800025AP	2130800025AP Sylinder
2130800030AP	2130800030AP Sylinder
2130800040AP	2130800040AP Sylinder
2130800050AP	2130800050AP Sylinder
2130800075AP	2130800075AP Sylinder
2130800100AP	2130800100AP Sylinder
MED MAGNET	
2120800005AP	2120800005AP Sylinder
2120800010AP	2120800010AP Sylinder
2120800025AP	2120800025AP Sylinder
2120800030AP	2120800030AP Sylinder
2120800040AP	2120800040AP Sylinder
2120800050AP	2120800050AP Sylinder
2120800075AP	2120800075AP Sylinder
2120800100AP	2120800100AP Sylinder

TILBEHØR KOMPAKTSYLINDERE

Artikkelnr.	Benevnelse
-------------	------------

KOMPAKTSYLINDER Ø100 DOBBELTVIRKENDE

Dobbeltvirkende, pakninger NBR

UTEN MAGNET

2131000005AN	2131000005AN Sylinder
2131000010AN	2131000010AN Sylinder
2131000025AN	2131000025AN Sylinder
2131000030AN	2131000030AN Sylinder
2131000040AN	2131000040AN Sylinder
2131000050AN	2131000050AN Sylinder
2131000075AN	2131000075AN Sylinder
2131000100AN	2131000100AN Sylinder

MED MAGNET

2121000005AN	2121000005AN Sylinder
2121000010AN	2121000010AN Sylinder
2121000025AN	2121000025AN Sylinder
2121000030AN	2121000030AN Sylinder
2121000040AN	2121000040AN Sylinder
2121000050AN	2121000050AN Sylinder
2121000075AN	2121000075AN Sylinder
2121000100AN	2121000100AN Sylinder

Dobbeltvirkende, pakninger POLYURETAN

UTEN MAGNET

2131000005AP	2131000005AP Sylinder
2131000010AP	2131000010AP Sylinder
2131000025AP	2131000025AP Sylinder
2131000030AP	2131000030AP Sylinder
2131000040AP	2131000040AP Sylinder
2131000050AP	2131000050AP Sylinder
2131000075AP	2131000075AP Sylinder
2131000100AP	2131000100AP Sylinder

MED MAGNET

2121000005AP	2121000005AP Sylinder
2121000010AP	2121000010AP Sylinder
2121000025AP	2121000025AP Sylinder
2121000030AP	2121000030AP Sylinder
2121000040AP	2121000040AP Sylinder
2121000050AP	2121000050AP Sylinder
2121000075AP	2121000075AP Sylinder
2121000100AP	2121000100AP Sylinder

OBS!

MAXSLAGLENGDE	12	16	20	25	32	40	50	63	80	100
ENKELTVIRKENDE	25	25	25	25	50	50	50	50	/	/
DOBBELTVIRKENDE	50	50	50	70	70	70	110	110	150	150

For slaglengder lengere en angitt, kontakt vår salgsavdeling.

Artikkelnr.	Benevnelse
-------------	------------

NIPPEL FOR STEMPELSTANG (UTV. GJ.)



219001200	Nippel M6 for CBW Ø12
219001600	Nippel M8 for CBW Ø16/20
219002500	Nippel M10x1,25 for CBW Ø25
219003200	Nippel M10x1,25 for CBW Ø32
219004000	Nippel M12x1,25 for CBW Ø40
219005000	Nippel M16x1,5 for CBW Ø50/63
219008000	Nippel M20x1,5 for CBW Ø80
219010000	Nippel M20x1,5 for CBW Ø100

MAGNETFØLER (komplett med fester)

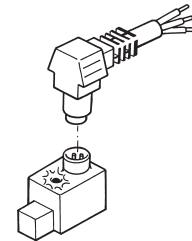

W0950000253	PNP DCB3N-225 Hallkontakt
W0950000252	DCB2C-425 Reedkontakt



RESERVEDELER KOMPAKTSYLINDERE

Artikkelnr.	Benevnelse
-------------	------------

RESERVEDELER NBR Ø12

0090120001	Magnet CB Ø12
0090120006	Pakningssett CBW Ø12 NBR
0090120011	Gavlesett fremre CB-DE Ø12 NBR
0090120015	Gavlesett bakre CB-DE Ø12 PU
0090120023	Stempelstangsett med pakning Ø12 NBR

RESERVEDELER NBR Ø16

0090160001	Magnet CB Ø16
0090160006	Tätningssats CBW Ø16 NBR
0090160011	Gavlesett fremre CB-DE Ø16 NBR
0090160023	Stempelstangsett med pakning Ø NBR

RESERVEDELER NBR Ø20

0090200001	Magnet CB Ø20
0090200006	Tätningssats CBW Ø20 NBR
0090200011	Gavlesatt främre CB-DE Ø20 NBR
0090200023	Stempelstangsett med pakning Ø20 NBR

RESERVEDELER NBR Ø25

0090250001	Magnet CB Ø25
0090250006	Tätningssats CBW Ø25 NBR
0090250011	Gavlesett fremre CB-DE Ø25 NBR
0090250023	Stempelstangsett med pakning Ø25 NBR

RESERVEDELER NBR Ø32

0090320001	Magnet CB Ø32
0090320006	Tätningssats CBW Ø32 NBR
0090320011	Gavlesett fremre CB-DE Ø32 NBR
0090320023	Stempelstangsett med pakning Ø32 NBR

RESERVEDELER NBR Ø40

0090400001	Magnet CB Ø40
0090400006	Pakningssett CBW Ø40 NBR
0090400011	Gavlesett fremre CB-DE Ø40 NBR
0090400023	Stempelstangsett med pakning Ø40 NBR

Artikkelnr.	Benevnelse
-------------	------------

RESERVEDELER POLYURETAN Ø12

0090120001	Magnet CB Ø12
0090120005	Pakningssett CBW Ø12 PU
0090120010	Gavlesett fremre CB-DE Ø12 PU
0090120015	Gavlesett bakre CB-DE Ø12 PU
0090120021	Stempelstangsett med pakning Ø12 PU
0090120033	Komplett sett CB-DE Ø12 NBR

RESERVEDELER POLYURETAN Ø16

0090160001	Magnet CB Ø16
0090160005	Pakningssett CBW Ø16 PU
0090160010	Gavlesett fremre CB-DE Ø16 PU
0090160015	Gavlesett bakre CB-DE Ø16 PU
0090160021	Stempelstangsett med pakning Ø16 PU

RESERVEDELER POLYURETAN Ø20

0090200001	Magnet CB Ø20
0090200005	Pakningssett CBW Ø20 PU
0090200010	Gavlesett fremre CB-DE Ø20 PU
0090200015	Gavlesett bakre CB-DE Ø20 PU
0090200021	Stempelstangsett med pakning Ø20 PU

RESERVEDELER POLYURETAN Ø25

0090250001	Magnet CB Ø25
0090250005	Pakningssett CBW Ø25 PU
0090250010	Gavlesett fremre CB-DE Ø25 PU
0090250015	Gavlesett bakre CB-DE Ø25 PU
0090250021	Stempelstangsett med pakning Ø25 PU

RESERVEDELER POLYURETAN Ø32

0090320001	Magnet CB Ø32
0090320005	Pakningssett CBW Ø32 PU
0090320010	Gavlesett fremre CB-DE Ø32 PU
0090320015	Gavlesett bakre CB-DE Ø32 PU
0090320021	Stempelstangsett med pakning Ø32 PU

RESERVEDELER POLYURETAN Ø40

0090400001	Magnet CB Ø40
0090400005	Pakningssett CBW Ø40 PU
0090400010	Gavlesett fremre CB-DE Ø40 PU
0090400015	Gavlesett bakre CB-DE Ø40 PU
0090400021	Stempelstangsett med pakning Ø40 PU



Artikkelnr.	Benevnelse
-------------	------------

RESERVEDELER NBR Ø50

0090500001	Magnet CB Ø50
0090500006	Pakningsett CBW Ø50 NBR
0090500011	Gavlesett fremre CB-DE Ø50 NBR
0090500023	Stempelstangsett med pakning Ø50 NBR

RESERVEDELER NBR Ø63

0090630001	Magnet CB Ø63
0090630006	Tätningssats CBW Ø63 NBR
0090630011	Gavlesett fremre CB-DE Ø63 NBR
0090630023	Stempelstangsett med pakning Ø63 NBR

RESERVEDELER NBR Ø80

0090800001	Magnet CB Ø80
0090800006	Pakningsett CBW Ø80 NBR
0090800011	Gavlesett fremre CB-DE Ø80 NBR
0090800023	Stempelstangsett med pakning Ø80 NBR

RICAMBI NBR SSC Ø100

0091000001	Magnet CB Ø100
0091000006	Pakningsett CBW Ø100 NBR
0091000011	Gavlesett fremre CB-DE Ø100 NBR
0091000023	Stempelstangsett med pakning Ø100 NBR

Artikkelnr.	Benevnelse
-------------	------------

RESERVEDELER POLYURETAN Ø50

0090500001	Magnet CB Ø50
0090500005	Pakningsett CBW Ø50 PU
0090500010	Gavlesett fremre CB-DE Ø50 PU
0090500015	Gavlesett bakre CB-DE Ø50 PU
0090500021	Stempelstangsett med pakning Ø50 PU

RESERVEDELER POLYURETAN Ø63

0090630001	Magnet CB Ø63
0090630005	Pakningsett CBW Ø63 PU
0090630010	Gavlesett fremre CB-DE Ø63 PU
0090630015	Gavlesett bakre CB-DE Ø63
0090630021	Stempelstangsett med pakning Ø63 PU

RESERVEDELER POLYURETAN Ø80

0090800001	Magnet CB Ø80
0090800005	Pakningsett CBW Ø80 PU
0090800010	Gavlesett fremre CB-DE Ø80 PU
0090800015	Gavlesett bakre CB-DE Ø80
0090800021	Stempelstangsett med pakning Ø80 PU

RESERVEDELER POLYURETAN Ø100

0091000001	Magnet CB Ø100
0091000005	Pakningsett CBW Ø100 PU
0091000010	Gavlesett fremre CB-DE Ø100 PU
0091000015	Gavlesett bakre CB-DE Ø100
0091000021	Stempelstangsett med pakning Ø100 PU

cod. 211.....	Enkelvirkende, omvent
cod. 214.....	Gjennomgående stempelstang
cod. 217.....	Vristiv utførelse (ANRT)
cod. 218.....	Gjennomgående stempelstang innhul
cod. 223.....	Enkelvirkende, gjennomgående stemp.
cod. 222.....	Cyl. 212.... med montert svingfeste
cod. 221.....	Cyl. 212.... med montert svingfeste
cod. 228.....	Spesialutførelse

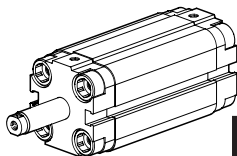

KOMPAKTSYLINDERE

Utførelse	Artikkelnr.	Ø12	Ø16	Ø20	Ø25
Dobbeltvirkende	-- 0				
Dobbeltvirkende gjennomgående stempels.	-- 1				
Enkelvirkende stempels. minusnivå	-- 3				
Enkelvirkende stempels. plussnivå	-- 4				
Enkelvirkende gjennomgående stempels.	-- 5				
Dobbeltvirkende vristiv	-- 7				
Dobbeltvirkende vristiv gjennomg. stempels.	-- A				
Dobbeltvirkende tandem dobbel kraft	-- 00 -- A				
Dobbeltvirkende tandem 3-dobbel kraft	-- 00 -- B				
Dobbeltvirkende tandem 4-dobbel kraft	-- 00 -- C				
Dobbeltvirkende multiposisjon steg 1	-- 00 -- P				
Dobbeltvirkende multiposisjon steg 2	-- 00 -- R				
Dobbeltvirkende multiposisjon steg 3	-- 00 -- T				
Rustfri stempelstang					
Utførelse uten magnet					

Artikkelnr.	Benevnelse
-------------	------------

FOTFESTE A

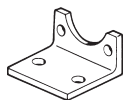

W0950126001	A-012/016 CMPC Fotfeste
W0950206001	A-020 CMPC Fotfeste
W0950256001	A-020 CMPC Fotfeste
W0950322001	A-032 Fotfeste
W0950406001	A-040 UNITOP Fotfeste
W0950506001	A-050 UNITOP Fotfeste
W0950636001	A-063 UNITOP Fotfeste
W0950806001	A-080 UNITOP Fotfeste
W0951006001	A-100 UNITOP Fotfeste

FOR ISO-FESTE, SE SID.23

SVINGFESTE B

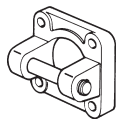

W0950322003	B-032 Svingfeste+tapp
W0950406003	B-040 UNITOP Svingfeste+tapp
W0950506003	B-050 UNITOP Svingfeste+tapp
W0950636003	B-063 UNITOP Svingfeste+tapp
W0950806003	B-080 UNITOP Svingfeste+tapp
W0951006003	B-100 UNITOP Svingfeste+tapp

For iso-feste se side 21

SVINGFESTE BA

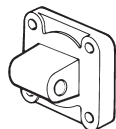

W0950126004	BA-012/016 CMPC Svingfeste
W0950206004	BA-020 CMPC Svingfeste
W0950256004	BA-025 CMPC Svingfeste

Artikkelnr.	Benevnelse
-------------	------------

FLENSFESTE C

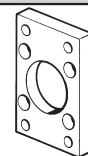

W0950126002	C-012/016 CMPC Flensfeste
W0950206002	C-020 CMPC Flensfeste
W0950256002	C-025 CMPC Flensfeste
W0950322002	C-032 Flensfeste
W0950406002	C-040 UNITOP Flensfeste
W0950506002	C-050 UNITOP Flensfeste
W0950636002	C-063 UNITOP Flensfeste
W0950806002	C-080 UNITOP Flensfeste
W0951006002	C-100 UNITOP Flensfeste

FLEXFESTE GA

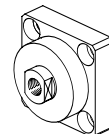

W0950326021	GA-032 Flexfeste
W0950406021	GA-040 Flexfeste
W0950506021	GA-050 Flexfeste

STEMPELSTANGENDE GA-K

W0950120030	GA-K-012 Stempelstangende CMPC
W0950200030	GA-K-020 Stempelstangende CMPC
	Kuleleddøre, se sid. 23
	Gaffelfeste, se sid. 24
	Kuleleddfeste, se sid. 24
	Vinkelfeste, se sid. 23

FLENS FOR GAVLEMONTERING

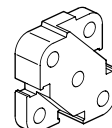

0950123060	Flens for Ø12 CMPC gavlemontering
0950203060	Flens for Ø20 CMPC gavlemontering.
0950253060	Flens for Ø25 CMPC gavlemontering.

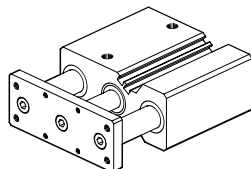

KOMPAKTGUIDER

Artikkelnr.	Benevnelse
-------------	------------

KOMPAKTGUIDE Ø 16 BRONSEBØSSING

W1430162010	Kompaktguide S6 Ø16-0010 bronseb.
W1430162020	Kompaktguide S6 Ø16-0020 bronseb.
W1430162030	Kompaktguide S6 Ø16-0030 bronseb.
W1430162040	Kompaktguide S6 Ø16-0040 bronseb.
W1430162050	Kompaktguide S6 Ø16-0050 bronseb.

KOMPAKTGUIDE Ø 20 BRONSEBØSSING

W1430202020	Kompaktguide S6 Ø20-0020 bronseb.
W1430202030	Kompaktguide S6 Ø20-0030 bronseb.
W1430202040	Kompaktguide S6 Ø20-0040 bronseb.
W1430202050	Kompaktguide S6 Ø20-0050 bronseb.
W1430202075	Kompaktguide S6 Ø20-0075 bronseb.
W1430202100	Kompaktguide S6 Ø20-0100 bronseb.

KOMPAKTGUIDE Ø 25 BRONSEBØSSING

W1430252020	Kompaktguide S6 Ø25-0020 bronseb.
W1430252025	Kompaktguide S6 Ø25-0025 bronseb.
W1430252030	Kompaktguide S6 Ø25-0030 bronseb.
W1430252040	Kompaktguide S6 Ø25-0040 bronseb.
W1430252050	Kompaktguide S6 Ø25-0050 bronseb.
W1430252075	Kompaktguide S6 Ø25-0075 bronseb.
W1430252100	Kompaktguide S6 Ø25-0100 bronseb.

KOMPAKTGUIDE Ø 32 BRONSEBØSSING

W1430322025	Kompaktguide S6 Ø32-0025 bronseb.
W1430322050	Kompaktguide S6 Ø32-0050 bronseb.
W1430322075	Kompaktguide S6 Ø32-0075 bronseb.
W1430322100	Kompaktguide S6 Ø32-0100 bronseb.

KOMPAKTGUIDE Ø 40 BRONSEBØSSING

W1430402025	Kompaktguide S6 Ø40-0025 bronseb.
W1430402050	Kompaktguide S6 Ø40-0050 bronseb.
W1430402075	Kompaktguide S6 Ø40-0075 bronseb.
W1430402100	Kompaktguide S6 Ø40-0100 bronseb.

KOMPAKTGUIDE Ø 50 BRONSEBØSSING

W1430502025	Kompaktguide S6 Ø50-0025 bronseb.
W1430502050	Kompaktguide S6 Ø50-0050 bronseb.
W1430502075	Kompaktguide S6 Ø50-0075 bronseb.
W1430502100	Kompaktguide S6 Ø50-0100 bronseb.

KOMPAKTGUIDE Ø 63 BRONSEBØSSING

W1430632025	Kompaktguide S6 Ø63-0025 bronseb.
W1430632050	Kompaktguide S6 Ø63-0050 bronseb.
W1430632075	Kompaktguide S6 Ø63-0075 bronseb.
W1430632100	Kompaktguide S6 Ø63-0100 bronseb.

KOMPAKTGUIDE Ø 80 BRONSEBØSSING

W1430802025	Kompaktguide S6 Ø80-0025 bronseb.
W1430802050	Kompaktguide S6 Ø80-0050 bronseb.
W1430802075	Kompaktguide S6 Ø80-0075 bronseb.
W1430802100	Kompaktguide S6 Ø80-0100 bronseb.

KOMPAKTGUIDE Ø 100 BRONSEBØSSING

W1430A12025	Kompaktguide S6 Ø100-0025 bronseb.
W1430A12050	Kompaktguide S6 Ø100-0050 bronseb.
W1430A12075	Kompaktguide S6 Ø100-0075 bronseb.
W1430A12100	Kompaktguide S6 Ø100-0100 bronseb.

Artikkelnr.	Benevnelse
-------------	------------

KOMPAKTGUIDE Ø 16 KULEBØSSING

W1430163010	Kompaktguide S6 Ø16-0010 kuleb.
W1430163020	Kompaktguide S6 Ø16-0020 kuleb.
W1430163030	Kompaktguide S6 Ø16-0030 kuleb.
W1430163040	Kompaktguide S6 Ø16-0040 kuleb.
W1430163050	Kompaktguide S6 Ø16-0050 kuleb.

KOMPAKTGUIDE Ø 20 KULEBØSSING

W1430203020	Kompaktguide S6 Ø20-0020 kuleb.
W1430203030	Kompaktguide S6 Ø20-0030 kuleb.
W1430203040	Kompaktguide S6 Ø20-0040 kuleb.
W1430203050	Kompaktguide S6 Ø20-0050 kuleb.
W1430203075	Kompaktguide S6 Ø20-0075 kuleb.
W1430203100	Kompaktguide S6 Ø20-0100 kuleb.

KOMPAKTGUIDE Ø 25 KULEBØSSING

W1430253020	Kompaktguide S6 Ø25-0020 kuleb.
W1430253025	Kompaktguide S6 Ø25-0025 kuleb.
W1430253030	Kompaktguide S6 Ø25-0030 kuleb.
W1430253040	Kompaktguide S6 Ø25-0040 kuleb.
W1430253050	Kompaktguide S6 Ø25-0050 kuleb.
W1430253075	Kompaktguide S6 Ø25-0075 kuleb.
W1430253100	Kompaktguide S6 Ø25-0100 kuleb.

KOMPAKTGUIDE Ø 32 KULEBØSSING

W1430323025	Kompaktguide S6 Ø32-0025 kuleb.
W1430323050	Kompaktguide S6 Ø32-0050 kuleb.
W1430323075	Kompaktguide S6 Ø32-0075 kuleb.
W1430323100	Kompaktguide S6 Ø32-0100 kuleb.

KOMPAKTGUIDE Ø 40 KULEBØSSING

W1430403025	Kompaktguide S6 Ø40-0025 kuleb.
W1430403050	Kompaktguide S6 Ø40-0050 kuleb.
W1430403075	Kompaktguide S6 Ø40-0075 kuleb.
W1430403100	Kompaktguide S6 Ø40-0100 kuleb.

KOMPAKTGUIDE Ø 50 KULEBØSSING

W1430503025	Kompaktguide S6 Ø50-0025 kuleb.
W1430503050	Kompaktguide S6 Ø50-0050 kuleb.
W1430503075	Kompaktguide S6 Ø50-0075 kuleb.
W1430503100	Kompaktguide S6 Ø50-0100 kuleb.

KOMPAKTGUIDE Ø 63 KULEBØSSING

W1430633025	Kompaktguide S6 Ø63-0025 kuleb.
W1430633050	Kompaktguide S6 Ø63-0050 kuleb.
W1430633075	Kompaktguide S6 Ø63-0075 kuleb.
W1430633100	Kompaktguide S6 Ø63-0100 kuleb.

KOMPAKTGUIDE Ø 80 KULEBØSSING

W1430803025	Kompaktguide S6 Ø80-0025 kuleb.
W1430803050	Kompaktguide S6 Ø80-0050 kuleb.
W1430803075	Kompaktguide S6 Ø80-0075 kuleb.
W1430803100	Kompaktguide S6 Ø80-0100 kuleb.

KOMPAKTGUIDE Ø 80 KULEBØSSING

W1430A13025	Kompaktguide S6 Ø100-0025 kuleb.
W1430A13050	Kompaktguide S6 Ø100-0050 kuleb.
W1430A13075	Kompaktguide S6 Ø100-0075 kuleb.
W1430A13100	Kompaktguide S6 Ø100-0100 kuleb.

TILBEHØR

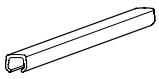
Artikkelnr.	Benevnelse
DEKKLIST FOR PROFILSPOR	
W0950000160	Dekklister for profilspor 500mm

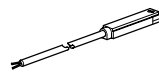
Artikkelnr.	Benevnelse
MAGNETFØLER	
W0950022180	DSL1-C225 NO Reedkontakt
W0950025390	DSL4-N225 NO Hallkontakt
W0950028184	DSL1-C2M8 300mm Reedkontakt
W0950029394	DSL4-N2M8 300mm Hallkontakt

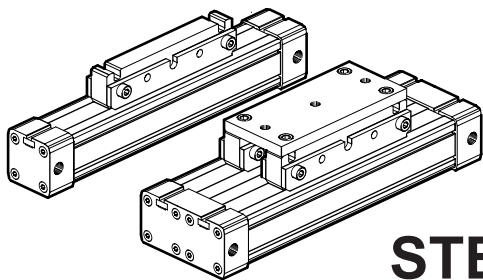

STEMPELSTANGLØSE SYLINDERE

Standardutførelse med NBR pakninger.

Standardutførelse	Ø 16	Ø 25	Ø 32	Ø 40

TILBEHØR

FOTFESTE

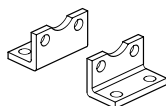

W0950167001	Fotfeste Ø16, Stempelstangløs syl.
W0950257001	Fotfeste Ø25, Stempelstangløs syl.

FOTFESTE

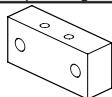

W0950327001	Fotfeste Ø32, Stempelstangløs syl.
W0950407001	Fotfeste Ø40, Stempelstangløs syl.

MIDJESTØTTE

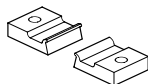

W0950167031	Midjestøtte Ø16, Stempelstangløs syl.
W0950257031	Midjestøtte Ø25, Stempelstangløs syl.

MIDJESTØTTE

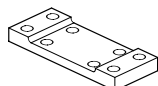

W0950327032	Midjestøtte Ø32, Stempelstangløs syl.
W0950407032	Midjestøtte Ø40, Stempelstangløs syl.

TILBEHØR

BOLT FOR VOGNFESTE

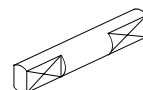

W0950167034	Bolt for Ø16 Stempelstangløs syl.
W0950257034	Bolt for Ø25 Stempelstangløs syl.
W0950327034	Bolt for Ø32 Stempelstangløs syl.

FESTE

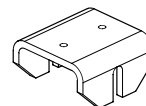

W0950167033	Feste Ø16, Stempelstangløs syl.
W0950257033	Feste Ø25, Stempelstangløs syl.
W0950327033	Feste Ø32, Stempelstangløs syl.

PARALLELLT FOTFESTE

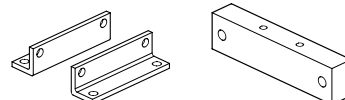

W0950168001	Parallellt Fotfeste Ø16
W0950258001	Parallellt Fotfeste Ø25
W0950328036	Parallellt Fotfeste Ø32



Artikkelnr.	Benevnelse
-------------	------------

VERTIKALFESTE

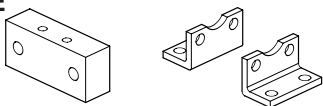

W0950328035 Vertikalfeste Ø32

PARALLELL MIDJESTØTTE

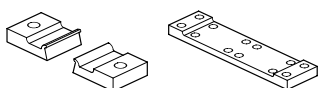

W0950168037 Parallell midjestøtte Ø16

W0950258037 Parallell midjestøtte Ø25

W0950328037 Parallell midjestøtte Ø32

SENSORFESTE

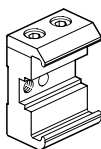

0950164001 Sensorfeste Ø16/25

DEKKLIST FOR PROFILSPOR

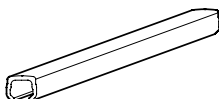

W0950000160 Dekklist for profilspor 500mm

MAGNETFØLER

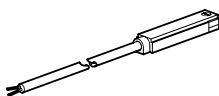

W0950022180 DSL1-C225 NO Reedkontakt

W0950025390 DSL4-N225 NO Hallkontakt

W0950028184 DSL1-C2M8 300mm Reedkontakt

W0950029394 DSL4-N2M8 300mm Hallkontakt

RESERVEDELER

Artikkelnr.	Benevnelse
-------------	------------

SETT GLIDESKINNE Ø 16

0090165001 sett glideskinne Ø16, hvit (0.9mm)

0090165002 sett glideskinne Ø16, grå (1.0mm)

0090165003 sett glideskinne Ø16, svart (1.1mm)

0090165004 sett glideskinne Ø16, rød (1.2mm)

SETT GLIDESKINNE Ø 25

0090255001 sett glideskinne Ø25, hvit (0.9mm)

0090255002 sett glideskinne Ø25, grå (1.0mm)

0090255003 sett glideskinne Ø25, svart (1.1mm)

0090255004 sett glideskinne Ø25, rød (1.2mm)

SETT GLIDESKINNE Ø 32+40

0090325001 sett glideskinne Ø32-40, hvit (0.9mm)

0090325002 sett glideskinne Ø32-40, grå (1.0mm)

0090325003 sett glideskinne Ø32-40, svart (1.1mm)

0090325004 sett glideskinne Ø32-40, rød (1.2mm)

STEMPELS. SETT Ø 16

0090165010 Stempels. sett Ø16, typ 0 (ingen ringer)

0090165011 Stempels. sett Ø16, typ 1 (en ring)

0090165012 Stempels. sett Ø16, typ 2 (to ringer)

0090165013 Stempels. sett Ø16, typ 3 (tre ringer)

STEMPELS. SETT Ø 25

0090255010 Stempels. sett Ø25, typ 0 (ingen ringer)

0090255011 Stempels. sett Ø25, typ 1 (en ring)

0090255012 Stempels. sett Ø25, typ 2 (to ringer)

0090255013 Stempels. sett Ø25, typ 3 (tre ringer)

STEMPELS. SETT Ø 32

0090325010 Stempels. sett Ø32, typ 0 (ingen ringer)

0090325011 Stempels. sett Ø32, typ 1 (en ring)

0090325012 Stempels. sett Ø32, typ 2 (to ringer)

0090325013 Stempels. sett Ø32, typ 3 (tre ringer)

STEMPELS. SETT Ø 40

0090405010 Stempels. sett Ø40, typ 0 (ingen ringer)

0090405011 Stempels. sett Ø40, typ 1 (en ring)

0090405012 Stempels. sett Ø40, typ 2 (to ringer)

0090405013 Stempels. sett Ø40, typ 3 (tre ringer)

PAKNINGSETT NBR

0090165020 Pakningsett Ø16 NBR stemp.s.løs

0090255020 Pakningsett Ø25 NBR stemp.s.løs

0090325020 Pakningsett Ø32 NBR stemp.s.løs

0090405020 Pakningsett Ø40 NBR stemp.s.løs

PAKNINGSETT VITON

0090165020 Pakningsett Ø16 VITON stemp.s.løs

0090255020 Pakningsett Ø25 VITON stemp.s.løs

0090325020 Pakningsett Ø32 VITON stemp.s.løs

0090405020 Pakningsett Ø40 VITON stemp.s.løs

SETT BÅND

Kontakt vår salgsavdeling

OLJEDEMPERE



Artikkelnr.	Benevnelse
-------------	------------

JUSTERBAR PLUSSBEVEGELSE

W1700010050	BRK-P 0050-STD Oljedempere
W1700010100	BRK-P 0100-STD Oljedempere
W1700010150	BRK-P 0150-STD Oljedempere
W1700010200	BRK-P 0200-STD Oljedempere
W1700010250	BRK-P 0250-STD Oljedempere
W1700010300	BRK-P 0300-STD Oljedempere
W1700010350	BRK-P 0350-STD Oljedempere
W1700010400	BRK-P 0400-STD Oljedempere

JUSTERBAR MINUSBEVEGELSE

W1700110050	BRK-N 0050-STD Oljedempere
W1700110100	BRK-N 0100-STD Oljedempere
W1700110150	BRK-N 0150-STD Oljedempere
W1700110200	BRK-N 0200-STD Oljedempere
W1700110250	BRK-N 0250-STD Oljedempere
W1700110300	BRK-N 0300-STD Oljedempere
W1700110350	BRK-N 0350-STD Oljedempere
W1700110400	BRK-N 0400-STD Oljedempere

JUSTERBAR BEGGE RETNINGER

W1700210050	BRK-D 0050-STD Oljedempere
W1700210100	BRK-D 0100-STD Oljedempere
W1700210150	BRK-D 0150-STD Oljedempere
W1700210200	BRK-D 0200-STD Oljedempere
W1700210250	BRK-D 0250-STD Oljedempere
W1700210300	BRK-D 0300-STD Oljedempere
W1700210350	BRK-D 0350-STD Oljedempere
W1700210400	BRK-D 0400-STD Oljedempere

JUSTERBAR PLUSSBEVEGELSE + SKIP VENTIL

W1701010050	BRK-P 0050-SKV Oljedempere
W1701010100	BRK-P 0100-SKV Oljedempere
W1701010150	BRK-P 0150-SKV Oljedempere
W1701010200	BRK-P 0200-SKV Oljedempere
W1701010250	BRK-P 0250-SKV Oljedempere
W1701010300	BRK-P 0300-SKV Oljedempere
W1701010350	BRK-P 0350-SKV Oljedempere
W1701010400	BRK-P 0400-SKV Oljedempere

JUSTERBAR MINUSBEVEGELSE + SKIP VENTIL

W1701110050	BRK-N 0050-SKV Oljedempere
W1701110100	BRK-N 0100-SKV Oljedempere
W1701110150	BRK-N 0150-SKV Oljedempere
W1701110200	BRK-N 0200-SKV Oljedempere
W1701110250	BRK-N 0250-SKV Oljedempere
W1701110300	BRK-N 0300-SKV Oljedempere
W1701110350	BRK-N 0350-SKV Oljedempere
W1701110400	BRK-N 0400-SKV Oljedempere

Artikkelnr.	Benevnelse
-------------	------------

JUSTERBAR PLUSSBEVEGELSE + STOP VENTIL

W1702010050	BRK-P 0050-STV Oljedempere
W1702010100	BRK-P 0100-STV Oljedempere
W1702010150	BRK-P 0150-STV Oljedempere
W1702010200	BRK-P 0200-STV Oljedempere
W1702010250	BRK-P 0250-STV Oljedempere
W1702010300	BRK-P 0300-STV Oljedempere
W1702010350	BRK-P 0350-STV Oljedempere
W1702010400	BRK-P 0400-STV Oljedempere

JUSTERBAR MINUSBEVEGELSE + STOP VENTIL

W1702110050	BRK-N 0050-STV Oljedempere
W1702110100	BRK-N 0100-STV Oljedempere
W1702110150	BRK-N 0150-STV Oljedempere
W1702110200	BRK-N 0200-STV Oljedempere
W1702110250	BRK-N 0250-STV Oljedempere
W1702110300	BRK-N 0300-STV Oljedempere
W1702110350	BRK-N 0350-STV Oljedempere
W1702110400	BRK-N 0400-STV Oljedempere

JUSTERBAR PLUSSBEVEGELSE + SKIP OG STOP VENTIL

W1703010050	BRK-P 0050-SKT Oljedempere
W1703010100	BRK-P 0100-SKT Oljedempere
W1703010150	BRK-P 0150-SKT Oljedempere
W1703010200	BRK-P 0200-SKT Oljedempere
W1703010250	BRK-P 0250-SKT Oljedempere
W1703010300	BRK-P 0300-SKT Oljedempere
W1703010350	BRK-P 0350-SKT Oljedempere
W1703010400	BRK-P 0400-SKT Oljedempere

JUSTERBAR MINUSBEVEGELSE + SKIP OG STOP VENTIL

W1703110050	BRK-N 0050-SKT Oljedempere
W1703110100	BRK-N 0100-SKT Oljedempere
W1703110150	BRK-N 0150-SKT Oljedempere
W1703110200	BRK-N 0200-SKT Oljedempere
W1703110250	BRK-N 0250-SKT Oljedempere
W1703110300	BRK-N 0300-SKT Oljedempere
W1703110350	BRK-N 0350-SKT Oljedempere
W1703110400	BRK-N 0400-SKT Oljedempere



TILBEHØR OLJE- DEMPER

Artikkelnr.	Benevnelse
-------------	------------

FLENSFESTE CF

W0950402012	CF-040 Flensfeste BRK
W0950502012	CF-050 Flensfeste BRK
W0950632012	CF-063 Flensfeste BRK
W0950802012	CF-080 Flensfeste BRK

FESTESETT FOR FLENSFESTE CF

W0950402111	BRK-P/C-040 Festesett for CF
W0950502111	BRK-P/C-050 Festesett for CF
W0950632111	BRK-P/C-063 Festesett for CF
W0950802111	BRK-P/C-080 Festesett for CF

FESTESETT FOR FOTFESTE

W0950402110	BRK-P/A-040 Festesett for A
W0950502110	BRK-P/A-050 Festesett for A
W0950632110	BRK-P/A-063 Festesett for A
W0950802110	BRK-P/A-080 Festesett for A

MINISYLINDER KOMPAKT

MINISYLINDER KOMPAKT Enkelvirkende Ø6 ÷ Ø16

W1000060005	CRTC-006-0005-S000-00
W1000060010	CRTC-006-0010-S000-00
W1000060015	CRTC-006-0015-S000-00
W1000100005	CRTC-010-0005-S000-00
W1000100010	CRTC-010-0010-S000-00
W1000100015	CRTC-010-0015-S000-00
W1000160005	CRTC-016-0005-S000-00
W1000160010	CRTC-016-0010-S000-00
W1000160015	CRTC-016-0015-S000-00

DREIESYLINDER

Artikkelnr.	Benevnelse
-------------	------------

DREIESYLINDER Ø32 ÷ Ø100

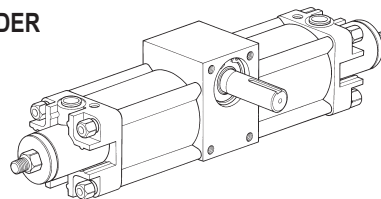

MERK!

W165...1...	Aksel utvendig, uten justering
W165...2...	Aksel utvendig, uten justering
W166...1...	Aksel utvendig, uten justering
W166...2...	Aksel utvendig, uten justering

DREIESYLINDER Ø32 UTEN JUSTERING

W1650321090	RTGC 032-090 S.R Dreiesylinder
W1650321180	RTGC 032-180 S.R Dreiesylinder
W1650321360	RTGC 032-360 S.R Dreiesylinder

DREIESYLINDER Ø32 MED JUSTERING

W1650322090	RTGC 032-090 C.R Dreiesylinder
W1650322180	RTGC 032-180 C.R Dreiesylinder
W1650322360	RTGC 032-360 C.R Dreiesylinder

DREIESYLINDER Ø40 UTEN JUSTERING

W1650401090	RTGC 040-090 S.R Dreiesylinder
W1650401180	RTGC 040-180 S.R Dreiesylinder
W1650401360	RTGC 040-360 S.R Dreiesylinder

DREIESYLINDER Ø40 MED JUSTERING

W1650402090	RTGC 040-090 C.R Dreiesylinder
W1650402180	RTGC 040-180 C.R Dreiesylinder
W1650402360	RTGC 040-360 C.R Dreiesylinder

DREIESYLINDER Ø50 UTEN JUSTERING

W1650501090	RTGC 050-090 S.R Dreiesylinder
W1650501180	RTGC 050-180 S.R Dreiesylinder
W1650501360	RTGC 050-360 S.R Dreiesylinder

DREIESYLINDER Ø50 MED JUSTERING

W1650502090	RTGC 050-090 C.R Dreiesylinder
W1650502180	RTGC 050-180 C.R Dreiesylinder
W1650502360	RTGC 050-360 C.R Dreiesylinder

Artikkelnr.	Benevnelse
-------------	------------

DREIESYLINDER Ø63 UTEN JUSTERING

W1650631090	RTGC 063-090 S.R Dreiesylinder
W1650631180	RTGC 050-180 S.R Dreiesylinder
W1650631360	RTGC 050-360 S.R Dreiesylinder

DREIESYLINDER Ø63 MED JUSTERING

W1650632090	RTGC 063-090 C.R Dreiesylinder
W1650632180	RTGC 063-180 C.R Dreiesylinder
W1650632360	RTGC 063-360 C.R Dreiesylinder

DREIESYLINDER Ø80 UTEN JUSTERING

W1650801090	RTGC 080-090 S.R Dreiesylinder
W1650801180	RTGC 080-180 S.R Dreiesylinder
W1650801360	RTGC 080-360 S.R Dreiesylinder

DREIESYLINDER Ø80 MED JUSTERING

W1650802090	RTGC 080-090 C.R Dreiesylinder
W1650802180	RTGC 080-180 C.R Dreiesylinder
W1650802360	RTGC 080-360 C.R Dreiesylinder

DREIESYLINDER Ø100 UTEN JUSTERING

W1651001090	RTGC 100-090 S.R Dreiesylinder
W1651001180	RTGC 100-180 S.R Dreiesylinder
W1651001360	RTGC 100-360 S.R Dreiesylinder

DREIESYLINDER Ø100 MED JUSTERING

W1651002090	RTGC 100-090 C.R Dreiesylinder
W1651002180	RTGC 100-180 C.R Dreiesylinder
W1651002360	RTGC 100-360 C.R Dreiesylinder

TILBEHR DREIESYLINDER

Artikkelnr.	Benevnelse
-------------	------------

MAGNETFØLER

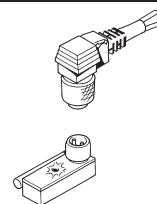

W0950000201	DSM2-C525 NO Reedkontakt
W0950000222	PNP DSM3-N225 Hallkontakt
W0950000232	NPN DSM3-M225 Hallkontakt

FESTEBØYLE FOR MAGNETFØLER



W0950000711	DST80 D.32/40 Festeboyle
W0950000712	DST81 D.50/63 Festeboyle
W0950000713	DST82 D.80/100/125 Festeboyle

Artikkelnr. Benevnelse

VENTILER SERIE 70 SOV ELSTYRTE

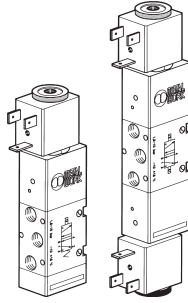

7010020100	SOV 23 SOB 00 Ventil
7010020200	SOV 23 SOS NC Ventil
7010020300	SOV 23 SEB 00 Ventil
7010020400	SOV 23 SOS NO Ventil
7010020500	SOV 23 SES NC Ventil
7010021100	SOV 25 SOS 00 Ventil
7010021200	SOV 25 SOB 00 Ventil
7010021300	SOV 25 SOD 00 Ventil
7010021500	SOV 25 SES 00 Ventil
7010021600	SOV 25 SEB 00 Ventil
7010022100	SOV 26 SOS CC Ventil
7010022200	SOV 26 SOS OC Ventil
7010022300	SOV 26 SOS PC Ventil
7010022400	SOV 26 SES CC Ventil
7010022500	SOV 26 SES OC Ventil
7010022600	SOV 26 SES PC Ventil
7020020100	SOV 33 SOB 00 Ventil
7020020200	SOV 33 SOS NC Ventil
7020020300	SOV 33 SEB 00 Ventil
7020020400	SOV 33 SOS NO Ventil
7020020500	SOV 33 SES NC Ventil
7020021100	SOV 35 SOS 00 Ventil
7020021200	SOV 35 SOB 00 Ventil
7020021300	SOV 35 SOD 00 Ventil
7020021500	SOV 35 SES 00 Ventil
7020021600	SOV 35 SEB 00 Ventil
7020022100	SOV 36 SOS CC Ventil
7020022200	SOV 36 SOS OC Ventil
7020022300	SOV 36 SOS PC Ventil
7020022400	SOV 36 SES CC Ventil
7020022500	SOV 36 SES PC Ventil
7020022600	SOV 36 SES PC Ventil
7030020100	SOV 43 SOB 00 Ventil
7030020200	SOV 43 SOS NC Ventil
7030020300	SOV 43 SEB 00 Ventil
7030020400	SOV 43 SOS NO Ventil
7030020500	SOV 43 SES NC Ventil
7030021100	SOV 45 SOS 00 Ventil
7030021200	SOV 45 SOB 00 Ventil
7030021300	SOV 45 SOD 00 Ventil
7030021500	SOV 45 SES 00 Ventil
7030021600	SOV 45 SEB 00 Ventil
7030021700	SOV 45 SED 00 Ventil
7030022100	SOV 46 SOS CC Ventil
7030022200	SOV 46 SOS OC Ventil
7030022300	SOV 46 SOS PC Ventil
7030022400	SOV 46 SES CC Ventil
7030022500	SOV 46 SES OC Ventil
7030022600	SOV 46 SES PC Ventil

Artikkelnr. Benevnelse

VENTILER SERIE 70 PNV PNEUMATISK STYRTE

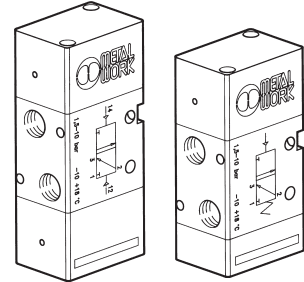

7010010100	PNV 23 PNB NC Ventil
7010010200	PNV 23 PNS NC Ventil
7010011100	PNV 25 PNS 00 Ventil
7010011200	PNV 25 PNB 00 Ventil
7010011300	PNV 25 PND 00 Ventil
7010012100	PNV 26 PNS CC Ventil
7010012200	PNV 26 PNS OC Ventil
7010012300	PNV 26 PNS PC Ventil
7020010100	PNV 33 PNB NC Ventil
7020010200	PNV 33 PNS NC Ventil
7020010210	PNV 33 PNM NC Ventil
7020011100	PNV 35 PNS 00 Ventil
7020011200	PNV 35 PNB 00 Ventil
7020011300	PNV 35 PND 00 Ventil
7020012100	PNV 36 PNS CC Ventil
7020012200	PNV 36 PNS OC Ventil
7020012300	PNV 36 PNS PC Ventil
7030010100	PNV 43 PNB 00 Ventil
7030010200	PNV 43 PNS NC Ventil
7030011100	PNV 45 PNS 00 Ventil
7030011200	PNV 45 PNB 00 Ventil
7030011300	PNV 45 PND 00 Ventil
7030012100	PNV 46 PNS CC Ventil
7030012200	PNV 46 PNS OC Ventil
7030012300	PNV 46 PNS PC Ventil

Artikkelnr. Benevnelse

**VENTILER SERIE 70
MAV MANUELLT
STYRTE**

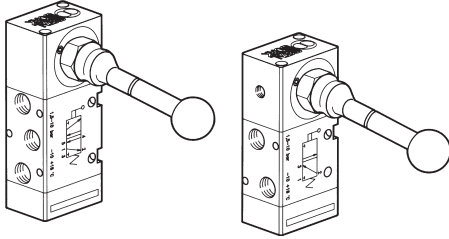

7010000100	MAV 23 LES NC Ventil
7010000200	MAV 23 LEB 00 Ventil
7010000300	MAV 25 LES 00 Ventil
7010000400	MAV 25 LEB 00 Ventil
7010000500	MAV 26 LEO CC Ventil
7010000600	MAV 26 LEO OC Ventil
7010000700	MAV 26 LEO PC Ventil
7010000900	MAV 26 LES OC Ventil
7010001000	MAV 26 LES CC Ventil
7010001100	MAV 26 LES PC Ventil
7010001200	MAV 23 PPS NC Ventil
7010001300	MAV 23 PPB 00 Ventil
7010001400	MAV 23 VLB 00 Ventil
7010001500	MAV 25 PPS 00 Ventil
7010001600	MAV 25 PPB 00 Ventil
7010001700	MAV 25 VLB 00 Ventil
7010001800	MAV 23 BRE NC Ventil
7010001900	MAV 25 BRE 00 Ventil
7020000100	MAV 33 LES NC Ventil
7020000200	MAV 33 LEB 00 Ventil
7020000300	MAV 35 LES 00 Ventil
7020000400	MAV 35 LEB 00 Ventil
7020000500	MAV 36 LEO CC Ventil
7020000600	MAV 36 LEO OC Ventil
7020000700	MAV 36 LEO PC Ventil
7020000900	MAV 36 LES OC Ventil
7020001000	MAV 36 LES CC Ventil
7020001100	MAV 36 LES PC Ventil
7020001400	MAV 33 VLB 00 Ventil
7020001700	MAV 35 VLB 00 Ventil
7030000100	MAV 43 LES NC Ventil
7030000200	MAV 43 LEB 00 Ventil
7030000300	MAV 45 LES 00 Ventil
7030000400	MAV 45 LEB 00 Ventil
7030000500	MAV 46 LEO CC Ventil
7030000600	MAV 46 LEB OC Ventil
7030000700	MAV 46 LEB PC Ventil
7030000900	MAV 46 LES OC Ventil
7030001000	MAV 46 LES CC Ventil
7030001100	MAV 46 LES PC Ventil

Artikkelnr. Benevnelse

VENTILER SERIE 70 MEV MEKANISK STYRTE

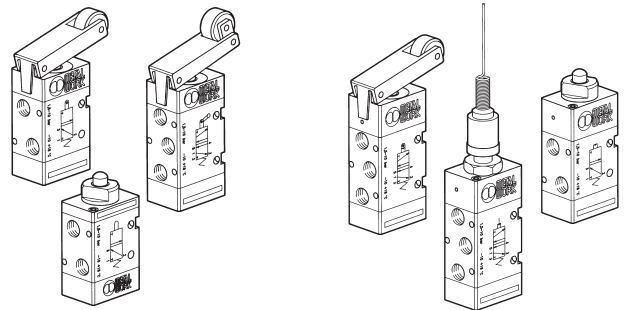

7001000100	MEV 23 TAS NC Ventil
7001000110	MEV 25 TAS 00 Ventil
7001000500	MEV 23 BRS NC Ventil
7001000510	MEV 25 BRS 00 Ventil
7001000600	MEV 23 URS NC Ventil
7001000610	MEV 25 URS 00 Ventil

VENTILER SERIE 70 MEV MEKANISK STYRTE - SERVO

7001000200	MEV 23 TSS NC Ventil
7001000210	MEV 25 TSS 00 Ventil
7001000400	MEV 23 RSS NC Ventil
7001000410	MEV 25 RSS 00 Ventil
7001000700	MEV 23 ASS NC Ventil
7001000710	MEV 25 ASS 00 Ventil

Artikkelnr.	Benevnelse
-------------	------------

TILKOBLINGSLISTER

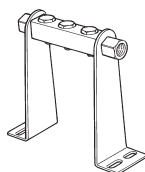

0221000190	CSA-18-00 Sett høg 1/8
0221000191	CSA-18-0C Sett lav 1/8
0221000192	Sett ekstra lav + koppl. 1/8
0221000200	CSA-18-02 Tilkobl.list
0221000300	CSA-18-03 Tilkobl.list
0221000400	CSA-18-04 Tilkobl.list
0221000500	CSA-18-05 Tilkobl.list
0221000600	CSA-18-06 Tilkobl.list
0221000700	CSA-18-07 Tilkobl.list
0222000190	CSA-14-00 Sett høg 1/4
0222000191	CSA-14-0C Sett lav 1/4
0222000192	Sett ekstra lav + koppl. 1/4
0222000200	CSA-14-02 Tilkobl.list
0222000300	CSA-14-03 Tilkobl.list
0222000400	CSA-14-04 Tilkobl.list
0222000500	CSA-14-05 Tilkobl.list
0222000600	CSA-14-06 Tilkobl.list
0222000700	CSA-14-07 Tilkobl.list

MANIFOLD MODULÆR/BASE

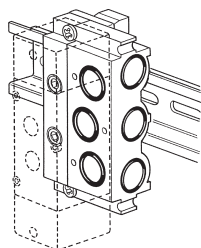

0226004000	Mellommembran 1/8"
0226004001	Plugg for 3/2 1/8"
0226004150	Komplett basplatte 1/8
0226004200	Endeplate inngang 1/8"
0226004201	Endeplate utgang 1/8"
0226004300	Mellomplate 1/8"
0226004500	Blindplate 1/8
0226004600	Adapter omegaskinne 1/8
0226004700	Kompl. monteringssett 1/8
0226005000	Mellommembran 1/4"
0226005001	Plugg for 3/2 1/4"
0226005150	Komplett basplatte 1/4
0226005200	Endeplate inngang 1/4
0226005201	Endeplate utgang 1/4
0226005300	Mellomplate 1/4
0226005500	Blindplate 1/4"
0226005600	Adapter omegaskinne 1/4
0226005700	Kompl. monteringssett 1/4
0226006600	Overgangspl. 1/8-1/4

Artikkelnr.	Benevnelse
-------------	------------

MANIFOLD BASE

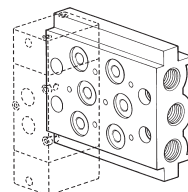

0223000201	CVM-18-02 Basplate
0223000301	CVM-18-03 Basplate
0223000401	CVM-18-04 Basplate
0223000501	CVM-18-05 Basplate
0223000601	CVM-18-06 Basplate
0223000701	CVM-18-07 Basplate
0223000801	CVM-18-08 Basplate
0223000901	CVM-18-09 Basplate
0223001001	CVM-18-10 Basplate
0224000201	CVM-14-02 Basplate
0224000301	CVM-14-03 Basplate
0224000401	CVM-14-04 Basplate
0224000501	CVM-14-05 Basplate
0224000601	CVM-14-06 Basplate
0224000701	CVM-14-07 Basplate
0224000801	CVM-14-08 Basplate
0224000901	CVM-14-09 Basplate
0224001001	CVM-14-10 Basplate

OBS! Priser for elstyrte ventiler inkluderer ikke spole

SPOLE STANDARD 2W

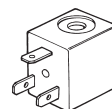

W0215000101	Spole 22 Ø8 BA 2W-24VDC
W0215000111	Spole 22 Ø8 BA 3.6VA-24VAC
W0215000121	Spole 22 Ø8 BA 3.6VA-110VAC
W0215000131	Spole 22 Ø8 BA 3.6VA-220VAC

SPOLE 5W

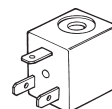

W0215000001	Spole 22 Ø8 3.8W-24VDC
W0215000011	Spole 22 Ø8 6.5VA-24VAC
W0215000021	Spole 22 Ø8 6.5VA-110VAC
W0215000031	Spole 22 Ø8 6.5VA-220VAC
W0215000051	Spole 22 Ø8 5W-12VDC

KONTAKT

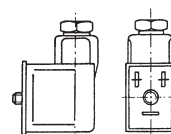

W0970510011	22 STD Kontakt
W0970510012	22 LED 24V Kontakt
W0970510013	22 LED 110V Kontakt
W0970510014	22 LED 220V Kontakt
W0970510015	22 LED VDR 24V Kontakt
W0970510016	22 LED VDR 110V Kontakt
W0970510017	22 LED VDR 220V Kontakt

VENTILER SERIE 70 BASE

Artikkelnr. Benevnelse

PNEUMATISK STYRTE

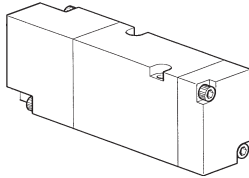

7011011200	PNV B5 PNB 00 Ventil
7011011300	PNV B5 PND 00 Ventil
7011011100	PNV B5 PNS 00 Ventil
7011012100	PNV B6 PNS CC Ventil
7011012200	PNV B6 PNS OC Ventil
7011012300	PNV B6 PNS PC Ventil

ELSTYRTE

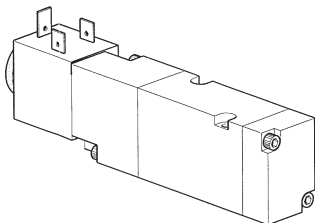

7011021100	SOV B5 SOS 00 Ventil
7011021200	SOV B5 SOB 00 Ventil
7011021300	SOV B5 SOD 00 Ventil
7011021500	SOV B5 SES 00 Ventil
7011021600	SOV B5 SEB 00 Ventil
7011022100	SOV B6 SOS CC Ventil
7011022200	SOV B6 SOS OC Ventil
7011022300	SOV B6 SOS PC Ventil
7011022400	SOV B6 SES CC Ventil
7011022500	SOV B6 SES OC Ventil
7011022600	SOV B6 SES PC Ventil

OBS! Priser for elstyrte ventiler inkluderer ikke spole

TILBEHØR VENTILER SERIE 70 BASE

Artikkelnr. Benevnelse

MANIFOLD BASE

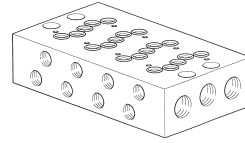

0223100201	Sett for 2 pos. 1/8 på basplate
0223100401	Sett for 4 pos. 1/8 på basplate
0223100601	Sett for 6 pos. 1/8 på basplate
0223100801	Sett for 8 pos. 1/8 på basplate
0223101001	Sett for 10 pos. 1/8 på basplate

MELLOMPLATER

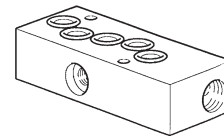

0223106301	Mellomplate for sep. pålufting
0223106302	Mellomplate for sep. avlufting
0223106303	Mellomplate for avluftstruping
0223106500	Blindplate for basanslutning

SPOLE STANDARD 2W

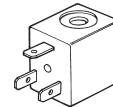

W0215000101	Spole 22 Ø8 BA 2W-24VDC
W0215000111	Spole 22 Ø8 BA 3.6VA-24VAC
W0215000121	Spole 22 Ø8 BA 3.6VA-110VAC
W0215000131	Spole 22 Ø8 BA 3.6VA-220VAC

SPOLE 5W

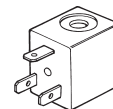

W0215000001	Spole 22 Ø8 3.8W-24VDC
W0215000011	Spole 22 Ø8 6.5VA-24VAC
W0215000021	Spole 22 Ø8 6.5VA-110VAC
W0215000031	Spole 22 Ø8 6.5VA-220VAC
W0215000051	Spole 22 Ø8 5W-12VDC

KONTAKT

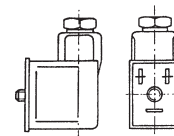

W0970510011	22 STD Kontakt
W0970510012	22 LED 24V Kontakt
W0970510013	22 LED 110V Kontakt
W0970510014	22 LED 220V Kontakt
W0970510015	22 LED VDR 24V Kontakt
W0970510016	22 LED VDR 110V Kontakt
W0970510017	22 LED VDR 220V Kontakt



MINI- VENTILER SERIE VME

VENTILER ISO 1 - 2

Artikkelnr. Benevnelse

MINIVENTILER VME

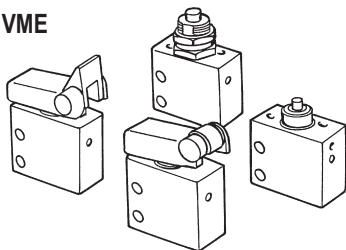

W3501000100	VME1-01 3/2 NC Ventil
W3501000101	VME1-10 3/2 NO Ventil
W3501000200	VME1-02 3/2 NC Ventil
W3501000300	VME1-03 3/2 NC Ventil
W3501000400	VME1-04 3/2 NC Ventil

HÅNDBETJENT VENTIL FOR VME1-01 OG VME1-10

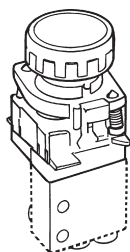

0351000050	VME1-000 Adapterplate
W0351000011	VRM-010 RN Trykk knapp monost.
W0351000013	VRM-050 R Trykk knapp monost.
W0351000014	VRM-065 R Trykk knapp nødstop
W0351000015	VRM-054 R Manøverpinne
W0351000016	VRM-201 N Nøkkelvriknapp, låsbart
W0351000030	VRM-350 N Vriknapp monostabilt
W0351000031	VRM-300 N Vriknapp bistabilt
W0351000032	VRM-383 N Vriknapp 3-pos. monost.
W0351000033	VRM-313 N Vriknapp 3-pos. bist.
W0351000034	VRM-450 N Lang vriknapp monost.
W0351000035	VRM-400 N Lang vriknapp bist.
W0351000036	VRM-483 N Lang vriknapp 3-pos. monost.
W0351000037	VRM-413 N Lang vriknapp 3-pos. bist.
W0351000050	Adapter for hull Ø30
W0351000054	Plate grønn, for VRM-010

FOTVENTILER

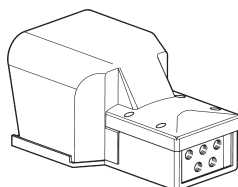

W3120000001	PEV 35 PES PR Fotventil
W3120000011	PEV 35 PEB PR Fotventil
W3120000301	PEV F3 PES PR Fotventil
W3120000311	PEV F3 PEC PR Fotventil
W3120000321	PEV 03 PES PR Fotventil
W3120000331	PEV 03 PEC PR Fotventil
W3120000401	PEV F3 PES WP Fotventil
W3120000411	PEV 03 PES WP Fotventil

Artikkelnr. Benevnelse

VENTILER ISO 1 PNEUMATISK STYRT

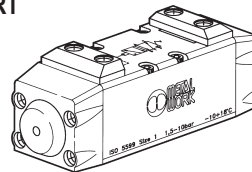

7051011100	IPV 55 PNS 00 Ventil
7051011200	IPV 55 PNB 00 Ventil
7051011300	IPV 55 PND 00 Ventil
7051012100	IPV 56 PNS CC Ventil
7051012200	IPV 56 PNS OC Ventil
7051012300	IPV 56 PNS PC Ventil

VENTILER ISO 1 ELSTYRT CNOMO

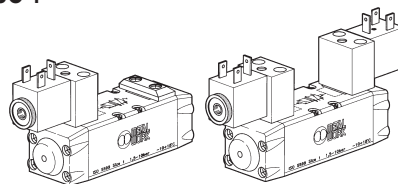

7051021100	ISV 55 SOS 00 Ventil
7051021200	ISV 55 SOB 00 Ventil
7051021300	ISV 55 SOD 00 Ventil
7051021400	ISV 55 SES 00 Ventil
7051021500	ISV 55 SEB 00 Ventil
7051021600	ISV 55 SED 00 Ventil
7051022100	ISV 56 SOS CC Ventil
7051022200	ISV 56 SOS OC Ventil
7051022300	ISV 56 SOS PC Ventil
7051022400	ISV 56 SES CC Ventil
7051022500	ISV 56 SES OC Ventil
7051022600	ISV 56 SES PC Ventil

VENTILER ISO 1 ELSTYRT, IN-LINE PILOT

7053021100	ISV 55 DOS 00 Ventil
7053021400	ISV 55 DES 00 Ventil
7053021200	ISV 55 DOB 00 Ventil
7053021500	ISV 55 DEB 00 Ventil
7053022100	ISV 56 DOS CC Ventil
7053022200	ISV 56 DOS OC Ventil
7053022300	ISV 56 DOS PC Ventil
7053022400	ISV 56 DES CC Ventil
7053022500	ISV 56 DES OC Ventil
7053022600	ISV 56 DES PC Ventil

OBS! Priser for elstyrte ventiler inkluderer ikke spole

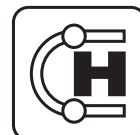

TILBEHØR

Artikkelnr. Benevnelse

VENTILER ISO 2 PNEUMATISK STYRT

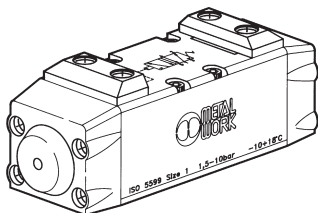

7052011100	IPV 65 PNS 00 Ventil
7052011200	IPV 65 PNB 00 Ventil
7052011300	IPV 65 PND 00 Ventil
7052012100	IPV 66 PNS CC Ventil
7052012200	IPV 66 PNS OC Ventil
7052012300	IPV 66 PNS PC Ventil

VENTILER ISO 2 ELSTYRT CNOMO

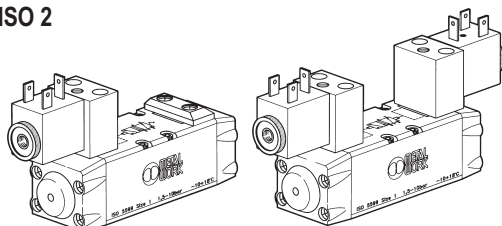

7052021100	ISV 65 SOS 00 Ventil
7052021200	ISV 65 SOB 00 Ventil
7052021300	ISV 65 SOD 00 Ventil
7052021400	ISV 65 SES 00 Ventil
7052021500	ISV 65 SEB 00 Ventil
7052021600	ISV 65 SED 00 Ventil
7052022100	ISV 66 SOS CC Ventil
7052022200	ISV 66 SOS OC Ventil
7052022300	ISV 66 SOS PC Ventil
7052022400	ISV 66 SES CC Ventil
7052022500	ISV 66 SES OC Ventil
7052022600	ISV 66 SES PC Ventil

OBS! Priser for elstyrte ventiler inkluderer ikke spole

Artikkelnr. Benevnelse

BASPLATER ISO 1

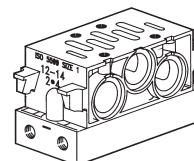

0228000100	BSS-1 Basplate side
0228000110	BSB-1 Basplate ned
0228000150	BMS-1 Basplate batt.
0228000155	BMB-1 Basplate batt.
0228000200	TIN-1 Basplate gavle
0228000201	TIS-1 Basplate gavle
0228000210	TCI-1 Basplate
0228000300	TIA-1 Basplate mitt.
0228000301	TIB-1 Mellomst. ned
0228000400	DIA-1 Mellom membran
0228000500	PCS-1 Blindplate
0228000700	KIT ISO 1 Monterings sett

BASPLATER ISO 2

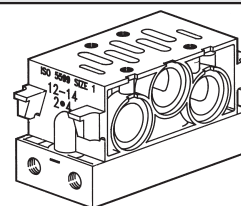

0228001100	BSS-2 Basplate side
0228001110	BSB-2 Basplate ned
0228001150	BMS-2 Basplate batt.
0228001155	BMB-2 Batterim. ned
0228001200	TIN-2 Basplate gavel
0228001201	TIS-2 Basplate gavel
0228001210	TCI-2 Blindplate
0228001300	TIA-2 Mellomst. opp
0228001301	TIB-2 Mellomst. ned
0228001400	DIA-2 Mellom membran
0228001500	PCS-2 Blindplate
0228001700	KIT ISO 2 Monterings sett

ADAPTERPLATE

0228000600	ADT1-2 Adapterplate
------------	---------------------

KONTAKT FOR ISO VENTILER

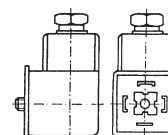

W0970520033	30 STD Kontakt
W0970520034	30 LED 24V Kontakt
W0970520035	30 LED 110V Kontakt
W0970520036	30 LED 220V Kontakt
W0970520037	30 LED VDR 24V Kontakt
W0970520038	30 LED VDR 110V Kontakt
W0970520039	30 LED VDR 220V Kontakt



DIREKTESTYRTE MAGNETVENTILER SERIE PIV

Artikkelnr.	Benevnelse
-------------	------------

KONTAKT

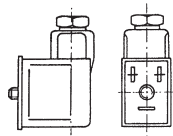

W0970510011	22 STD Kontakt
W0970510012	22 LED 24V Kontakt
W0970510013	22 LED 110V Kontakt
W0970510014	22 LED 220V Kontakt
W0970510015	22 LED VDR 24V Kontakt
W0970510016	22 LED VDR 110V Kontakt
W0970510017	22 LED VDR 220V Kontakt

SPOLE 5W FOR ISO VENTILER

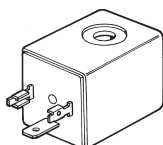

W0210010100	Spole 30 Ø8 5W-24VDC
W0210011100	Spole 30 Ø8 5VA-24VAC
W0210012100	Spole 30 Ø8 5VA-110VAC
W0210013100	Spole 30 Ø8 5VA-220VAC

SPOLE STANDARD 2W

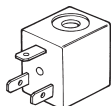

W0215000101	Spole 22 Ø8 BA 2W-24VDC
W0215000111	Spole 22 Ø8 BA 3.6VA-24VAC
W0215000121	Spole 22 Ø8 BA 3.6VA-110VAC
W0215000131	Spole 22 Ø8 BA 3.6VA-220VAC

SPOLE 5W

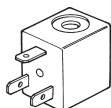

W0215000001	Spole 22 Ø8 3.8W-24VDC
W0215000011	Spole 22 Ø8 6.5VA-24VAC
W0215000021	Spole 22 Ø8 6.5VA-110VAC
W0215000031	Spole 22 Ø8 6.5VA-220VAC
W0215000051	Spole 22 Ø8 5W-12VDC

Artikkelnr.	Benevnelse
-------------	------------

VENTIL 10 mm PIV.P

W4005001000	Pilot 10mm 24VDC LED PLUG-IN
-------------	------------------------------

VENTILER PIV.M

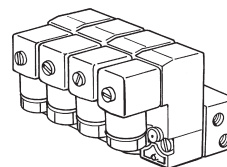

W4015001000	PIV33M01 NC Ventil
W4015001001	PIV33M02 NC Ventil
W4015001010	PIV33M03 NC Ventil
W4015001011	PIV33M04 NC Ventil
W4015001020	PIV33M05 NC Ventil
W4015001021	PIV33M06 NC Ventil
W4015001030	PIV33M07 NC Ventil
W4015001031	PIV33M08 NC Ventil
W4015001100	PIV63M01 NC Ventil
W4015001101	PIV63M02 NC Ventil
W4015001110	PIV63M03 NC Ventil
W4015001111	PIV63M04 NC Ventil
W4015001120	PIV63M05 NC Ventil
W4015001121	PIV63M06 NC Ventil
W4015001130	PIV63M07 NC Ventil
W4015001131	PIV63M08 NC Ventil
W4015002000	PIV13M01 NO Ventil
W4015002010	PIV13M02 NO Ventil
W4015002020	PIV13M05 NO Ventil
W4015002030	PIV13M07 NO Ventil

VENTILER PIV.I

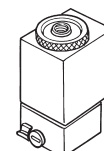

W4017000100	PIV42I5S NC Ventil
W4017000101	PIV72I5S NC Ventil
W4017001100	PIV42I8S NC Ventil
W4017001200	PIV72I8S NC Ventil
W4017001201	PIV72I8S NO Ventil
W4017001300	PIV92I8S NC Ventil
W4017003100	PIV43I5S NC Ventil
W4017004100	PIV43I8S NC Ventil
W4017004200	PIV73I8S NC Ventil
W4017004201	PIV73I8S NO Ventil
W4018000100	PIV22I0S NC Ventil
W4018000200	PIV42I0S NC Ventil
W4018000300	PIV72I0S NC Ventil
W4018001100	PIV23I0S NC Ventil
W4018001200	PIV43I0S NC Ventil
W4018001300	PIV73I0S NC Ventil
W4018002100	PIV43I0S NC Ventil

OBS! Priser for elstyrte ventiler inkluderer ikke spole

TILBEHØR VENTILER PIV

Artikkelnr.	Benevnelse
-------------	------------

VENTILER PIV.T

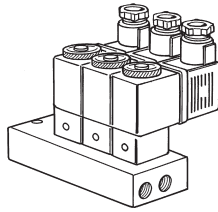

W402500200	PIV73TOO NC Ventil
W402500201	PIV73T00 NO Ventil
W4025002100	PIV73TOB NC Ventil
W4025002101	PIV73TOO NO Ventil
W4025002200	PIV53TOB NC Ventil
W4025002300	PIV83TOB NC Ventil
W4025002301	PIV83TOB NC Ventil
W4025002400	PIV53T00 NC Ventil
W4025002500	PIV83T00 NC Ventil
W4025002501	PIV83T00 NO Ventil

VENTILER PIV.B

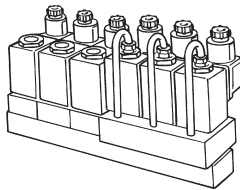

W4026003000	PIV43BOS NC Ventil
W4026003050	PIVY3BCS NC Ventil
W4026003100	PIVY3B0S NO Ventil
W4026004000	PIV92B4S NC Ventil
W4026004001	PIV92B4S NO Ventil
W4026004010	PIVVX2B4S NC Ventil
W4026004020	PIVZ2B4S NC Ventil
W4026005000	PIV73B8S NC Ventil
W4026005001	PIV73B8S NO Ventil
W4026005010	PIV93B8S NC Ventil
W4026005020	PIVW3B8S NC Ventil
W4026005100	PIV73B4S NC Ventil
W4026005101	PIV73B4S NO Ventil
W4026005110	PIV93B4S NC Ventil
W4026005111	PIV93B4S NO Ventil
W4026005120	PIVW3B4S NC Ventil

PILOTDEL CNOMO

9453920	Pilotdel 3/2 CNOMO Monost.
9453922	Pilotdel 3/2 CNOMO Bist.

Artikkelnr.	Benevnelse
-------------	------------

BASPLATER FOR PIV.B

W0400101201	B4001 Basplate
W0400101202	B4002 Basplate
W0400101203	B4003 Basplate
W0400101204	B4004 Basplate
W0400101205	B4005 Basplate
W0400101206	B4006 Basplate
W0400101207	B4007 Basplate
W0400101208	B4008 Basplate
W0400101209	B4009 Basplate

BASPLATER FOR PIV.I

W0400111101	EB60/1 Basplate
W0400111102	EB60/2 Basplate
W0400111103	EB60/3 Basplate
W0400111104	EB60/4 Basplate
W0400111105	EB60/5 Basplate
W0400111106	EB60/6 Basplate
W0400111107	EB60/7 Basplate
W0400111108	EB60/8 Basplate
W0400111109	EB60/9 Basplate
W0400111110	EB60/10 Basplate

MODULER

W0400111201	EB 8000 T1 Basplate
W0400111202	EB 8000 T2 Basplate
W0400111200	EB 8000 I Basplate
W0400112000	Blindplatta EB-6000

BASPLATER FOR PIV.P

W0400100101	P1150/1 Basplate
W0400100102	P1150/2 Basplate
W0400100103	P1150/3 Basplate
W0400100104	P1150/4 Basplate
W0400100105	P1150/5 Basplate
W0400100106	P1150/6 Basplate
W0400100107	P1150/7 Basplate
W0400100108	P1150/8 Basplate
W0400100109	P1150/9 Basplate
W0400100110	P1150/10 Basplate

BASPLATER FOR PIV.M

W0400101001	B 5001 Basplate
W0400101002	B 5002 Basplate
W0400101003	B 5003 Basplate
W0400101004	B 5004 Basplate
W0400101005	B 5005 Basplate
W0400101006	B 5006 Basplate
W0400101007	B 5007 Basplate
W0400101008	B 5008 Basplate
W0400101009	B 5009 Basplate
W0400101010	B 5010 Basplate
W0400102000	Blindplate B-5000
W0400102001	Adapter NC/NO B90



Artikkelnr.	Benevnelse
-------------	------------

BASPLATER FOR PIV.T

W0400101101	I90/1 Basplate
W0400101102	I90/2 Basplate
W0400101103	I90/3 Basplate
W0400101104	I90/4 Basplate
W0400101105	I90/5 Basplate
W0400101106	I90/6 Basplate
W0400101107	I90/7 Basplate
W0400101108	I90/8 Basplate
W0400101109	I90/9 Basplate
W0400101110	I90/10 Basplate
W0400101190	Adapter NC/NO I-9000
W0400112000	BlindplateEB-6000

MODULPLATER CNOMO

0227000150	CNOMO Sett modulplate
0227000200	CNOMO modulplate inngang+skruer

SPOLE FOR PIV.I

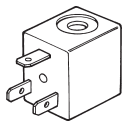

W0215000001	Spole 22 Ø8 3.8W-24VDC
W0215000011	Spole 22 Ø8 6.5VA-24VAC
W0215000021	Spole 22 Ø8 6.5VA-110VAC
W0215000031	Spole 22 Ø8 6.5VA-220VAC
W0215000101	Spole 22 Ø8 BA 2W-24VDC
W0215000111	Spole 22 Ø8 BA 3.6VA-24VAC
W0215000121	Spole 22 Ø8 BA 3.6VA-110VAC
W0215000131	Spole 22 Ø8 BA 3.6VA-220VAC

SPOLE FOR PIV.B

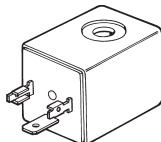

W0216001001	Spole 30 Ø13 10W-24VDC
W0216001011	Spole 30 Ø13 16VA-24VAC
W0216001021	Spole 30 Ø13 16VA-110VAC
W0216001031	Spole 30 Ø13 16VA-220VAC

SPOLE FOR PIV.T

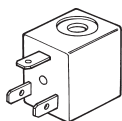

W0216000101	Spole 22 Ø9 BA 2W-24VDC
W0216000111	Spole 22 Ø9 BA 3VA-24VAC
W0216000121	Spole 22 Ø9 BA 3VA-110VAC
W0216000131	Spole 22 Ø9 BA 3VA-220VAC

Artikkelnr.	Benevnelse
-------------	------------

KONTAKT FOR VENTILER PIV.M

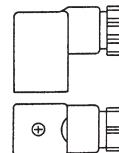

W0970500011	15 STD Kontakt
W0970500012	15 LED 24V Kontakt
W0970500013	15 LED 110V Kontakt
W0970500015	15 LED VDR 24V Kontakt
W0970500016	15 LED VDR 110V Kontakt

KONTAKT FOR VENTILER PIV.B

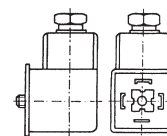

W0970520033	30 STD Kontakt
W0970520034	30 LED 24V Kontakt
W0970520035	30 LED 110V Kontakt
W0970520036	30 LED 220V Kontakt
W0970520037	30 LED VDR 24V Kontakt
W0970520038	30 LED VDR 110V Kontakt
W0970520039	30 LED VDR 220V Kontakt

KONTAKT FOR VENTILER PIV.T

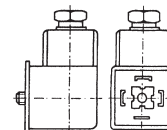

W0970510011	22 STD Kontakt
W0970510012	22 LED 24V Kontakt
W0970510013	22 LED 110V Kontakt
W0970510014	22 LED 220V Kontakt
W0970510015	22 LED VDR 24V Kontakt
W0970510016	22 LED VDR 110V Kontakt
W0970510017	22 LED VDR 220V Kontakt

VENTILER MACH 11

Artikkelnr.	Benevnelse
-------------	------------

VENTILER MACH 11 PNEUMATISK STYRTE

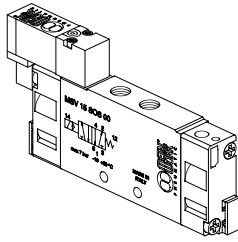

7061010110	MPV 15 PNB 00 Ventil
7061010130	MPV 15 PNS 00 Ventil
7061010210	MPV 16 PNS CC Ventil
7061010310	MPV 16 PNS OC Ventil
7061010410	MPV 16 PNS PC Ventil

VENTILER MACH 11 ELSTYRTE

7061020112	MSV 15 SOB 00 24VDC Ventil
7061020132	MSV 15 SOS 00 24VDC Ventil
7061020212	MSV 16 SOS CC 24VDC Ventil
7061020312	MSV 16 SOS OC 24VDC Ventil
7061020412	MSV 16 SOS PC 24VDC Ventil
7061030112	MSV 15 SEB 00 24VDC Ventil
7061030132	MSV 15 SES 00 24VDC Ventil
7061030212	MSV 16 SES CC 24VDC Ventil
7061030312	MSV 16 SES OC 24VDC Ventil
7061030412	MSV 16 SES PC 24VDC Ventil

TILBEHØR MACH 11

PLUG-IN KONTAKT

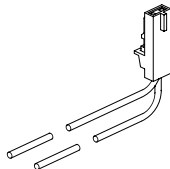

W0970512000	MACH 11 PLUG-IN Kontakt 300mm
-------------	-------------------------------

LYDDEMPER

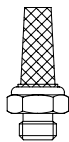

W0970530020	MWSE M7 Lyddemper
-------------	-------------------

RESERVEDELER MACH 11

PLUG-IN PILOT

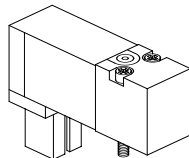

W4005001000	Pilot 10mm 24VDC LED PLUG-IN
-------------	------------------------------

VENTILER MACH 16

Artikkelnr.	Benevnelse
-------------	------------

VENTILER MACH 16 PNEUMATISK STYRTE

7062010110	MPV 25 PNB 00 Ventil
7062010100	MPV 25 PNP 00 Ventil
7062010310	MPV 26 PNS OC Ventil
7062010210	MPV 26 PNS CC Ventil
7062010410	MPV 26 PNS PC Ventil

VENTILER MACH 16 ELSTYRTE

7062020102	MSV 25 SOP 00 24VDC Ventil
7062020103	MSV 25 SOP 00 24VAC Ventil
7062020104	MSV 25 SOP 00 110VAC Ventil
7062020105	MSV 25 SOP 00 220VAC Ventil
7062020112	MSV 25 SOB 00 24VDC Ventil
7062020113	MSV 25 SOB 00 24VAC Ventil
7062020114	MSV 25 SOB 00 110VAC Ventil
7062020115	MSV 25 SOB 00 220VAC Ventil
7062020212	MSV 26 SOS CC 24VDC Ventil
7062020213	MSV 26 SOS CC 24VAC Ventil
7062020214	MSV 26 SOS CC 110VAC Ventil
7062020215	MSV 26 SOS CC 220VAC Ventil
7062020312	MSV 26 SOS OC 24VDC Ventil
7062020313	MSV 26 SOS OC 24VAC Ventil
7062020314	MSV 26 SOS OC 110VAC Ventil
7062020315	MSV 26 SOS OC 220VAC Ventil
7062020412	MSV 26 SOS PC 24VDC Ventil
7062020413	MSV 26 SOS PC 24VAC Ventil
7062020414	MSV 26 SOS PC 110VAC Ventil
7062020415	MSV 26 SOS PC 220VAC Ventil
7062030112	MSV 25 SEB 00 24VDC Ventil
7062030113	MSV 25 SEB 00 24VAC Ventil
7062030114	MSV 25 SEB 00 110VAC Ventil
7062030115	MSV 25 SEB 00 220VAC Ventil
7062030132	MSV 25 SES 00 24VDC Ventil
7062030133	MSV 25 SES 00 24VAC Ventil
7062030134	MSV 25 SES 00 110VAC Ventil
7062030135	MSV 25 SES 00 220VAC Ventil
7062030212	MSV 26 SES CC 24VDC Ventil
7062030213	MSV 26 SES CC 24VAC Ventil
7062030214	MSV 26 SES CC 110VAC Ventil
7062030215	MSV 26 SES CC 220VAC Ventil
7062030312	MSV 26 SES OC 24VDC Ventil
7062030313	MSV 26 SES OC 24VAC Ventil
7062030314	MSV 26 SES OC 110VAC Ventil
7062030315	MSV 26 SES OC 220VAC Ventil
7062030412	MSV 26 SES PC 24VDC Ventil
7062030413	MSV 26 SES PC 24VAC Ventil
7062030414	MSV 26 SES PC 110VAC Ventil
7062030415	MSV 25 SES PC 220VAC Ventil

BASPLATER FOR PNEUMATISK STYRTE VENTILER

0225000201	CVM PN-08-02-0-000 Liste
0225000401	CVM PN-08-04-0-000 Liste
0225000601	CVM PN-08-06-0-000 Liste
0225000801	CVM PN-08-08-0-000 Liste
0225001001	CVM PN-08-10-0-000 Liste
0225001201	CVM PN-08-12-0-000 Liste

Artikkelnr. Benevnelse

**MODULBASPLATER
MACH 16**

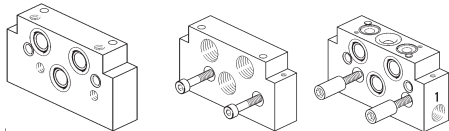

022710000	Mellommembran MACH 16 & 18
0227100150	Basplate side MACH 16
0227100200	MACH 16/18 Endestykke utg.
0227100201	MACH 16/18 Endestykke inng.
0227100301	Basplate M16, sep. inng.trykk
0227100302	Basplate M16, ing.tryck 3&5

VENTILER MACH 16 FOR MULTIPELBASPLATER 24VDC/24VAC

7062040102	MSV 25 SMP 00 24VDC Ventil
7062040112	MSV 25 SMB 00 24VDC Ventil
7062040212	MSV 26 SMS CC 24VDC Ventil
7062040312	MSV 26 SMS OC 24VDC Ventil
7062040412	MSV 26 SMS PC 24VDC Ventil
7062040103	MSV 25 SMP 00 24VAC Ventil
7062040113	MSV 25 SMB 00 24VAC Ventil
7062040213	MSV 26 SMS CC 24VAC Ventil
7062040313	MSV 26 SMS OC 24VAC Ventil
7062040413	MSV 26 SMS PC 24VAC Ventil
7062040132	MSV 25 SMS 00 24VDC Ventil
7062040133	MSV 25 SMS 00 24VAC Ventil
7062060112	MSV 25 SCB 00 24VDC Ventil
7062060113	MSV 25 SCB 00 24VAC Ventil
7062060132	MSV 25 SCS 00 24VDC Ventil
7062060133	MSV 25 SCS 00 24VAC Ventil
7062060212	MSV 26 SCS 00 24VDC Ventil
7062060213	MSV 26 SCS CC 24VAC Ventil
7062060312	MSV 26 SCS OC 24VDC Ventil
7062060313	MSV 26 SCS OC 24VAC Ventil
7062060412	MSV 26 SCS PC 24VDC Ventil
7062060413	MSV 26 SCS PC 24VAC Ventil

**VENTILER MACH 16 FOR MULTIPELBASPLATER 24VDC/24VAC
MED INNEBYGGD PNEUMATIKK FITTINGS**

7066040102	MSV G5 SMP 00 24VDC Ventil
7066040103	MSV G5 SMP 00 24VAC Ventil
7066040112	MSV G5 SMB 00 24VDC Ventil
7066040113	MSV G5 SMB 00 24VAC Ventil
7066040132	MSV G5 SMS 00 24VDC Ventil
7066040133	MSV G5 SMS 00 24VAC Ventil
7066040212	MSV G6 SMS CC 24VDC Ventil
7066040213	MSV G6 SMS CC 24VAC Ventil
7066040312	MSV G6 SMS OC 24VDC Ventil
7066040313	MSV G6 SMS OC 24VAC Ventil
7066040412	MSV G6 SMS PC 24VDC Ventil
7066040413	MSV G6 SMS PC 24VAC Ventil
7067040102	MSV H5 SMP 00 24VDC Ventil
7067040103	MSV H5 SMP 00 24VAC Ventil
7067040112	MSV H5 SMB 00 24VDC Ventil
7067040113	MSV H5 SMB 00 24VAC Ventil
7067040132	MSV H5 SMS 00 24VDC Ventil
7067040133	MSV H5 SMS 00 24VAC Ventil
7067040212	MSV H6 SMS CC 24VDC Ventil
7067040213	MSV H6 SMS CC 24VAC Ventil
7067040312	MSV H6 SMS OC 24VDC Ventil
7067040313	MSV H6 SMS OC 24VAC Ventil
7067040412	MSV H6 SMS PC 24VDC Ventil
7067040413	MSV H6 SMS PC 24VAC Ventil

Artikkelnr. Benevnelse

**BASPLATER FOR
MULTIPOLTILKOBLING
MACH 16 24VDC / 24VAC**

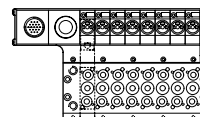
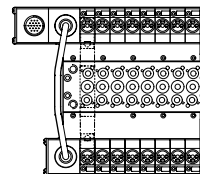

0225100401	CVM EP 08-04-M-MCN 24VDC List
0225100601	CVM EP-08-06-M-MCN 24VDC List
0225100801	CVM EP-08-08-M-MCN 24VDC List
0225101001	CVM EP-08-10-M-MCN 24VDC List
0225101201	CVM EP-08-12-M-MCN 24VDC List
0225200401	CVM EP 08-04-B-MCN 24VDC List
0225200601	CVM EP 08-06-B-MCN 24VDC List
0225200801	CVM EP 08-08-B-MCN 24VDC List
0225201001	CVM EP 08-10-B-MCN 24VDC List
0225201201	CVM EP-08-12-B-MCN 24VDC List
0225110401	CVM EP 08-04-M-MCN 24VAC List
0225110601	CVM EP 08-06-M-MCN 24VAC List
0225110801	CVM EP 08-08-M-MCN 24VAC List
0225111001	CVM EP 08-10-M-MCN 24VAC List
0225111201	CVM EP 08-12-M-MCN 24VAC List
0225210401	CVM EP 08-04-B-MCN 24VAC List
0225210601	CVM EP 08-06-B-MCN 24VAC List
0225210801	CVM EP 08-08-B-MCN 24VAC List
0225211001	CVM EP 08-10-B-MCN 24VAC List
0225211201	CVM EP 08-12-B-MCN 24VAC List

**BASPLATER FOR
MULTIPOLTILKOBLING
MACH 16 24VDC / 24VAC
MED FORMONTERT
KABEL 5M**

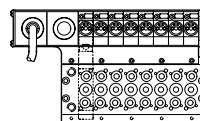
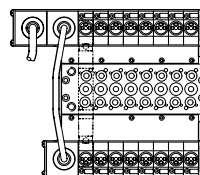

0225400401	CVM EP-08-04-M-WC5 24VDC List
0225400601	CVM EP-08-06-M-WC5 24VDC List
0225400801	CVM EP-08-08-M-WC5 24VDC List
0225401001	CVM EP-08-10-M-WC5 24VDC List
0225401201	CVM EP-08-12-M-WC5 24VDC List
0225500401	CVM EP-08-04-B-WC5 24VDC List
0225500601	CVM EP-08-06-B-WC5 24VDC List
0225500801	CVM EP-08-08-B-WC5 24VDC List
0225501001	CVM EP-08-10-B-WC5 24VDC List
0225501201	CVM EP-08-12-B-WC5 24VDC List
0225410401	CVM EP 08-04-M-WC5 24VAC List
0225410601	CVM EP 08-06-M-WC5 24VAC List
0225410801	CVM EP 08-08-M-WC5 24VAC List
0225411001	CVM EP 08-10-M-WC5 24VAC List
0225411201	CVM EP 08-12-M-WC5 24VAC List
0225510401	CVM EP 08-04-B-WC5 24VAC List
0225510601	CVM EP 08-06-B-WC5 24VAC List
0225510801	CVM EP 08-08-B-WC5 24VAC List
0225511001	CVM EP 08-10-B-WC5 24VAC List
0225511201	CVM EP 08-12-B-WC5 24VAC List

Artikkelnr. Benevnelse

**TILLEGGSPLETER
FOR MULTIPOLTILK.
MACH 16**

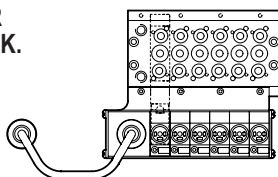

- | | |
|------------|-------------------------------|
| 0225300401 | CVM EP 08-04-M-ACM 24VDC List |
| 0225300601 | CVM EP-08-06-M-ACM 24VDC List |
| 0225300801 | CVM EP-08-08-M-ACM 24VDC List |
| 0225310401 | CVM EP 08-04-M-ACM 24VAC List |
| 0225310601 | CVM EP 08-06-M-ACM 24VAC List |
| 0225310801 | CVM EP 08-08-M-ACM 24VAC List |

**MACH VENTILER
KAN LEVERES
MONTERT PÅ
BASPLATER,
FUNKSJONS-
OG TETTTHETSTESTET
FØR LEVERING**

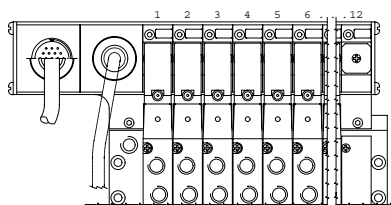

**HOVEDENHET FOR
MULTIPOLTILKOBLING
MED KONTAKT
24VDC / 24VAC**

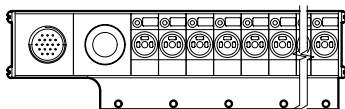

- | | |
|------------|----------------------------|
| 0226500401 | PP0 08 04 24VDC Hovedenhet |
| 0226500601 | PP0 08 06 24VDC Hovedenhet |
| 0226500801 | PP0 08 08 24VDC Hovedenhet |
| 0226501001 | PP0 08 10 24VDC Hovedenhet |
| 0226501201 | PP0 08 12 24VDC Hovedenhet |
| 0226510401 | PP0 08 04 24VAC Hovedenhet |
| 0226510601 | PP0 08 06 24VAC Hovedenhet |
| 0226510801 | PP0 08 08 24VAC Hovedenhet |
| 0226511001 | PP0 08 10 24VAC Hovedenhet |
| 0226511201 | PP0 08 12 24VAC Hovedenhet |

Artikkelnr. Benevnelse

**HOVEDENHET FOR
MULTIPOLTILKOBLING
MED FORMONTERT
KABEL 5M
24VDC / 24VAC**

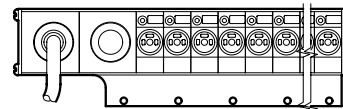

- | | |
|------------|----------------------------|
| 0226400401 | PP5 08 04 24VDC Hovedenhet |
| 0226400601 | PP5 08 06 24VDC Hovedenhet |
| 0226400801 | PP5 08 08 24VDC Hovedenhet |
| 0226401001 | PP5 08 10 24VDC Hovedenhet |
| 0226401201 | PP5 08 12 24VDC Hovedenhet |
| 0226410401 | PP5 08 04 24VAC Hovedenhet |
| 0226410601 | PP5 08 06 24VAC Hovedenhet |
| 0226410801 | PP5 08 08 24VAC Hovedenhet |
| 0226411001 | PP5 08 10 24VAC Hovedenhet |
| 0226411201 | PP5 08 12 24VAC Hovedenhet |

**SEKUNDÆRENHET
MULTIPOLTILKOBLING
24VDC / 24VAC**

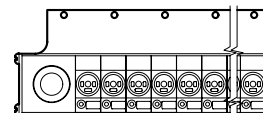

- | | |
|------------|-------------------------------|
| 0226200401 | SO0 08 04 24VDC Sekundærenhet |
| 0226200601 | SO0 08 06 24VDC Sekundærenhet |
| 0226200801 | SO0 08 08 24VDC Sekundærenhet |
| 0226210401 | SO0 08 04 24VAC Sekundærenhet |
| 0226210601 | SO0 08 06 24VAC Sekundærenhet |
| 0226210801 | SO0 08 08 24VAC Sekundærenhet |

**TILLEGGSENHET
MULTIPOLTILKOBLING
24VDC / 24VAC**

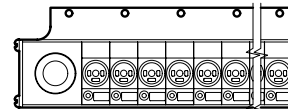

- | | |
|------------|-------------------------------|
| 0226300401 | SA0 08 04 24VDC Tilleggsenhet |
| 0226300601 | SA0 08 06 24VDC Tilleggsenhet |
| 0226300801 | SA0 08 08 24VDC Tilleggsenhet |
| 0226310401 | SA0 08 04 24VAC Tilleggsenhet |
| 0226310601 | SA0 08 06 24VAC Tilleggsenhet |
| 0226310801 | SA0 08 08 24VAC Tilleggsenhet |

Artikkelnr. Benevnelse

KABEL 10 POL

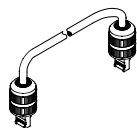

0226150022 Kabel MACH 16 10-pol 220mm
For andre lengder, kontakt vår salgsavdeling

KONTAKT

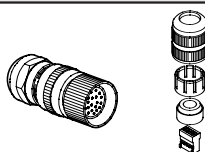

0226170002 Kontakt 10-pol, MACH 16
0226170001 Kontakt 19-pol, MACH 16

KABEL (uten kontakt)

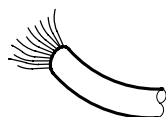

0226107201 Kabel 10-pol u. kontakt, M16
0226107101 Kabel 19-pol u. kontakt, M16

19-POL KABEL MED KONTAKT

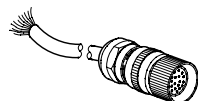

0226140200 Kabel m. kontakt 19-pol L=2m
0226140500 Kabel m. kontakt 19-pol L=5m
0226141000 Kabel m. kontakt 19-pol L=10m
0226141500 Kabel m. kontakt 19-pol L=15m
0226142000 Kabel m. kontakt 19-pol L=20m
0226143000 Kabel m. kontakt 19-pol L=30m

Øvrige utførelser på forespørsel

MERKEPLATE FOR IDENTIFIKASJON

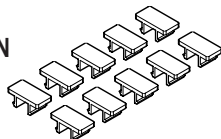

0226107000 Merkeplate hvit, sett 10stk.

PAKNINGSETT ELKONTAKTER

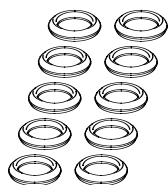

0226107001 Pakningsett elkontakter 10st

Artikkelnr. Benevnelse

PAKNINGSETT BASPLATE

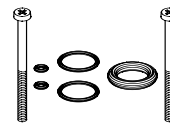

0226007001 MACH 16 Pakningsett 1 pos

BLINDPLATE ELTIKOBLING

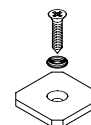

0225004502 PCS-EL-MACH Blindplate el

PILOT

W4015201000 Pilot M16 24VDC, for multipelbasplate
W4015201010 Pilot M16 24VAC, for multipelbasplate

KONTAKT

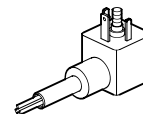

W0970504021 Kontakt CVM, 15 DIN 43650 STD 2m

BLINDPLATE FOR LUFT

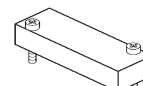

0225004500 PCS-MACH 16 Blindplate luft

KABELDON FOR MACH 16

W0970501021 FORMA C 15mm STD Kontakt
W0970501022 FORMA C 15mm LED 24V Kontakt
W0970501025 FORMA C 15mm LED VDR 24V Kabel.

PILOT FOR MACH 16 IN-LINE

W4015101000 Pilot MACH 16/18 24VDC
W4015101010 Pilot MACH 16/18 24VAC
W4015101020 Pilot MACH 16/18 110VAC
W4015101030 Pilot MACH 16/18 220VAC

ADAPTER FOR OMEGASKINNE

0225004600 ADT-MACH Adapter

VENTILER MACH 18



Artikkelnr.	Benevnelse
-------------	------------

VENTILER MACH 18 PNEUMATISKT STYRTE

7063010110	MPV D5 PNB 00 Ventil
7063010130	MPV D5 PNS 00 Ventil
7063010210	MPV D6 PNS CC Ventil
7063010310	MPV D6 PNS CC Ventil
7063010410	MPV D6 PNS PC Ventil

VENTILER MACH 18 ELSTYRTE

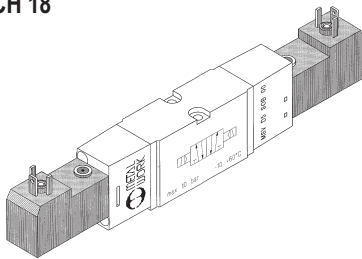

7063020112	MSV D5 SOB 00 24VDC Ventil
7063020113	MSV D5 SOB 00 24VAC Ventil
7063020114	MSV D5 SOB 00 110VAC Ventil
7063020115	MSV D5 SOB 00 220VAC Ventil
7063020132	MSV D5 SOS 00 24VDC Ventil
7063020133	MSV D5 SOS 00 24VAC Ventil
7063020134	MSV D5 SOS 00 110VAC Ventil
7063020135	MSV D5 SOS 00 220VAC Ventil
7063020212	MSV D6 SOS CC 24VDC Ventil
7063020213	MSV D6 SOS CC 24VAC Ventil
7063020214	MSV D6 SOS CC 110VAC Ventil
7063020215	MSV D6 SOS CC 220VAC Ventil
7063020312	MSV D6 SOS OC 24VDC Ventil
7063020313	MSV D6 SOS OC 24VAC Ventil
7063020314	MSV D6 SOS OC 110VAC Ventil
7063020315	MSV D6 SOS OC 220VAC Ventil
7063020412	MSV D5 SOS PC 24VDC Ventil
7063020413	MSV D5 SOS PC 24VAC Ventil
7063020414	MSV D5 SOS PC 110VAC Ventil
7063020415	MSV D6 SOS PC 220VAC Ventil
7063030112	MSV D5 SEB 00 24VDC Ventil
7063030113	MSV D5 SEB 00 24VAC Ventil
7063030114	MSV D5 SEB 00 110VAC Ventil
7063030115	MSV D5 SEB 00 220VAC Ventil
7063030132	MSV D5 SES 00 24VDC Ventil
7063030133	MSV D5 SES 00 24VAC Ventil
7063030134	MSV D5 SES 00 110VAC Ventil
7063030135	MSV D5 SES 00 220VAC Ventil
7063030212	MSV D6 SES CC 24VDC Ventil
7063030213	MSV D6 SES CC 24VAC Ventil
7063030214	MSV D6 SES CC 110VAC Ventil
7063030215	MSV D6 SES CC 220VAC Ventil
7063030312	MSV D6 SES OC 24VDC Ventil
7063030313	MSV D6 SES OC 24VAC Ventil
7063030314	MSV D6 SES OC 110VAC Ventil
7063030315	MSV D6 SES OC 220VAC Ventil
7063030412	MSV D6 SES PC 24VAC Ventil
7063030413	MSV D6 SES PC 24VAC Ventil
7063030414	MSV D6 SES PC 110VAC Ventil

Artikkelnr.	Benevnelse
-------------	------------

PILOT FOR MACH 18

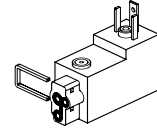

W4015101000	Pilot MACH 16/18 24VDC
W4015101010	Pilot MACH 16/18 24VAC
W4015101020	Pilot MACH 16/18 110VAC
W4015101030	Pilot MACH 16/18 220VAC

MODULBASPLATER FOR MACH 18 VDMA

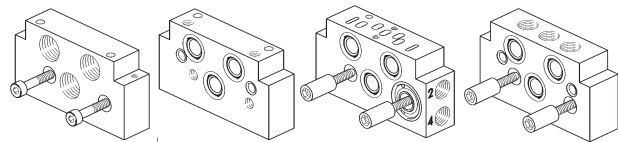

0227100201	MACH 16/18 Endestykke inng.
0227100200	MACH 16/18 Endestykke utg.
0227200150	VDMA Modul tilkobling side
0227200300	VDMA Modul mellomplate
0227100000	Mellom membran MACH 16 & 18

KONTAKT FOR MACH 18

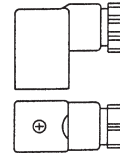

W0970501021	FORMA C 15mm STD Kontakt
W0970501022	FORMA C 15mm LED 24V Kontakt
W0970501025	FORMA C 15mm LED VDR 24V Kabeld.

BLINDPLATE FOR UBRUKT POSISJON

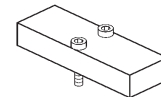

0227200500	PCS MACH 18 Blindplate luft
------------	-----------------------------

Artikkelnr. Benevnelse

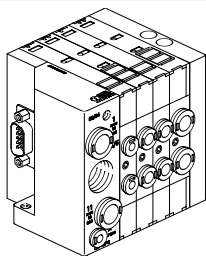

- 7068030532 NSV F8 SES NC Ventil
- 7068030632 NSV F8 SES NO Ventil
- 7068030732 NSV F8 SES OO Ventil
- 7069030532 NSV G8 SES NC Ventil
- 7069030632 NSV G8 SES NO Ventil
- 7069030732 NSV G8 SES OO Ventil
- 7070030532 NSV H8 SES NC Ventil
- 7070030632 NSV H8 SES NO Ventil
- 7070030732 NSV H8 SES OO Ventil
- 7068030132 NSV F5 SES 00 Ventil
- 7069030132 NSV G5 SES 00 Ventil
- 7070030132 NSV H5 SES 00 Ventil
- 7068030112 NSV F5 SEB 00 Ventil
- 7069030112 NSV G5 SEB 00 Ventil
- 7070030112 NSV H5 SEB 00 Ventil
- 7068030212 NSV F6 SES CC Ventil
- 7069030212 NSV G6 SES CC Ventil
- 7070030212 NSV H6 SES CC Ventil

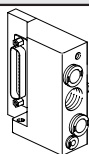

0227300200 Endeplate 1-11

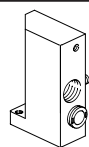

0227300201 Endeplate 1

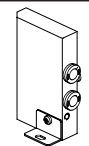

0227300300 Redusert endeplate 1

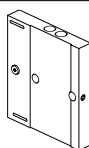

0227300500 Blind endeplate

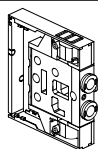

0227300301 Mellomplate

Artikkelnr. Benevnelse

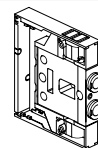

0227300302 Mellomplate blind

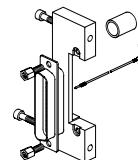

0226180001 Sett for axiell 25-poli kontakt

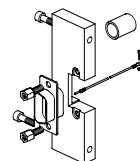

0226180002 Sett for axiell 9-pol kontakt

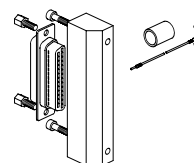

0226180003 Sett bakre 25-pol kontakt

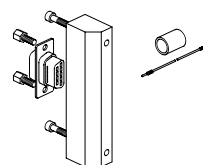

0226180004 Sett for bakre 9-pol kontakt

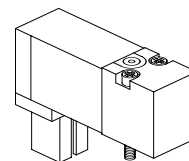

W4005001000 Pilot 10mm 24VDC LED PLUG-IN

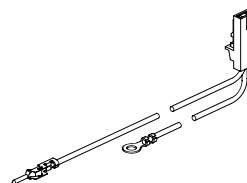

0226180400 Kabelsett 1-12 pos.

0226180401 Kabelsett 13-30 pos.

Artikkelnr. Benevnelse

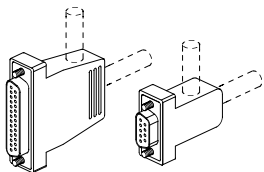

0226180102 Kontakt 9-pol
0226180101 Kontakt 25-pol

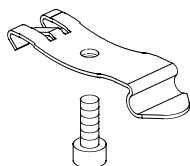

0227300600 Feste for DIN-skinne (NSV)

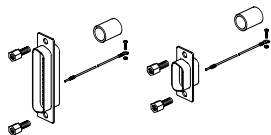

0226180201 Sett for kontakt 25-pol
0226180202 Sett for kontakt 9-pol

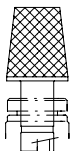

W0970530084 MWSC Ø8 Lyddemper

FIELD BUS

SLAVE IP 20
INTERBUS / PROFIBUS

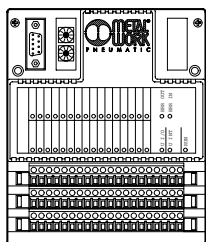

0240001012 Slave 16I IP20 INTERBUS
0240001016 Slave 32I IP20 INTERBUS
0240001011 Slave 16O IP20 INTERBUS
0240001015 Slave 16 O/I IP20 INTERBUS
0240001002 Slave 16I IP20 PROFIBUS
0240001006 Slave 32I IP20 PROFIBUS
0240001001 Slave 16O IP20 PROFIBUS
0240001005 Slave 16O/I IP20 PROFIBUS

Slave IP20 kan også leveres komplett monteret med ventilpakke Mach16, Mach 18 og serie 70*

Artikkelnr. Benevnelse

SLAVE IP 65
INTERBUS / PROFIBUS

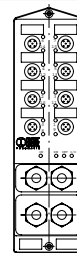

0240002011 Slave 8O IP65 INTERBUS
0240002012 Slave 16I IP65 INTERBUS
0240002014 Slave 4O+8I IP65 INTERBUS
0240002001 Slave 8O IP65 PROFIBUS
0240002002 Slave 16I IP65 PROFIBUS
0240002004 Slave 4O+8I IP65 PROFIBUS

Slave IP65 kan også leveres komplett monteret med ventilpakke, ISO 1, ISO 2 og serie 70*

SLAVE IP 65
INTERBUS / PROFIBUS
FOR MACH 16

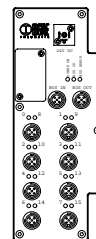

0240003007 Slavesett 16O for modulplate PROFIBUS
0240003008 Slavesett 16O/I for modulplate PROFIBUS
0240003001 Slavesett 16O M16 multip. PROFIBUS
0240003005 Slavesett 16I/O M16 multip. PROFIBUS
0240003011 Slavesett 16O M16 multip. INTERBUS
0240003015 Slavesett 16I/O M16 multip. INTERBUS
0240003017 Slavesett 16O for modulplate INTERBUS
0240003018 Slavesett 16O/I for modulplate INTERBUS

Slave IP65 kan også leveres komplett monteret med ventilpakke Mach16,

TILBEHØR

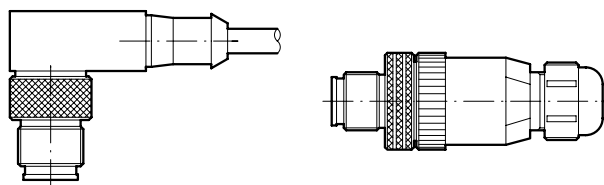

0240009001 BUS-kontakt, vinkel uten kabel
0240009002 BUS-kontakt, rett 1,5m kabel
0240009003 BUS-kontakt, rett 5m kabel
0240009021 BUS-kontakt, rett uten kabel
0240009022 BUS-kontakt, vinkel 1,5m kabel
0240009023 BUS-kontakt, vinkel 5m kabel
0240009031 BUS-kontakt, Y-koppl. 0,6m
0240009032 BUS-kontakt, Y-kpl. 1,5m kabel
0240009040 Plugg M12 for BUS



KODENØKKELENTILER

VENTILER SERIE 70

S O V	2	3	S O	S	N C
VENTILFAMILIE	DIMENSJON	FUNKSJON	AKTIVERING	RETUR	ANDRE SPESIFIKASJONER
SOV elstyrte	B 1/8"	3 3/2	Elstyrte ventiler	A intern luftretur	00 5/2
MAV manuelt styrte	på basplate	5 5/2	SO elstyrt	S fjærretur	NC normalt stengt
PNV luftstyrte	2 1/8"	6 5/3	SE elstyrt med ekstern lufttilførsel	B bistabil	NO normalt åpen
MEV mekanisk styrte	3 1/4"		SP spesialutførelse	D differensial	CC stengt midtnivå
	4 1/2"		Luftstyrte ventiler	O tre pos. stabil	OC avluftet midtnivå
			PN lufstyrt	P luftretur	PC trykksatt midtnivå
			Manuelt styrte ventiler		
			PP dra/trykk		
			VL vippespak		
			LE håndtak 90°		
			BRE Manøvrering Breter		
			Mekanisk styrte ventiler		
			TA pinne		
			BR hjul		
			UR vippehjul		
			TS pinne servostyrt		
			RS hjul servostyrt		
			AS servostyrt		

VENTILER ISO

I S V	5	5	S O	B	O C
VENTILFAMILIE	DIMENSJON	FUNKSJON	AKTIVERING	RETUR	ANDRE SPESIFIKASJONER
ISV ISO elstyrte	5 ISO 1	5 5/2	SO elstyrt	A intern luftretur	NO åpen
IPV ISO luftstyrte	6 ISO 2	6 5/3	SE elstyrt med ekstern lufttilførsel	S fjærretur	CC stengt midtnivå
			SP spesialutførelse	B bistabil	OCavluftet midtnivå
			PN lufstyrt	D differensial	PC trykksatt midtnivå
			Pilotdel i linje	O tre pos. stabil	
			DE elstyrt med ekstern lufttilførsel	P luftretur	
			DO elstyrt		

MACH 11

M S V	1	5	S O	B	0 0	24 VDC
FAMILIE	ANSL.	FUNKSJON	AKTIVERING 14	RETUR 12	ANDRE SPESIFIKASJONER	SPENNING
MSV mini elstyrte ventiler	1 M7	5 5/2	SO Elstyrt	P Luftretur	00 5/2 standard	24Vdc
MPV mini luftstyrte ventiler		6 5/3	SE Ekstern lufttilførsel	B Bistabil	CC 5/3 stengt midtnivå	
				S Mekanisk fjærretur	OC 5/3 åpen midtnivå	
					PC 5/3 trykksatt midtnivå	

MACH 16-18

M S V	2	5	S O	B	O C	24 VDC
VENTILFAMILJ	DIMENSJON	FUNKSJON	AKTIVERING	RETUR	ANDRE SPESIFIKASJONER	SPENNING
MSV elstyrte	2 1/8"	5 5/2	SO elstyrt	S fjærretur	00 5/2	24Vdc
MPV luftstyrte	D 1/8" stør. 02 VDMA	6 5/3	SE elstyrt med ekstern lufttilførsel	B bistabil	CC stengt midtnivå	24Vac
			PN lufstyrt	P intern luftretur	OC avluftet midtnivå	110Vac
			For multipoltilkobling		PC trykksatt midtnivå	220Vac
			SM elstyrt			
			SC elstyrt med ekstern lufttilførsel			

KODENØKKELE VENTILER



BASPLATER FOR MULTIPOLTIKKOBLENG MACH 16

BASPLATER CVM EP	0 8	0 4	M	W	C 5	2 4 V D C
	STØRRELSE	ANTALL POSISJONER				SPENNING
	08 G 1/8"	04 4 pos. 06 6 pos. 08 8 pos. 010 2 pos. 012 12 pos.	M elstyrt utførelse for monostabile ventiler B elstyrt utførelse for bistabile ventiler		MCN elektrisk kontakt formontert kabel 5 meter WC5 ACM tilleggskontakt for monostabilt batteri	24V= 24V 50/60HZ

VENTILER MACH 16 KOMPLETT MONTERTE OG TESTET PÅ BASPLATER

A	0 4	M	W	C 5	0 8	2 4 V D C	
VENTILFAMILIE	ANTALL POSISJONER				STØRRELSE	SPENNING	
A basplate for MACH 16	04 4 pos. 06 6 pos. 08 8 pos. 010 2 pos. 012 12 pos.	M elstyrt utførelse for monostabile ventiler B elstyrt utførelse for bistabile ventiler		MCN elektrisk kontakt formontert kabel 5 meter WC5 ACM tilleggskontakt for monostabil batteri	08 G 1/8"	Sekvens for plasing av ventiler på basplate L MSV 25 SMP M MSV 25 SMS J MSV 25 SMB G MSV 26 SMS CC E MSV 26 SMS OC B MSV 26 SMS PC A BLINDPLATE LUFT	24V= 24V 50/60HZ

N.B.: Ventilplasingen monteres i en sekvens fra venstre til høye. Første ventilen i ruta er alltså den som ligger nærmest kontakten. Om man vil ha en plate med færre en 12 posisjoner, sett en null i resterende ruter for å avslutte koden.

MULTIMACH

N	S	V	F	5	S	E	B	0 0	24 VDC
FAMILIE			TILKOBLENG	FUNKSJON	AKTIVERING 14		RETUR	ANDRE SPESIFIKASJONER	SPENNING
NSV	mini magnetventil		F 11 mm patron Ø 4 G 11 mm patron Ø 6 H 14 mm patron Ø 8	5 5/2 6 5/3 8 3/2x2	SE	elstyrt	B bistabil S mekanisk fjærretur	00 5/2 OO 3/2 NC + 3/2 NO CC 5/3 centri chiusi NC norm. chiuse NO norm. aperte	24Vdc

MULTIMACH KOMPLETT ENHET

M	5	1	2	8	16-W8-W6-O4-L8-5	1 6 - 1 5
VENTIL	INPUT ENDEPLATE	ELSTYRING			UTFØRELSE	ANDRE SPESIFIKASJONER
Multimach IP51 Ventil	2 endeplate 1-11 3 endeplate 1 4 Redusert endeplate 1	8 aksiell 25-pol 9 aksiell 9-pol 10 bakre 25-pol 11 bakre 9-pol			I 2 st. 3/2 NC 5 Blind endeplate W 2 st. 3/2 NO 6 mellomstykke L 3/2 NO+3/2 NC 7 blindplate V 5/2 monostabil 4 patron 4 K 5/2 bistabil 6 patron 6 O 5/3 monostabil CC 8 patron 8	12 9-pol kontakt 13 9-pol kontakt 90° 14 25-pol kontakt 15 25-pol kontakt 90° 16 Feste for DIN-skinne



SVIVEL- KOBLINGER

Artikkelnr.	Benevnelse
-------------	------------

Artikkelnr.	Benevnelse
-------------	------------

SVIVELKOBLING MED FLERE UTGANGER

W0513131101	RTJ-MR6-38-18 Svivel
W0512131121	RTJ-MT3-38-24 Svivel

SVIVELKOBLING 2- OG 3-VEIS UTGANGER

W0514101101	RTJ-22W-18-18 Svivel
W0514121121	RTJ-22W-24-24 Svivel
W0515121121	RTJ-33W-24-24 Svivel

SVIVELKOBLING ENKEL

W0511101101	RTJ-OSG-18-18 Svivel
W0511121121	RTJ-OSG-24-24 Svivel
W0511131131	RTJ-OSG-38-38 Svivel
W0511141141	RTJ-OSG-42-42 Svivel
W0511151151	RTJ-OSG-54-54 Svivel
W0511161161	RTJ-OSG-61-61 Svivel

FORDELINGSBLOKK 4 UTGANGER

W0501101001	FRM-FO-218-0218 Fordel.blokk
W0501111002	FRM-FO-214-0214 Fordel.blokk
W0501121003	FRM-FO-238-0238 Fordel.blokk
W0501131004	FRM-FO-242-0242 Fordel.blokk

FORDELINGSBLOKK MED UTGANGER PÅ EN SIDE

W0502111001	FRM-LO-224-0218 Fordel.blokk
W0502111005	FRM-LO-224-0318 Fordel.blokk
W0502111007	FRM-LO-224-0418 Fordel.blokk
W0502111009	FRM-LO-224-0518 Fordel.blokk
W0502111011	FRM-LO-224-0618 Fordel.blokk
W0502121002	FRM-LO-238-0224 Fordel.blokk
W0502121006	FRM-LO-238-0324 Fordel.blokk
W0502121008	FRM-LO-238-0424 Fordel.blokk
W0502121010	FRM-LO-238-0524 Fordel.blokk
W0502121012	FRM-LO-238-0624 Fordel.blokk
W0502131002	FRM-LO-242-0224 Fordel.blokk
W0502131006	FRM-LO-242-0324 Fordel.blokk
W0502131008	FRM-LO-242-0424 Fordel.blokk
W0502131010	FRM-LO-242-0524 Fordel.blokk
W0502131012	FRM-LO-242-0624 Fordel.blokk

FORDELINGSBLOKK MED UTGANGER PÅ BEGGE SIDER

W0503111013	FRM-00-224-1218 Fordel.blokk
W0503111015	FRM-00-224-1318 Fordel.blokk
W0503111017	FRM-00-224-1418 Fordel.blokk
W0503111019	FRM-00-224-1518 Fordel.blokk
W0503121014	FRM-00-238-1224 Fordel.blokk
W0503121016	FRM-00-238-1324 Fordel.blokk
W0503121018	FRM-00-238-1424 Fordel.blokk
W0503121020	FRM-00-238-1524 Fordel.blokk
W0503131014	FRM-00-042-1224 Fordel.blokk
W0503131016	FRM-00-242-1324 Fordel.blokk
W0503131018	FRM-00-242-1424 Fordel.blokk
W0503131020	FRM-00-242-1524 Fordel.blokk

LYDDEMPERE



Artikkelnr.	Benevnelse	Förp.
-------------	------------	-------

LYDDEMPER MW SC

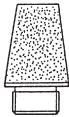

W0970530001	MWSC M5 Lyddemper	50
W0970530002	MWSC 1/8 Lyddemper	50
W0970530003	MWSC 1/4 Lyddemper	50
W0970530004	MWSC 3/8 Lyddemper	20
W0970530005	MWSC 1/2 Lyddemper	20
W0970530006	MWSC 3/4 Lyddemper	10
W0970530007	MWSC 1" Lyddemper	10

LYDDEMPER MW SCQ

W0970530012	MWSCQ 1/8 Lyddemper	50
W0970530013	MWSCQ 1/4 Lyddemper	50
W0970530014	MWSCQ 3/8 Lyddemper	20
W0970530015	MWSCQ 1/2 Lyddemper	20
W0970530016	MWSCQ 3/4 Lyddemper	10
W0970530017	MWSCQ 1" Lyddemper	10

LYDDEMPER MW SE

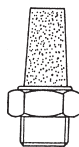

W0970530020	MWSE M7 Lyddemper	50
W0970530021	MWSE M5 Lyddemper	50
W0970530022	MWSE 1/8 Lyddemper	50
W0970530023	MWSE 1/4 Lyddemper	20
W0970530024	MWSE 3/8 Lyddemper	20
W0970530025	MWSE 1/2 Lyddemper	10
W0970530026	MWSE 3/4 Lyddemper	10
W0970530027	MWSE 1" Lyddemper	10

LYDDEMPER HØY KAPASITET MW SL

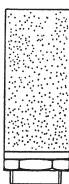

W0970530036	MWSL 3/4 Lyddemper	10
W0970530037	MWSL 1" Lyddemper	10
W0970530038	MWSL 1" 1/4 Lyddemper	5
W0970530039	MWSL 1" 1/2 Lyddemper	5
W0970530040	MWSL 2" Lyddemper	5

LYDDEMPER MW STT

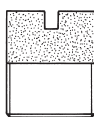

W0970530042	MWSTT 1/8 Lyddemper	50
W0970530043	MWSTT 1/4 Lyddemper	50
W0970530044	MWSTT 3/8 Lyddemper	20
W0970530045	MWSTT 1/2 Lyddemper	20
W0970530046	MWSTT 3/4 Lyddemper	10
W0970530047	MWSTT 1" Lyddemper	10

Artikkelnr.	Benevnelse	Förp.
-------------	------------	-------

LYDDEMPER MW SFE



W0970530051	MWSFE M5 Lyddemper	50
W0970530052	MWSFE 1/8 Lyddemper	50
W0970530053	MWSFE 1/4 Lyddemper	50
W0970530054	MWSFE 3/8 Lyddemper	20
W0970530055	MWSFE 1/2 Lyddemper	20
W0970530056	MWSFE 3/4 Lyddemper	10
W0970530057	MWSFE 1" Lyddemper	10

LYDDEMPER MW SPL

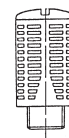

W0970530066	MWSPL 3/4 Lyddemper	10
W0970530067	MWSPL 1" Lyddemper	10

LYDDEMPER MW SPL-F

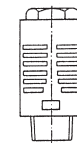

W0970530072	MWSPL-F 1/8 Lyddemper	50
W0970530073	MWSPL-F 1/4 Lyddemper	50
W0970530074	MWSPL-F 3/8 Lyddemper	20
W0970530075	MWSPL-F 1/2 Lyddemper	20

STRUPELYDDEMPER MW SVE

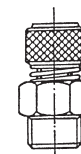

W0970520001	MWSVE 1/8 Strupelyddemper	50
W0970520002	MWSVE 1/4 Strupelyddemper	50
W0970520003	MWSVE 3/8 Strupelyddemper	20
W0970520004	MWSVE 1/2 Strupelyddemper	20
W0970520005	MWSVE 3/4 Strupelyddemper	10
W0970520006	MWSVE 1" Strupelyddemper	10

STRUPELYDDEMPER MW SVL

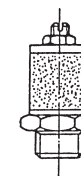

W0970520010	MWSVL M5 Strupelyddemper	50
W0970520011	MWSVL 1/8 Strupelyddemper	50
W0970520012	MWSVL 1/4 Strupelyddemper	50
W0970520013	MWSVL 3/8 Strupelyddemper	20
W0970520014	MWSVL 1/2 Strupelyddemper	20
W0970520015	MWSVL 3/4 Strupelyddemper	10
W0970520016	MWSVL 1" Strupelyddemper	10



Artikkelnr.	Benevnelse	Förop.
-------------	------------	--------

AVLUFTSSTRUPING MW DSN

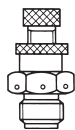

W0970520021	MWDSN 1/8 1/8 Avluftsstruping	50
W0970520022	MWDSN 1/4 1/4 Avluftsstruping	50
W0970520023	MWDSN 3/8 1/4 Avluftsstruping	20
W0970520024	MWDSN 1/2 1/4 Avluftsstruping	10

AVLUFTSSTRUPING MW DSE

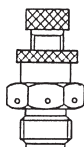

W0970520031	MWDSE 1/8 Avluftsstruping	50
W0970520032	MWDSE 1/4 Avluftsstruping	50

TILBEHØR- VENTILER

BLOKKERINGSVENTILER ENKELRETTET SERIE STP 1/8" ÷ 1/2"

W6001001001	STP-U 1/8 108 Ventil	10
W6001001106	STP-U 1/8 006 Ventil	10
W6001011011	STP-U 1/4 114 Ventil	10
W6001011106	STP-U 1/4 006 Ventil	10
W6001011108	STP-U 1/4 008 Ventil	10
W6001021021	STP-U 3/8 138 Ventil	10
W6001021108	STP-U 3/8 008 Ventil	10
W6001021110	STP-U 3/8 010 Ventil	10
W6001031112	STP-U 1/2 012 Ventil	10

Artikkelnr.	Benevnelse	Förop.
-------------	------------	--------

BLOKKERINGSVENTIL DOBBELRETTET SERIE STP 1/8" ÷ 1/2"

W6001101001	STP-B 1/8 108 Ventil	10
W6001101106	STP-B 1/8 006 Ventil	10
W6001111011	STP-B 1/4 104 Ventil	10
W6001111106	STP-B 1/4 006 Ventil	10
W6001111108	STP-B 1/4 008 Ventil	10
W6001121021	STP-B 3/8 138 Ventil	10
W6001121108	STP-B 3/8 008 Ventil	10
W6001121110	STP-B 3/8 010 Ventil	10
W6001131112	STP-B 1/2 012 Ventil	10

LOGIK- ELEMENT

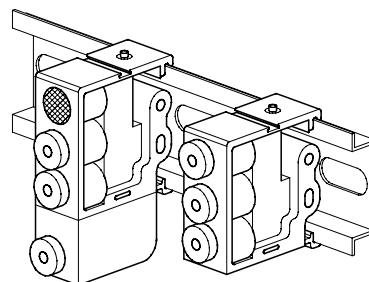

W3604000001	ELLER logikelement	
W3604000002	OG logikelement	
W3604000003	IKKE logikelement	
W3604000004	JA logikelement	
W3604000005	MINNE logikelement	

TILBAKESLAGSVENTILER

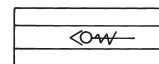

W3601000002	VNR/2-1/4 Tilbakeslavsventil	10
W3601000001	VNR/1-1/8 Tilbakeslavsventil	10

GLIDE- VENTILER

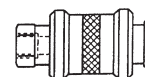

W0970050001	VCS-1/8 Glideventil	10
W0970050002	VCS-1/4 Glideventil	10
W0970050003	VCS-3/8 Glideventil	10
W0970050004	VCS-1/2 Glideventil	10

VEKSEL- VENTILER

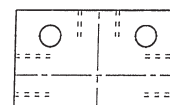

W3603000002	VOR/2-1/4 Vekselventil	5
W3603000001	VOR/1-1/8 Vekselventil	10



PNEUMATIKK UTSTYR

Artikkelnr. Benevnelse

GRIPERE PARALLELL SERIE P1



PARALLELLGRIPERE Ø16

W1540160000 PRL.GR-016-000 Griper
W1550160000 PRL.GR-016-000-M Griper

PARALLELLGRIPERE Ø20

W1540200000 PRL.GR-020-000 Griper
W1550200000 PRL.GR-020-000-M Griper

PARALLELLGRIPERE Ø32

W1540320000 PRL.GR-032-000 Griper
W1550320000 PRL.GR-032-000-M Griper

GRIPERE 2-FINGER PARALLELL SERIE P2

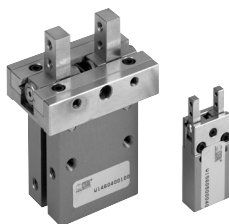

W1570060200 Griper 2-finger P2-6, parallell
W1570100200 Griper 2-finger P2-10, parallell
W1570160200 Griper 2-finger P2-16, parallell
W1570200200 Griper 2-finger P2-20, parallell
W1570250200 Griper 2-finger P2-25, parallell

GRIPERE 2-FINGER PARALLELL SERIE P3

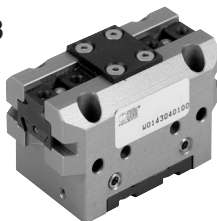

W1560500200 Prec.griper P3-50 2-finger, parallell
W1560640200 Prec.griper P3-64 3-finger, parallell
W1560800200 Prec.griper P3-80 2-finger, parallell
W1561000200 Prec.griper P3-100 2-finger, parallell
W1561250200 Prec.griper P3-125 2-finger, parallell

GRIPFINGER FOR P3/P12

W1560501200 Finger for P3/P12-50, aluminium
W1560641200 Finger for P3/P12-64, stål
W1560801200 Finger for P3/P12-80, stål
W1561001200 Finger for P3/P12-100, stål

Artikkelnr. Benevnelse

GRIPERE 2-FINGER PARALLELL SERIE P4 BRED ÅPNING



W1580100200 Griper 2-finger P4-10, bred åpn.
W1580120200 Griper 2-finger P4-12, bred åpn.
W1580160200 Griper 2-finger P4-16, bred åpn.
W1580250200 Griper 2-finger P4-25, bred åpn.
W1580300200 Griper 2-finger P4-30, bred åpn.

GRIPERE 2-FINGER PARALLELL SERIE P5 TECNO, FOR DIREKTEKOBLING MED RS/S5



W0710010001 Griper P5 tecno, parallell

KOBLINGSELEMENT

W0710040001 Koblingselement R5-S5 tecno
W0710040002 Koblingselement P5/R5-S5 tecno

VINKELGRIPERE SERIE P6



VINKELGRIPERE 30° Ø16

W1500160030 FUL.GR-016-LGH Griper
W1510160030 FUL.GR-016-LGH-M Griper

VINKELGRIPERE 30° Ø20

W1500200030 FUL.GR-020-LGH Griper
W1510200030 FUL.GR-020-LGH-M Griper

VINKELGRIPERE 30° Ø20

W1520200160 FUL.GR-020-HVY Griper
W1530200160 FUL.GR-020-HVY-M Griper

Artikkelnr. Benevnelse

VINKELGRIPERE 30° Ø32

W1500320030 FUL.GR-032-LGH Griper
W1510320030 FUL.GR-032-LGH-M Griper

VINKELGRIPERE 160° Ø32 SERIE P9



W1520320160 FUL.GR-032-HVY Griper
W1530320160 FUL.GR-032-HVY-M Griper

GRIPERE 2-FINGER VINKEL SERIE P7



W1590160200 Griper 2-finger P7-16, vinkel
W1590200200 Griper 2-finger P7-20, vinkel
W1590320200 Griper 2-finger P7-32, vinkel
W1590500200 Griper 2-finger P7-50, vinkel

GRIPERE 2-FINGER VINKEL TECNO SERIE P8



W0710010002 Griper P8-32 tecno, vinkel
W0710010003 Griper P8-40 tecno, vinkel
W0710010004 Griper P8-50 tecno, vinkel

GRIPERE KNELEDD SERIE P10

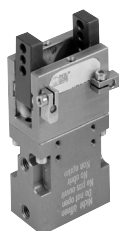

W1590340201 Griper P10-34, Kneledd
W1590440201 Griper P10-44, Kneledd
W1590540201 Griper P10-54, Kneledd
W1590800201 Griper P10-80, Kneledd

Artikkelnr. Benevnelse

GRIPERE 3-FINGER SERIE P11



W1570160300 Griper 3-finger P11-16, parallell
W1570200300 Griper 3-finger P11-20, parallell
W1570250300 Griper 3-finger P11-25, parallell
W1570400300 Griper 3-finger P11-40, parallell
W1570600300 Griper 3-finger P11-60, parallell
W1570800300 Griper 3-finger P11-80, parallell

PRESISJONGRIPERE 3-FINGER SERIE P12



W1560500300 Pres.griper P12-50 3-finger
W1560640300 Pres.griper P12-64 3-finger
W1560800300 Pres.griper P12-80 3-finger
W1561000300 Pres.griper P12-100 3-finger
W1561250300 Pres.griper P12-125 3-finger

GRIPFINGER FOR P3/P12

W1560501200 Finger for P3/P12-50, aluminium
W1560641200 Finger for P3/P12-64, stål
W1560801200 Finger for P3/P12-80, stål
W1561001200 Finger for P3/P12-100, stål
W1561001200 Finger for P3/P12-100, stål

TILBEHØR GRIPERE

MAGNETFØLER FOR P1-P6-P9

W095000252 DCB2C-425 Reedkontakt
W095000253 PNP DCB3N-225 Hallkontakt

MAGNETFØLER FOR P2-P3-P4(16-30) P7-P11-P12

W0950022180 DSL1-C225 NO Reedkontakt
W0950025390 DSL4-N225 NO Hallkontakt
W0950028184 DSL1-C2M8 300mm Reedkontakt
W0950029394 DSL4-N2M8 300mm Hallkontakt

INDUKTIV GIVER FOR P4/12

W0950044180 Ind. giver PNP Ø4, 24VDC 2,5m

INDUKTIV GIVER FOR P3/50-P5-P10-P12

W0950037391 Induktiv giver Ø4mm

DEKKLIST FOR PROFILSPOR

W0950000160 Dekklist for profilspor 500mm



DREIEENHETER

Artikkelnr. Benevnelse

DREIESYLINDER SERIE R1

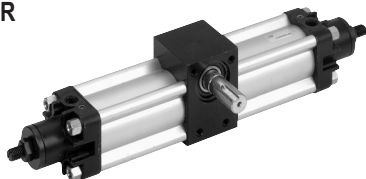

Se side 97

VRIBORD SERIE R2

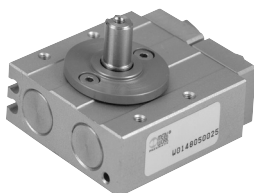

W1620122090	Vribord R2-12-90, aksel
W1620122180	Vribord R2-12-180, aksel
W1620162090	Vribord R2-16-90, aksel
W1620162180	Vribord R2-16-180, aksel
W1620202090	Vribord R2-20-90, aksel
W1620202180	Vribord R2-20-180, aksel
W1620252090	Vribord R2-25-90, aksel
W1620252180	Vribord R2-25-180, aksel

VRIBORD SERIE R3

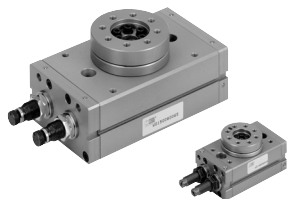

W1630162180	Vribord R3-16-180, flens
W1630163180	Vribord R3-16-180, flens dempn.
W1630202180	Vribord R3-20-180, flens
W1630203180	Vribord R3-20-180, flens dempn.
W1630222180	Vribord R3-22-180, flens
W1630223180	Vribord R3-22-180, flens dempn.
W1630252180	Vribord R3-25-180, flens
W1630253180	Vribord R3-25-180, flens dempn.
W1630302180	Vribord R3-30-180, flens
W1630303180	Vribord R3-30-180, flens dempn.
W1630402180	Vribord R3-40-180, flens
W1630403180	Vribord R3-40-180, flens dempn.

VRIBORD SERIE R4



W1610202090	Vribord R4-20-90
W1610202180	Vribord R4-20-180
W1610322090	Vribord R4-32-90
W1610322180	Vribord R4-32-180
W1610402090	Vribord R4-40-90
W1610402180	Vribord R4-40-180

VRIBORD TECNO SERIE R5

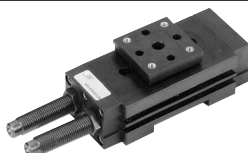

W0710020001	Vribord R5 tecnò
-------------	------------------

TILBEHØR DREIEENHETER

Artikkelnr. Benevnelse

MAGNETFØLER FOR R2(16-20-25)-R4

W0950022180	DSL1-C225 NO Reedkontakt
W0950025390	DSL4-N225 NO Hallkontakt
W0950028184	DSL1-C2M8 300mm Reedkontakt
W0950029394	DSL4-N2M8 300mm Hallkontakt

MAGNETFØLER FOR R3

W0950052185	Reedkontakt 2-tråds NO 1m
-------------	---------------------------

INDUKTIV GIVERE FOR R2/12

W0950044180	Ind. givere PNP Ø4, 24VDC 2,5m
-------------	--------------------------------

DEKKLIST FOR PROFILSPOR

W0950000160	Dekklister for profilspor 500mm
-------------	---------------------------------

GUIDER



Artikkelnr.	Benevnelse
-------------	------------

LINEÆRSTYRING FOR ISO-SYLINDERE SERIE S1

Se side 57 og 76

KORTSLAGSSYLINDER VRISTIV UTFØRELSE SERIE S2

Se side 87

TVILLINGSYLINDER SERIE S3

Se side 78

KOMPAKTSYLINDER VRISTIV UTFØRELSE SERIE S4

Se side 89

TECNO SERIE S5

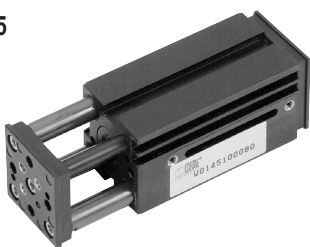

W0710030001 Guide S5 tecno, slagl. 60mm

KOMPAKTGUIDER SERIE S6

Se side 91

Artikkelnr.	Benevnelse
-------------	------------

GUIDE SERIE S7



W149300050	Guide S7 11 S=50, stempelstang løs
W1493000100	Guide S7 11 S=100, stempelstang løs
W1493000160	Guide S7 11 S=160, stempelstang løs
W1493000200	Guide S7 11 S=200, stempelstang løs
W1493000250	Guide S7 11 S=250, stempelstang løs
W1493000320	Guide S7 11 S=320, stempelstang løs
W1493000400	Guide S7 11 S=400, stempelstang løs
W1493000500	Guide S7 11 S=500, stempelstang løs
W1493000600	Guide S7 11 S=600, stempelstang løs
W1493000800	Guide S7 11 S=800, stempelstang løs
W1493001000	Guide S7 11 S=1000, stempelstang løs
W1493001200	Guide S7 11 S=1200, stempelstang løs
W1493001500	Guide S7 11 S=1500, stempelstang løs
W1493002000	Guide S7 11 S=2000, stempelstang løs

W1493010050	Guide S7 11 S=50 belg+stempelstang løs
W1493010100	Guide S7 11 S=100 belg+stempelstang løs
W1493010160	Guide S7 11 S=160 belg+stempelstang løs
W1493010200	Guide S7 11 S=200 belg+stempelstang løs
W1493010250	Guide S7 11 S=250 belg+stempelstang løs
W1493010320	Guide S7 11 S=320 belg+stempelstang løs
W1493010400	Guide S7 11 S=400 belg+stempelstang løs
W1493010500	Guide S7 11 S=500 belg+stempelstang løs
W1493010600	Guide S7 11 S=600 belg+stempelstang løs
W1493010800	Guide S7 11 S=800 belg+stempelstang løs
W1493011000	Guide S7 11 S=1000 belg+stempelstang løs
W1493011200	Guide S7 11 S=1200 belg+stempelstang løs
W1493011500	Guide S7 11 S=1500 belg+stempelstang løs
W1493012000	Guide S7 11 S=2000 belg+stempelstang løs

W149400050	Guide S7 11 ISO Ø32 S=50
W1494000100	Guide S7 11 ISO Ø32 S=100
W1494000160	Guide S7 11 ISO Ø32 S=160
W1494000200	Guide S7 11 ISO Ø32 S=200
W1494000250	Guide S7 11 ISO Ø32 S=250
W1494000320	Guide S7 11 ISO Ø32 S=320
W1494000400	Guide S7 11 ISO Ø32 S=400
W1494000500	Guide S7 11 ISO Ø32 S=500
W1494000600	Guide S7 11 ISO Ø32 S=600
W1494000800	Guide S7 11 ISO Ø32 S=800
W1494001000	Guide S7 11 ISO Ø32 S=1000
W1494001200	Guide S7 11 ISO Ø32 S=1200
W1494001500	Guide S7 11 ISO Ø32 S=1500
W1494002000	Guide S7 11 ISO Ø32 S=2000



Artikkelnr.	Benevnelse
-------------	------------

PRESISJONSSLEIDER SERIE S8

W148C257050	Presisjonsleide S8-C Ø25-0050 mek. stopp
W148C257080	Presisjonsleide S8-C Ø25-0080 mek. stopp
W148C257100	Presisjonsleide S8-C Ø25-0100 mek. stopp
W148C257125	Presisjonsleide S8-C Ø25-0125 mek. stopp
W148C257160	Presisjonsleide S8-C Ø25-0160 mek. stopp
W148C257200	Presisjonsleide S8-C Ø25-0200 mek. stopp
W148C258050	Presisjonsleide S8-C Ø25-0050 stopp+demp
W148C258080	Presisjonsleide S8-C Ø25-0080 stopp+demp
W148C258100	Presisjonsleide S8-C Ø25-0100 stopp+demp
W148C258125	Presisjonsleide S8-C Ø25-0125 stopp+demp
W148C258160	Presisjonsleide S8-C Ø25-0160 stopp+demp
W148C258200	Presisjonsleide S8-C Ø25-0200 stopp+demp
W148C320050	Presisjonsleide S8-C Ø32-0050
W148C320080	Presisjonsleide S8-C Ø32-0080
W148C320100	Presisjonsleide S8-C Ø32-0100
W148C320125	Presisjonsleide S8-C Ø32-0125
W148C320160	Presisjonsleide S8-C Ø32-0160
W148C320200	Presisjonsleide S8-C Ø32-0200
W148C324050	Presisjonsleide S8-C Ø32-0050 brems
W148C324080	Presisjonsleide S8-C Ø32-0080 brems
W148C324100	Presisjonsleide S8-C Ø32-0100 brems
W148C324125	Presisjonsleide S8-C Ø32-0125 brems
W148C324160	Presisjonsleide S8-C Ø32-0160 brems
W148C324200	Presisjonsleide S8-C Ø32-0200 brems
W148C326050	Presisjonsleide S8-C Ø32-0050 dempn..
W148C326080	Presisjonsleide S8-C Ø32-0080 dempn..
W148C326100	Presisjonsleide S8-C Ø32-0100 dempn..
W148C326125	Presisjonsleide S8-C Ø32-0125 dempn..
W148C326160	Presisjonsleide S8-C Ø32-0160 dempn..
W148C326200	Presisjonsleide S8-C Ø32-0200 dempn..
W148C327050	Presisjonsleide S8-C Ø32-0050 mek. stopp
W148C327080	Presisjonsleide S8-C Ø32-0080 mek. stopp
W148C327100	Presisjonsleide S8-C Ø32-0100 mek. stopp
W148C327125	Presisjonsleide S8-C Ø32-0125 mek. stopp
W148C327160	Presisjonsleide S8-C Ø32-0160 mek. stopp
W148C327200	Presisjonsleide S8-C Ø32-0200 mek. stopp
W148C328050	Presisjonsleide S8-C Ø32-0050 stopp+demp.
W148C328080	Presisjonsleide S8-C Ø32-0080 stopp+demp.
W148C328100	Presisjonsleide S8-C Ø32-0100 stopp+demp.
W148C328125	Presisjonsleide S8-C Ø32-0125 stopp+demp.
W148C328160	Presisjonsleide S8-C Ø32-0160 stopp+demp.
W148C328200	Presisjonsleide S8-C Ø32-0200 stopp+demp.
W148C400050	Presisjonsleide S8-C Ø40-0050
W148C400080	Presisjonsleide S8-C Ø40-0080
W148C400100	Presisjonsleide S8-C Ø40-0100
W148C400125	Presisjonsleide S8-C Ø40-0125
W148C400160	Presisjonsleide S8-C Ø40-0160
W148C400200	Presisjonsleide S8-C Ø40-0200
W148C404050	Presisjonsleide S8-C Ø40-0050 brems
W148C404080	Presisjonsleide S8-C Ø40-0080 brems
W148C404100	Presisjonsleide S8-C Ø40-0100 brems
W148C404125	Presisjonsleide S8-C Ø40-0125 brems
W148C404160	Presisjonsleide S8-C Ø40-0160 brems
W148C404200	Presisjonsleide S8-C Ø40-0200 brems

Artikkelnr.	Benevnelse
-------------	------------

PRESISJONSSLEIDER SERIE S8

W148C406050	Presisjonsleide S8-C Ø40-0050 dempn..
W148C406080	Presisjonsleide S8-C Ø40-0080 dempn..
W148C406100	Presisjonsleide S8-C Ø40-0100 dempn..
W148C406125	Presisjonsleide S8-C Ø40-0125 dempn..
W148C406160	Presisjonsleide S8-C Ø40-0160 dempn..
W148C406200	Presisjonsleide S8-C Ø40-0200 dempn..
W148C407050	Prec.slid S8-C Ø40-0050 mek. stopp
W148C407080	Prec.slid S8-C Ø40-0080 mek. stopp
W148C407100	Prec.slid S8-C Ø40-0100 mek. stopp
W148C407125	Prec.slid S8-C Ø40-0125 mek. stopp
W148C407160	Prec.slid S8-C Ø40-0160 mek. stopp
W148C407200	Prec.slid S8-C Ø40-0200 mek. stopp
W148C408050	Prec.slid S8-C Ø40-0050 stopp+demp
W148C408080	Prec.slid S8-C Ø40-0080 stopp+demp
W148C408100	Prec.slid S8-C Ø40-0100 stopp+demp
W148C408125	Prec.slid S8-C Ø40-0125 stopp+demp
W148C408160	Prec.slid S8-C Ø40-0160 stopp+demp
W148C408200	Prec.slid S8-C Ø40-0200 stopp+demp

PRESISJONSSLEIDER SERIE S9

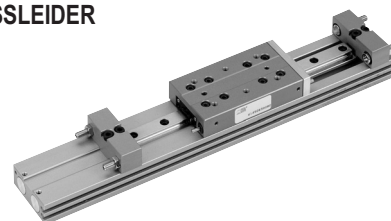

W1470123050	Presisjonsleide S9 Ø12-0050
W1470123075	Presisjonsleide S9 Ø12-0075
W1470123100	Presisjonsleide S9 Ø12-0100
W1470123125	Presisjonsleide S9 Ø12-0125
W1470123150	Presisjonsleide S9 Ø12-0150
W1470125050	Presisjonsleide S9 Ø12-0050 brems
W1470125075	Presisjonsleide S9 Ø12-0075 brems
W1470125100	Presisjonsleide S9 Ø12-0100 brems
W1470125125	Presisjonsleide S9 Ø12-0125 brems
W1470125150	Presisjonsleide S9 Ø12-0150 brems
W1470163050	Presisjonsleide S9 Ø16-0050
W1470163075	Presisjonsleide S9 Ø16-0075
W1470163100	Presisjonsleide S9 Ø16-0100
W1470163125	Presisjonsleide S9 Ø16-0125
W1470163150	Presisjonsleide S9 Ø16-0150
W1470163175	Presisjonsleide S9 Ø16-0175
W1470163200	Presisjonsleide S9 Ø16-0200
W1470165050	Presisjonsleide S9 Ø16-0050 brems
W1470165075	Presisjonsleide S9 Ø16-0075 brems
W1470165100	Presisjonsleide S9 Ø16-0100 brems
W1470165125	Presisjonsleide S9 Ø16-0125 brems
W1470165150	Presisjonsleide S9 Ø16-0150 brems
W1470165175	Presisjonsleide S9 Ø16-0175 brems
W1470165200	Presisjonsleide S9 Ø16-0200 brems
W1470203050	Presisjonsleide S9 Ø20-0050
W1470203075	Presisjonsleide S9 Ø20-0075
W1470203100	Presisjonsleide S9 Ø20-0100
W1470203125	Presisjonsleide S9 Ø20-0125
W1470203150	Presisjonsleide S9 Ø20-0150
W1470203175	Presisjonsleide S9 Ø20-0175
W1470203200	Presisjonsleide S9 Ø20-0200
W1470203250	Presisjonsleide S9 Ø20-0250

Artikkelnr.	Benevnelse
-------------	------------

PRESISJONSSLEIDER SERIE S9

W1470205050	Presisjonsleide S9 Ø20-0050 brems
W1470205075	Presisjonsleide S9 Ø20-0075 brems
W1470205100	Presisjonsleide S9 Ø20-0100 brems
W1470205125	Presisjonsleide S9 Ø20-0125 brems
W1470205150	Presisjonsleide S9 Ø20-0150 brems
W1470205175	Presisjonsleide S9 Ø20-0175 brems
W1470205200	Presisjonsleide S9 Ø20-0200 brems
W1470205250	Presisjonsleide S9 Ø20-0250 brems

DOBBELTSTEMPELSYLINDER SERIE S10

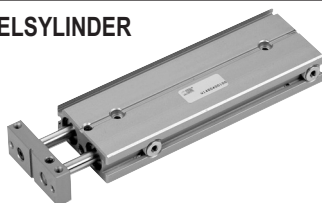

W1440122015	Dobbeltstempelsylinder S10 Ø12-0015
W1440122025	Dobbeltstempelsylinder S10 Ø12-0025
W1440122050	Dobbeltstempelsylinder S10 Ø12-0050
W1440123015	Dobbeltstempelsylinder S10 Ø12-0015 demp.
W1440123025	Dobbeltstempelsylinder S10 Ø12-0025 demp.
W1440123050	Dobbeltstempelsylinder S10 Ø12-0050 demp.
W1440162015	Dobbeltstempelsylinder S10 Ø16-0015
W1440162025	Dobbeltstempelsylinder S10 Ø16-0025
W1440162050	Dobbeltstempelsylinder S10 Ø16-0050
W1440162075	Dobbeltstempelsylinder S10 Ø16-0075
W1440163015	Dobbeltstempelsylinder S10 Ø16-0015 demp.
W1440163025	Dobbeltstempelsylinder S10 Ø16-0025 demp.
W1440163050	Dobbeltstempelsylinder S10 Ø16-0050 demp.
W1440163075	Dobbeltstempelsylinder S10 Ø16-0075 demp.
W1440202025	Dobbeltstempelsylinder S10 Ø20-0025
W1440202050	Dobbeltstempelsylinder S10 Ø20-0050
W1440202075	Dobbeltstempelsylinder S10 Ø20-0075
W1440202100	Dobbeltstempelsylinder S10 Ø20-0100
W1440203025	Dobbeltstempelsylinder S10 Ø20-0025 demp.
W1440203050	Dobbeltstempelsylinder S10 Ø20-0050 demp.
W1440203075	Dobbeltstempelsylinder S10 Ø20-0075 demp.
W1440203100	Dobbeltstempelsylinder S10 Ø20-0100 demp.
W1440252025	Dobbeltstempelsylinder S10 Ø25-0025
W1440252050	Dobbeltstempelsylinder S10 Ø25-0050
W1440252075	Dobbeltstempelsylinder S10 Ø25-0075
W1440252100	Dobbeltstempelsylinder S10 Ø25-0100
W1440252125	Dobbeltstempelsylinder S10 Ø25-0125
W1440253025	Dobbeltstempelsylinder S10 Ø25-0025 demp.
W1440253050	Dobbeltstempelsylinder S10 Ø25-0050 demp.
W1440253075	Dobbeltstempelsylinder S10 Ø25-0075 demp.
W1440253100	Dobbeltstempelsylinder S10 Ø25-0100 demp.
W1440253125	Dobbeltstempelsylinder S10 Ø25-0125 demp.
W1440302025	Dobbeltstempelsylinder S10 Ø30-0025
W1440302050	Dobbeltstempelsylinder S10 Ø30-0050
W1440302075	Dobbeltstempelsylinder S10 Ø30-0075
W1440302100	Dobbeltstempelsylinder S10 Ø30-0100
W1440302125	Dobbeltstempelsylinder S10 Ø30-0125
W1440303025	Dobbeltstempelsylinder S10 Ø30-0025 demp.
W1440303050	Dobbeltstempelsylinder S10 Ø30-0050 demp.
W1440303075	Dobbeltstempelsylinder S10 Ø30-0075 demp.
W1440303100	Dobbeltstempelsylinder S10 Ø30-0100 demp.
W1440303125	Dobbeltstempelsylinder S10 Ø30-0125 demp.

Artikkelnr.	Benevnelse
-------------	------------

DOBBELTSTEMPELSYLINDER SERIE S11

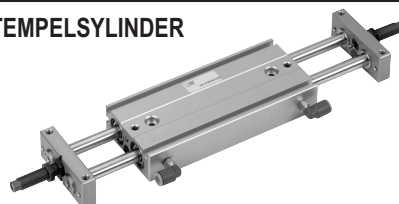

W1450122025	Dobbeltstempelsylinder S11 Ø12-0025
W1450122050	Dobbeltstempelsylinder S11 Ø12-0050
W1450122075	Dobbeltstempelsylinder S11 Ø12-0075
W1450123025	Dobbeltstempelsylinder S11 Ø12-0025 demp.
W1450123050	Dobbeltstempelsylinder S11 Ø12-0050 demp.
W1450123075	Dobbeltstempelsylinder S11 Ø12-0075 demp.
W1450124050	Dobbeltstempelsylinder S11 Ø12-0050 brems
W1450124075	Dobbeltstempelsylinder S11 Ø12-0075 brems
W1450125050	Dobbeltstempelsylinder S11 Ø12-0050 demp+brems
W1450125075	Dobbeltstempelsylinder S11 Ø12-0075 demp+brems
W1450162025	Dobbeltstempelsylinder S11 Ø16-0025
W1450162050	Dobbeltstempelsylinder S11 Ø16-0050
W1450162075	Dobbeltstempelsylinder S11 Ø16-0075
W1450162100	Dobbeltstempelsylinder S11 Ø16-0100
W1450163025	Dobbeltstempelsylinder S11 Ø16-0025 demp.
W1450163050	Dobbeltstempelsylinder S11 Ø16-0050 demp.
W1450163075	Dobbeltstempelsylinder S11 Ø16-0075 demp.
W1450163100	Dobbeltstempelsylinder S11 Ø16-0100 demp.
W1450164050	Dobbeltstempelsylinder S11 Ø16-0050 brems
W1450164075	Dobbeltstempelsylinder S11 Ø16-0075 brems
W1450164100	Dobbeltstempelsylinder S11 Ø16-0100 brems
W1450165050	Dobbeltstempelsylinder S11 Ø16-0050 demp+brems
W1450165075	Dobbeltstempelsylinder S11 Ø16-0075 demp+brems
W1450165100	Dobbeltstempelsylinder S11 Ø16-0100 demp+brems
W1450202025	Dobbeltstempelsylinder S11 Ø20-0025
W1450202050	Dobbeltstempelsylinder S11 Ø20-0050
W1450202075	Dobbeltstempelsylinder S11 Ø20-0075
W1450202100	Dobbeltstempelsylinder S11 Ø20-0100
W1450202125	Dobbeltstempelsylinder S11 Ø20-0125
W1450203025	Dobbeltstempelsylinder S11 Ø20-0025 demp.
W1450203050	Dobbeltstempelsylinder S11 Ø20-0050 demp.
W1450203075	Dobbeltstempelsylinder S11 Ø20-0075 demp.
W1450203100	Dobbeltstempelsylinder S11 Ø20-0100 demp.
W1450203125	Dobbeltstempelsylinder S11 Ø20-0125 demp.
W1450204050	Dobbeltstempelsylinder S11 Ø20-0050 brems
W1450204075	Dobbeltstempelsylinder S11 Ø20-0075 brems
W1450204100	Dobbeltstempelsylinder S11 Ø20-0100 brems
W1450204125	Dobbeltstempelsylinder S11 Ø20-0125 brems
W1450205050	Dobbeltstempelsylinder S11 Ø20-0050 demp+brems
W1450205075	Dobbeltstempelsylinder S11 Ø20-0075 demp+brems
W1450205100	Dobbeltstempelsylinder S11 Ø20-0100 demp+brems
W1450205125	Dobbeltstempelsylinder S11 Ø20-0125 demp+brems
W1450252025	Dobbeltstempelsylinder S11 Ø25-0025
W1450252050	Dobbeltstempelsylinder S11 Ø25-0050
W1450252075	Dobbeltstempelsylinder S11 Ø25-0075
W1450252100	Dobbeltstempelsylinder S11 Ø25-0100
W1450252125	Dobbeltstempelsylinder S11 Ø25-0125



Artikkelnr.	Benevnelse
-------------	------------

DOBBELTSTEMPELSYLINDER SERIE S11

W1450253025	Dobbeltstempelsylinder S11 Ø25-0025 demp.
W1450253050	Dobbeltstempelsylinder S11 Ø25-0050 demp.
W1450253075	Dobbeltstempelsylinder S11 Ø25-0075 demp.
W1450253100	Dobbeltstempelsylinder S11 Ø25-0100 demp.
W1450253125	Dobbeltstempelsylinder S11 Ø25-0125 demp.
W1450253150	Dobbeltstempelsylinder S11 Ø25-0150 demp.

W1450254050	Dobbeltstempelsylinder S11 Ø25-0050 brems
W1450254075	Dobbeltstempelsylinder S11 Ø25-0075 brems
W1450254100	Dobbeltstempelsylinder S11 Ø25-0100 brems
W1450254125	Dobbeltstempelsylinder S11 Ø25-0125 brems
W1450254150	Dobbeltstempelsylinder S11 Ø25-0150 brems

W1450255050	Dobbeltstempelsylinder S11 Ø25-0050 demp+brems
W1450255075	Dobbeltstempelsylinder S11 Ø25-0075 demp+brems
W1450255100	Dobbeltstempelsylinder S11 Ø25-0100 demp+brems
W1450255125	Dobbeltstempelsylinder S11 Ø25-0125 demp+brems
W1450255150	Dobbeltstempelsylinder S11 Ø25-0150 demp+brems

W1450302025	Dobbeltstempelsylinder S11 Ø30-0025
W1450302050	Dobbeltstempelsylinder S11 Ø30-0050
W1450302075	Dobbeltstempelsylinder S11 Ø30-0075
W1450302100	Dobbeltstempelsylinder S11 Ø30-0100
W1450302125	Dobbeltstempelsylinder S11 Ø30-0125
W1450302150	Dobbeltstempelsylinder S11 Ø30-0150

W1450303025	Dobbeltstempelsylinder S11 Ø30-0025 demp.
W1450303050	Dobbeltstempelsylinder S11 Ø30-0050 demp.
W1450303075	Dobbeltstempelsylinder S11 Ø30-0075 demp.
W1450303100	Dobbeltstempelsylinder S11 Ø30-0100 demp.
W1450303125	Dobbeltstempelsylinder S11 Ø30-0125 demp.
W1450303150	Dobbeltstempelsylinder S11 Ø30-0150 demp.

W1450304050	Dobbeltstempelsylinder S11 Ø30-0050 brems
W1450304075	Dobbeltstempelsylinder S11 Ø30-0075 brems
W1450304100	Dobbeltstempelsylinder S11 Ø30-0100 brems
W1450304125	Dobbeltstempelsylinder S11 Ø30-0125 brems
W1450304150	Dobbeltstempelsylinder S11 Ø30-0150 brems

W1450305050	Dobbeltstempelsylinder S11 Ø30-0050 demp+brems
W1450305075	Dobbeltstempelsylinder S11 Ø30-0075 demp+brems
W1450305100	Dobbeltstempelsylinder S11 Ø30-0100 demp+brems
W1450305125	Dobbeltstempelsylinder S11 Ø30-0125 demp+brems
W1450305150	Dobbeltstempelsylinder S11 Ø30-0150 demp+brems

Artikkelnr.	Benevnelse
-------------	------------

TVILLINGSLEIDE SERIE S12



W1460122025	Tvillingsleide S12 Ø12-0025
W1460122050	Tvillingsleide S12 Ø12-0050
W1460122075	Tvillingsleide S12 Ø12-0075

W1460123025	Tvillingsleide S12 Ø12-0025 demp
W1460123050	Tvillingsleide S12 Ø12-0050 demp
W1460123075	Tvillingsleide S12 Ø12-0075 demp

W1460124050	Tvillingsleide S12 Ø12-0050 brems
W1460124075	Tvillingsleide S12 Ø12-0075 brems

W1460125050	Tvillingsleide S12 Ø12-0050 demp+brems
W1460125075	Tvillingsleide S12 Ø12-0075 demp+brems

W1460162025	Tvillingsleide S12 Ø16-0025
W1460162050	Tvillingsleide S12 Ø16-0050
W1460162075	Tvillingsleide S12 Ø16-0075
W1460162100	Tvillingsleide S12 Ø16-0100

W1460163025	Tvillingsleide S12 Ø16-0025 demp.
W1460163050	Tvillingsleide S12 Ø16-0050 demp.
W1460163075	Tvillingsleide S12 Ø16-0075 demp.
W1460163100	Tvillingsleide S12 Ø16-0100 demp.

W1460164050	Tvillingsleide S12 Ø16-0050 brems
W1460164075	Tvillingsleide S12 Ø16-0075 brems
W1460164100	Tvillingsleide S12 Ø16-0100 brems

W1460165050	Tvillingsleide S12 Ø16-0050 demp+brems
W1460165075	Tvillingsleide S12 Ø16-0075 demp+brems
W1460165100	Tvillingsleide S12 Ø16-0100 demp+brems

W1460202025	Tvillingsleide S12 Ø20-0025
W1460202050	Tvillingsleide S12 Ø20-0050
W1460202075	Tvillingsleide S12 Ø20-0075
W1460202100	Tvillingsleide S12 Ø20-0100
W1460202125	Tvillingsleide S12 Ø20-0125

W1460203025	Tvillingsleide S12 Ø20-0025 demp.
W1460203050	Tvillingsleide S12 Ø20-0050 demp.
W1460203075	Tvillingsleide S12 Ø20-0075 demp.
W1460203100	Tvillingsleide S12 Ø20-0100 demp.
W1460203125	Tvillingsleide S12 Ø20-0125 demp.

W1460204050	Tvillingsleide S12 Ø20-0050 brems
W1460204075	Tvillingsleide S12 Ø20-0075 brems
W1460204100	Tvillingsleide S12 Ø20-0100 brems
W1460204125	Tvillingsleide S12 Ø20-0125 brems

W1460205050	Tvillingsleide S12 Ø20-0050 demp+brems
W1460205075	Tvillingsleide S12 Ø20-0075 demp+brems
W1460205100	Tvillingsleide S12 Ø20-0100 demp+brems
W1460205125	Tvillingsleide S12 Ø20-0125 demp+brems

W1460252025	Tvillingsleide S12 Ø25-0025
W1460252050	Tvillingsleide S12 Ø25-0050
W1460252075	Tvillingsleide S12 Ø25-0075
W1460252100	Tvillingsleide S12 Ø25-0100
W1460252125	Tvillingsleide S12 Ø25-0125
W1460252150	Tvillingsleide S12 Ø25-0150

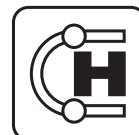

TILBEHØR GUIDER

Artikkelnr.	Benevnelse
-------------	------------

TVILLINGSLID SERIE S12

W1460253025	Tvillingsleide S12 Ø25-0025 demp
W1460253050	Tvillingsleide S12 Ø25-0050 demp
W1460253075	Tvillingsleide S12 Ø25-0075 demp
W1460253100	Tvillingsleide S12 Ø25-0100 demp
W1460253125	Tvillingsleide S12 Ø25-0125 demp
W1460253150	Tvillingsleide S12 Ø25-0150 demp

W1460254050	Tvillingsleide S12 Ø25-0050 brems
W1460254075	Tvillingsleide S12 Ø25-0075 brems
W1460254100	Tvillingsleide S12 Ø25-0100 brems
W1460254125	Tvillingsleide S12 Ø25-0125 brems
W1460254150	Tvillingsleide S12 Ø25-0150 brems

W1460255050	Tvillingsleide S12 Ø25-0050 demp+brems
W1460255075	Tvillingsleide S12 Ø25-0075 demp+brems
W1460255100	Tvillingsleide S12 Ø25-0100 demp+brems
W1460255125	Tvillingsleide S12 Ø25-0125 demp+brems
W1460255150	Tvillingsleide S12 Ø25-0150 demp+brems

W1460302025	Tvillingsleide S12 Ø30-0025
W1460302050	Tvillingsleide S12 Ø30-0050
W1460302075	Tvillingsleide S12 Ø30-0075
W1460302100	Tvillingsleide S12 Ø30-0100
W1460302125	Tvillingsleide S12 Ø30-0125
W1460302150	Tvillingsleide S12 Ø30-0150

W1460303025	Tvillingsleide S12 Ø30-0025 demp
W1460303050	Tvillingsleide S12 Ø30-0050 demp
W1460303075	Tvillingsleide S12 Ø30-0075 demp
W1460303100	Tvillingsleide S12 Ø30-0100 demp
W1460303125	Tvillingsleide S12 Ø30-0125 demp
W1460303150	Tvillingsleide S12 Ø30-0150 demp

W1460304050	Tvillingsleide S12 Ø30-0050 brems
W1460304075	Tvillingsleide S12 Ø30-0075 brems
W1460304100	Tvillingsleide S12 Ø30-0100 brems
W1460304125	Tvillingsleide S12 Ø30-0125 brems
W1460304150	Tvillingsleide S12 Ø30-0150 brems

W1460305050	Tvillingsleide S12 Ø30-0050 demp+brems
W1460305075	Tvillingsleide S12 Ø30-0075 demp+brems
W1460305100	Tvillingsleide S12 Ø30-0100 demp+brems
W1460305125	Tvillingsleide S12 Ø30-0125 demp+brems
W1460305150	Tvillingsleide S12 Ø30-0150 demp+brems

STEMPELSTANGLØSE SYLINDER SERIE S13

Se
side 93

Artikkelnr.	Benevnelse
-------------	------------

MAGNETFØLER FOR S8-S9(16-20)-S10(16-30) S11(16-30)-S12(16-30)

W0950022180	DSL1-C225 NO Reedkontakt
W0950025390	DSL4-N225 NO Hallkontakt
W0950028184	DSL1-C2M8 300mm Reedkontakt
W0950029394	DSL4-N2M8 300mm Hallkontakt

INDUKTIV GIVER FOR S9/12-S10/12-S11/12-S12/12

W0950044180	Ind. giver PNP Ø4, 24VDC 2,5m
-------------	-------------------------------

DEKKLIST FOR PROFILSPOR

W0950000160	Dekklister for profilspor 500mm
-------------	---------------------------------

ØVRIGE TILBEHØR

W0950009001	Sensor sett for S7 guide
W0950009002	Adapterplate for S7 guide
W0950009003	Fotfeste for S7 guide
W0710040002	Koblingsselement P5/R5-S5 tecno

